

DESIGN AND EXPERIMENT OF STEPLESS ADJUSTABLE SOWING AMOUNT HOLE-TYPE METERING WHEEL FOR RICE

水稻播量无级可调型孔式排种轮设计与试验

Xiongfei CHEN^{1,2)}, Haiyang XIA^{1,2)}, Jun'an LIU^{1,2)}, Tuanpeng TU¹⁾, Zeyu SUN^{1,2)}, Jiajia YU^{1,2*)}, Muhua LIU^{1,2*)} ¹

¹⁾ Jiangxi Provincial Modern Agricultural Equipment Key Laboratory, Nanchang 330045, China

²⁾ College of Engineering, Jiangxi Agricultural University, Nanchang 330045, China

*E-mail: aiyejingling@163.com; 714874481@qq.com

DOI: <https://doi.org/10.35633/inmateh-67-39>

Keywords: Direct hill-drop drilling, rice, metering wheel, sowing amount, jogger slider mechanism

ABSTRACT

The performance of hole-type metering device influenced the adaption of different rice varieties in the mechanical direct hill-drop seeding technology, and the stepless adjustable sowing amount hole-type metering wheel was designed to solve this problem. The mechanical characteristics of different seeds were analyzed to acquire the parameters including the hole diameter, the hole depth, number of holes, the diameter of metering wheel and jogger slider mechanism, and the performance of metering wheel was tested on JPS-12 experimental bench by using Yongyou 12, Huanghuazhan and Wanxiang youhuazhan varieties. The hole depth and the rotating speeds of metering wheel were the independence variance, average seeds number per hole, coefficient of variance and cavity rate were taken as the evaluation indexes. The results showed that the metering wheel could sow 3.58~7.82 seeds per hole with less than 40% of coefficient of variance in average seeds number per hole and less than 5% of cavity rate, and the regression model of average seeds number per hole was built by employing the length of seeds, the rotating speed of metering wheel and the hole depth. The correlation coefficient was 0.952, the prediction error of regression mode with 0.32~11.35% was verified by the field experiment. This study could be used for designing the hole-type metering device for rice.

摘要

为提高型孔式水稻穴直播排种器对不同粒型稻种的适应性及播量调节范围, 本文基于型孔深度可调的技术思路, 设计了一种水稻播量无级可调型孔式排种轮; 研究了不同稻种粒形尺寸特征, 确定了型孔直径、型孔深度、型孔数量、排种轮直径、深度调节顶杆滑块机构等关键部件的结构参数; 并以破胸露白稻种甬优 12、黄华占和万象优华占为供试品种, 以排种轮转速和型孔深度为试验因素, 以穴粒数变异系数和空穴率为评价指标, 开展了全因素台架试验, 结果表明, 就 3 种不同粒型供试品种而言, 排种轮在型孔深度 3~8 mm 和排种轮转速 10~90 r/min 的不同组合条件下, 且满足平均穴粒数变异系数小于 40% 和空穴率小于 5%, 可实现平均穴粒数 3.58~7.82 粒/穴可调播种; 同时, 采用逐步回归法, 建立了以稻种长度、排种轮转速和型孔深度为自变量的排种轮平均穴粒数回归模型, 相关系数为 0.952, 进而通过田间试验验证了模型准确性, 模型预测误差为 0.32~11.35%。本文研究结果可为型孔式水稻穴直播排种器开发提供关键部件。

INTRODUCTION

Rice is a very important crop food in the world, and the mechanical hill direct seeding technology of rice is already applied in many countries (Sansen et al., 2019; Sugirbay et al., 2020). It is a simplified planting technology which saves time, reduces labor (Bista et al., 2018), decreases cost and promotes efficiency (Jayalakshmi et al., 2021). While metering device is the key for applying precision hill direct seeding (Singh et al., 2020; Tian et al. 2017), especially for the adaptability of different varieties (Ohno et al., 2018; Kwon et al., 2021; Mahajan et al., 2018), it directly affects the effect of hill direct seeding operation (Kumar et al., 2021; Xing et al., 2020). The hole-type metering device is the most popular application for mechanical hill direct seeding of rice (Cay et al., 2018; Jia et al., 2018).

Luo et al., (2007), developed a hole-type direct metering device with double-filling chamber for rice, and high-speed camera technology was conducted to analyze the flow rule and attitude in the filling area.

¹ Xiongfei Chen, Ph.D., Associate Professor; Haiyang Xia, Master; Jun'an Liu, Ph.D. Lecturer; Tuanpeng Tu, Master; Zeyu Sun, Undergraduate; Jiajia Yu, Ph.D. Lecturer; Muhua Liu, Ph.D., Professor

Yatskul *et al.*, (2017), studied a rice air-seeder with a vertical type divider head and tested distribution accuracy on a standard machine.

Zhang *et al.*, (2018), designed a combined scoop-shaped hole-type metering device with outer wheel and inner wheel to adjust different sowing amount. Wang *et al.*, (2018), controlled the stepper motor by SCM to change the relative angle of inner wheel with outer wheel to change the volume of hole for adjusting the sowing amount. Rajaiah *et al.*, (2020), developed a prototype of a tractor-drawn 9-row precision paddy planter with electronic metering and performed in field. Zhang *et al.*, (2020), developed a U-type chamber metering device to assist in improving the filling performance. As many different rice varieties were used by farmers in China, and the shape characteristics, mechanical and physical characteristics all had a great difference (Mahajan *et al.*, 2018; Tan *et al.*, 2019), while the adaptability and precision of the existing hole-type metering device still needed to be further improved (Wang *et al.*, 2017).

Therefore, a hole-type metering wheel with stepless adjustable sowing amount was designed by changing the hole depth, and the structural parameters including hole diameter, hole depth, number of holes and jogger slider mechanism were determined by theoretical analysis. The study was aimed to improve the adaptability of hole-type hill direct metering device for different varieties and the range of sowing amount.

MATERIAL AND METHODS

Structure and working principle

The stepless adjustable sowing amount hole-type metering wheel for rice was composed of shell, slider, jogger, compression spring, limiting ring of slider, cover, belt pulley, limit ring of bearing, limit top wire, depth adjustable nut, main shaft and other components, as shown in Fig. 1.

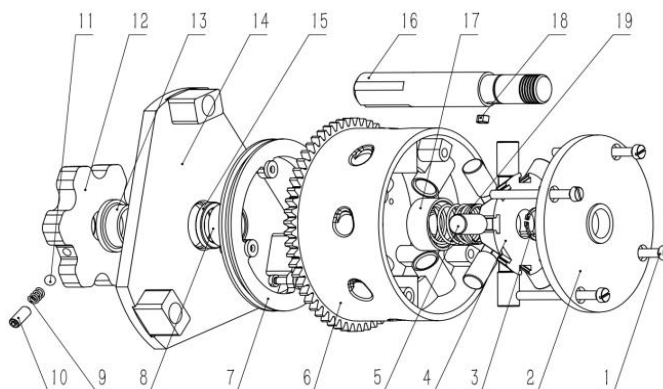

Fig. 1 - Structural diagram of metering wheel

1. Bolt of cover; 2. Cover; 3. Shaft collar; 4. Slider; 5. Jogger; 6. Shell; 7. Belt pulley; 8. Limit ring of bearing; 9. Reset spring; 10. Limit top wire; 11. Limit steel ball; 12. Depth adjustable nut; 13. Limit ring of adjustable nut; 14. Supporting cover; 15. Bearing; 16. Main shaft; 17. Limit ring of slider; 18. Flat key; 19. Compression spring

The joggles were installed to match with holes, and the slider was fixed with joggles, thus the depth adjustable mechanism of jogger slider was developed. Then limit ring of slider and compression spring between the shell and slider were installed in the main shaft, while the limit ring of adjustable nut was installed, and the depth adjustable nut was screwed with the main shaft and positioned by limit steel ball. With the extrusion force of limit steel ball, reset springs and limit top wire, the depth adjustment nut was locked with the main shaft when metering wheel worked.

When the sowing amount increased, the depth adjustable nut turned counterclockwise to release the axial displacement, thus the compression spring would push slider to move left, then the joggles moved radially toward the center of metering wheel, finally the hole depth changed from shallow to deep Fig. 2a.

When the sowing amount decreased, the depth adjustable nut clockwise turned to generate a horizontal axial force, and overcame the elastic force of compression spring, thus the slider could move right, the joggles moved radially toward the edge, and finally the hole depth adjusted from deep to shallow Fig. 2b.

Hole diameter and depth

Two popular holes applied in the direct seeding hole-type metering device of rice were cylindrical shape and spoon shape; and metering wheel adjusted the jogger slider mechanism to change the sowing amount, so the cylindrical hole was selected to promote the application in the field.

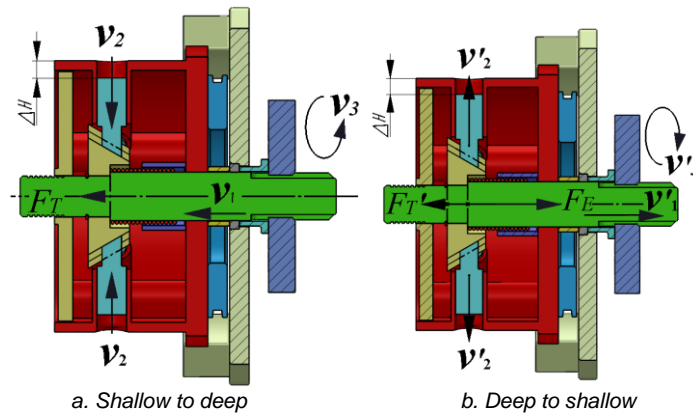

Fig. 2 - Adjusting hole depth of metering device

To determine the hole diameter and depth, the short, medium and long types of rice were included to select, and 50 grains of Yongyou 12, Yongyou 1538, Huanghuazhan, Yexiangyou 2, Wanxiangyouhuazhan and Taiyou 398 were randomly selected to test after pregermination, thus the mechanical characteristics of seeds with length, width, thickness, aspect ratio, slenderness ratio and sphericity were tested to require the parameters of metering wheel respectively with 3 repetitions as shown in Table 1.

Table 1

Material characteristic of different varieties

Varieties	Length /mm	Width /mm	Thickness /mm	Aspect ratio	Slenderness ratio	Sphericity/%
Yongyou 12	7.09	3.33	2.33	2.13	3.04	53.67
Yongyou 1538	8.03	2.87	2.39	2.80	3.36	47.40
Huanghuazhan	9.40	2.00	1.80	4.70	5.22	34.41
Yexiangyou 2	9.92	2.26	1.86	4.39	5.35	34.96
Wanxiangyouhuazhan	11.06	2.28	1.99	4.86	5.57	33.31
Taiyou398	11.29	2.26	2.03	4.99	5.55	33.03

The range of length and thickness were 7.09~11.29 mm and 1.80~2.39 mm, respectively, and the hole diameter was 12 mm for preventing seeds to be stuck, and three postures of seeds were studied during the filling process: lying, standing and erecting, so the hole depth was greater than 2.39 mm to ensure seeds filled completely, so the hole depth was 3.00~8.00 mm.

Number of holes

With the same hill space of seeds and forward speed of machines, when the number of holes increased, the rotating speed decreased, and the filling performance increased. However, the number of holes increased to result in enlarging the diameter of metering wheel or reducing the circumference distance of holes.

So, the formula for number of holes was:

$$N_0 = \frac{\pi d u}{s v} = \frac{60 \pi d u}{s \pi n d} = \frac{60 u}{s n} \tag{1}$$

Where:

- N_0 is the number of holes;
- d - the diameter of metering wheel, m;
- u - the forward speed of machine, m/s;
- v - the linear speed of metering wheel, m/s;
- s - the hill space of seeds, m;
- n was the rotating speed of metering wheel, r/min.

The maximum u in the field was 1 m/s, the minimum s was 0.1 m, and n was no more than 60 r/min, so number of holes N was 8, by calculating.

Diameter of metering wheel

The diameter of metering wheel was the key to determine the structural parameters and influenced the performance. The linear speed of metering device increased with the increase of diameter, and the seeds could not easily fill into the holes, thus cavity rate increased, while reducing the diameter would increase the curvature, and it could result in the worse filling performance (Yi et al., 2021). While the auxiliary filling equipment was not installed, the linear speed was less than 0.35 m/s, so the diameter d was 55 mm.

Hole depth adjustable jogger slider mechanism

The depth adjustable jogger slider mechanism directly adjusted the depth, and the force analysis was required to avoid self-locking and jamming, thus the mechanism could smoothly adjust. When the hole depth changed from shallow to deep, the forces in jogger had the frictional force f_1 between the jogger and the hole, the frictional force f_2 between the jogger and the slider, the support force F_{N1} from metering wheel, the support force F_{N2} from the slider and gravity G_1 , while the joggers were located in the circle of slider, and the resultant force was in the axis direction, thus the force of compression spring balanced. f_1 was from G and F_{N1} , while the jogger mass was made by Polycarbonate having 0.003 kg, and the static friction factor U_s was 0.31, so f_1 had no influence to ignore. The bottom jogger created the most resistance from shallow to deep. Inversely, the top jogger had the largest resistance during changing from deep to shallow.

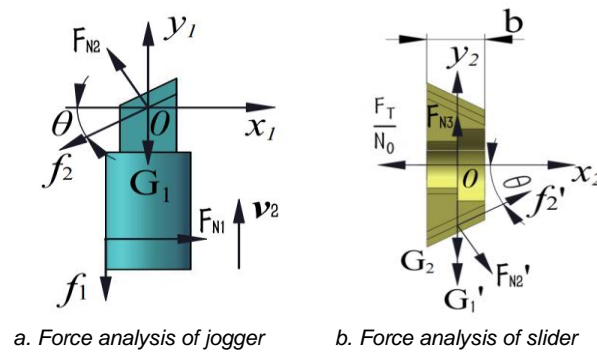

Fig. 3 - Force analysis of jogger slider mechanism

Taking the bottom jogger in slider for force analysis as Fig. 3a, f_1 and f_2 were analyzed in the direction of jogger movement, so the equations were established in (2) as follows:

$$\begin{cases} \sum F_y = 0, F_{N2} \cos \theta - f_2 \sin \theta - G_1 - f_1 = 0 \\ \sum F_x = 0, F_{N1} - F_{N2} \sin \theta - f_2 \cos \theta = 0 \\ f_1 = U_s \cdot F_{N1} \\ f_2 = U_s \cdot F_{N2} \end{cases} \quad (2)$$

Where:

- F_{N1} is the support force from the jogger, N.
- F_{N2} - the support force from the slider, N.
- f_1 - the frictional force between the jogger and the hole, N.
- f_2 - the frictional force between the slider and the jogger, N.
- G_1 - the gravity, N.
- θ - the slope angle of the slider, °.
- U_s - the frictional coefficient.

Adjusting the hole from shallow to deep, the force analysis of slider was applied as shown in Fig. 3b, the x-axis equilibrium equation was established as (3):

$$\sum F_x = 0, f_2' \cos \theta + F_{N2}' \sin \theta - \frac{1}{N_0} \cdot F_T = 0 \quad (3)$$

where: f_2' is the frictional force of slider from the jogger, N.

- F_{N2}' - the pressure of slider from the jogger, N.
- F_T - the recovery elastic of compression spring, N.
- N_0 - the number of holes.

According to Hooke's law:

$$\begin{cases} F_T = k \cdot \Delta x_0 \\ k = \frac{A d_0^4}{8 N_C \cdot D_m^3} \\ \Delta x_0 = \frac{\Delta H}{\tan \theta} \end{cases} \quad (4)$$

Where: k is the spring stiffness coefficient, N/mm.

Δx_0 - the position variable of spring, mm.

A - the stiffness modulus of spring steel, N/mm².

d_0 - the wire diameter of spring, mm.

N_C - the effective number of coils.

D_m - the spring diameter, mm.

ΔH - the depth variable of the hole, mm.

Adjusting the hole depth from shallow to deep, the mechanical model (5) was as follows:

$$\frac{G_1}{F_T} = \frac{\cos \theta - 2U_s \sin \theta - U_s^2 \cos \theta}{N_0 (U_s \cos \theta + \sin \theta)} \quad (5)$$

While adjusting the hole depth from deep to shallow, the same analysis was obtained, and mechanical model (6) was as follows:

$$\frac{G_1}{F_E - F_T'} = \frac{\cos \theta - 2U_s \sin \theta - U_s^2 \cos \theta}{N_0 (U_s \cos \theta + \sin \theta)} \quad (6)$$

Where: F_E is the axial adjustable force, N.

F_T' - the force of compression spring, N.

According to metering wheel, the wire diameter of compression spring d_0 was 2 mm, the spring diameter D_m was 22 mm, the effective number of coils N_C was 14, and the material was carbon spring steel (79000 N/mm²).

The maximum angle θ was 54.70° adjusting the hole from shallow to deep, while the axial force F_E was larger than elastic force of compression spring F_T' , thus the angle θ was no more than 55.55° during changing from deep to shallow, taking the structural parameters, safety coefficient and resistance into consideration, so the angle θ was taken 30°, thus the thickness of slider was 14 mm.

The thickness of slider was calculated as (7):

$$b = \frac{H_{\max}}{\tan \theta} \quad (7)$$

where: b is the thickness of slider, mm. H_{\max} is the maximum hole depth, mm.

Materials and experimental equipment

Three rice varieties of short type Yongyou 12, medium type Huanghuazhan and long type Wanxiang youhuazhan were used in the experiments, and JPS-12 metering device performance test bench was conducted to test the performance, as shown in Fig. 4.



Fig. 4 - JPS-12 performance test bench

Experimental design

Taking Yongyou 12, Huanghuazhan and Wanxiang youhuazhan as experimental materials, the rotating speed of metering wheel 10~ 90 r/min, and the hole depth 3~8 mm as the independence, the full-factor experiment was designed, and 300 holes of seeds were recorded with three repeats.

Evaluation index

Referring to evaluation standard of seeding performance of rice direct seeding machine in DG/T 083-2021, average seeds number per hole L_a , cavity rate H_k and coefficient of variation CV were used as evaluation indexes, and the expressions (8) were as follows:

$$\begin{cases} L_a = \frac{\sum L_i}{L_0} \\ H_k = \frac{K_h}{L_0} \times 100\% \\ CV = \frac{\sigma}{L_a} \end{cases} \quad (8)$$

where:

L_a is the average seeds number per hole, L_i was seeds number of the i hole, L_0 was number of holes.

H_k - cavity rate, K_h – the number of empty holes, CV - coefficient of variation, σ - standard deviation.

RESULTS AND DISCUSSIONS

Effects of different factors for the seeding performance

The results were shown in Table 2. For three varieties, average seeds number per hole increased with the increase of depth, and decreased with the increase of rotating speed. Coefficient of variation of average seeds number per hole decreased with the increase of depth, and increased with the increase of rotating speed. Cavity rate decreased with the increase of depth, and increased with the increase of rotating speed.

Table 2
Effects of seeding performance for different varieties, rotating speed and hole depth on metering wheel

Depth (mm)	Rotating speed (rpm)	Yongyou12			Huanghuazhan			Wanxiangyouhuazhan		
		Average seeds number per hole	CV (%)	Cavity rate (%)	Average seeds number per hole	CV (%)	Cavity rate (%)	Average seeds number per hole	CV (%)	Cavity rate (%)
3	10	5.86	20.61	0.00	4.15	33.75	0.33	3.56	38.44	1.00
	30	5.15	24.96	0.00	3.58	38.22	1.00	2.87	42.73	2.33
	50	4.62	28.86	0.00	2.86	45.50	4.00	2.44	51.49	4.33
	70	4.01	32.40	0.67	2.35	52.04	5.33	1.70	59.99	10.67
	90	3.46	36.02	0.67	1.68	61.89	11.33	1.46	74.21	18.67
4	10	7.68	17.73	0.00	5.58	29.10	0.00	4.22	34.29	0.00
	30	7.05	19.35	0.00	4.79	32.80	0.00	3.56	44.66	1.33
	50	6.67	19.68	0.00	3.91	40.08	0.67	3.04	47.58	2.00
	70	5.41	25.52	0.00	2.54	51.95	3.33	1.89	57.35	8.33
	90	4.48	28.50	0.00	1.92	60.68	8.33	1.58	99.10	17.00
5	10	10.04	15.23	0.00	7.03	26.82	0.00	5.12	34.00	0.00
	30	8.99	18.52	0.00	6.01	28.75	0.00	4.23	38.26	0.67
	50	8.70	17.18	0.00	4.94	36.92	0.00	3.09	52.39	3.33
	70	7.22	20.69	0.00	3.27	51.09	2.33	2.31	62.72	9.33
	90	5.47	26.80	0.00	2.59	60.27	7.33	1.48	78.84	22.00
6	10	11.51	17.16	0.33	8.21	22.09	0.00	5.58	34.14	0.33
	30	10.82	15.52	0.00	6.67	29.89	0.00	4.50	38.00	0.67
	50	9.76	16.25	0.00	5.65	33.98	0.00	3.58	47.68	4.33
	70	7.84	22.07	0.00	3.84	51.55	2.67	2.29	66.02	11.67
	90	6.00	22.36	0.00	2.74	60.71	8.00	1.54	77.38	19.00
7	10	13.30	16.45	0.00	9.90	23.52	0.00	6.64	31.11	0.00
	30	12.37	17.29	0.67	8.06	26.56	0.00	4.79	41.54	1.00
	50	10.79	17.09	0.00	6.37	30.48	0.00	3.77	48.88	1.67
	70	8.46	19.99	0.00	4.49	43.97	1.00	2.63	62.05	8.00
	90	6.93	22.85	0.00	3.12	51.79	3.67	1.56	93.92	27.00

	10	15.21	12.59	0.00	11.58	20.01	0.00	7.82	33.17	0.67
	30	13.99	16.39	0.00	8.54	26.15	0.00	5.87	39.99	0.33
8	50	11.81	17.57	0.00	7.02	30.34	0.00	4.82	44.60	1.00
	70	9.30	22.28	0.00	5.30	37.23	0.33	3.42	58.94	5.67
	90	6.97	26.74	0.00	3.64	48.53	1.67	2.25	65.47	10.67

Influence of different factors on average seeds number per hole

As shown in Fig. 5, for three varieties, with the increase of rotating speed, the increasing range of depth on average seeds number per hole decreased. With the depth of 3~8 mm and the rotating speed of 10~90 r/min, average seeds number per hole in Yongyou 12 was changed from 3.46~15.21 seeds. Huanghuazhan was adjusted from 1.68~11.58 seeds. Wanxiangyouhuazhan was 1.46~7.82 seeds. Therefore, with the depth from 3~8 mm and the rotating speed from 10 to 90 r/min, average seeds number per hole could be adjusted from 3.46~7.82 seeds.

Influence of different factors on the coefficient of variation of the seeds number per hole

With the depth of 3~8 mm and the rotating speed of 10~90 r/min, the coefficient of variation of average seeds number per hole on seeding Yongyou 12 was 12.59-36.02% as shown in Fig.6, while the adjustable range of average seeds number per hole was 3.46~15.21 seeds according to the standard of less than 40%. For Huanghuazhan, the variation coefficient of average seeds number per hole was 20.01~61.89%, and the adjustable range of average seeds number per hole was 3.58~11.58 seeds according to the standard. For Wanxiang youhuazhan, the coefficient of variation of average seeds number per hole was 31.11-99.10%, but the adjustment range of average seed number per hole was 3.56~7.82 seeds with less than 40%.

Therefore, the coefficient of variation of average seeds number per hole was less than 40%, the average seeds number per hole adjusted from 3.58~7.82 seeds under the conditions of depth of 3~8 mm and the rotating speed of 10~90 r/min.

Influence of different factors on cavity rate

It can be seen from Fig. 7 that under the conditions of 3~8 mm depth and 10~90 r/min of rotating speed, for Yongyou 12, the cavity rate was 0~0.67%, and the range of average seeds number per hole, of which cavity rate was less than 5%, was 3.46~15.21 seeds/hole. For Huanghuazhan, cavity rate was 0~11.33%, and the range of average seed number of holes, of which cavity rate was less than 5%, was 2.86~11.58 seeds/hole. For Wanxiangyouhuazhan, the cavity rate was 0~27%, and the range of average seeds number per hole was 2.44~7.82 seeds with less than 5%.

Therefore, for three varieties with different types, based on the standard of cavity rate was less than 5%, under different combination conditions of depth of 3~8 mm and rotating speed of 10~90 r/min, average seeds number per hole could be adjusted from 2.86~7.82 seeds per hole.

To sum up, for three varieties with different types, under different combination conditions of depth of 3~8 mm and rotating speed of 10~90 r/min, it could meet the standards that coefficient of variation of average seeds number per hole was less than 40% and cavity rate was less than 5%. Average seed number per hole could be adjusted from 3.58~7.82 seeds.

Regression model of average seed number per hole

Taking average seeds number per hole as dependent variable, and rotating speed of metering wheel, hole depth, length of seeds, width of seeds, thickness of seeds, aspect ratio of seeds, slenderness ratio of seeds and sphericity of seeds were employed as the independent variables, the stepwise regression method was used to perform multiple linear regression. The model with a higher correlation coefficient R of 0.952 was selected, thus the mathematical model (9) of sowing amount was:

$$y = -0.059x_1 + 0.887x_2 - 1.239x_3 + 15.006 \quad (9)$$

Where: y was average seeds number per hole, x_1 was rotating speed, r/min. x_2 was hole depth, mm, x_3 was length of seeds, mm.

Field experiment

The metering wheel was installed on a high-speed ride-on rice direct seeding machine, and hybrid rice Yexiangyou 2 (length of 9.92 mm) was introduced as the experimental variety.

According to the agricultural requirements for direct seeding in Jiangxi Province, the hill spacing was 16 mm, average number seeds per hole was 3, and forward speed of machine was 1.0 m/s in the field. Meanwhile, the corresponding rotating speed was 48.9 r/min, and the hole depth was 3.71 mm.

Before the field experiment, the forward speeds of high-speed ride-on rice direct seeding machine with 0.77, 0.98 and 1.23 m/s were tested by adjusting the low, medium and high throttle position respectively, and the corresponding rotating speeds were 37.92, 48.35 and 60.24 r/min respectively. Average seeds number per hole within a length of 20 meters in 10 rows was recorded with 3 repetitions as shown in Fig. 8.

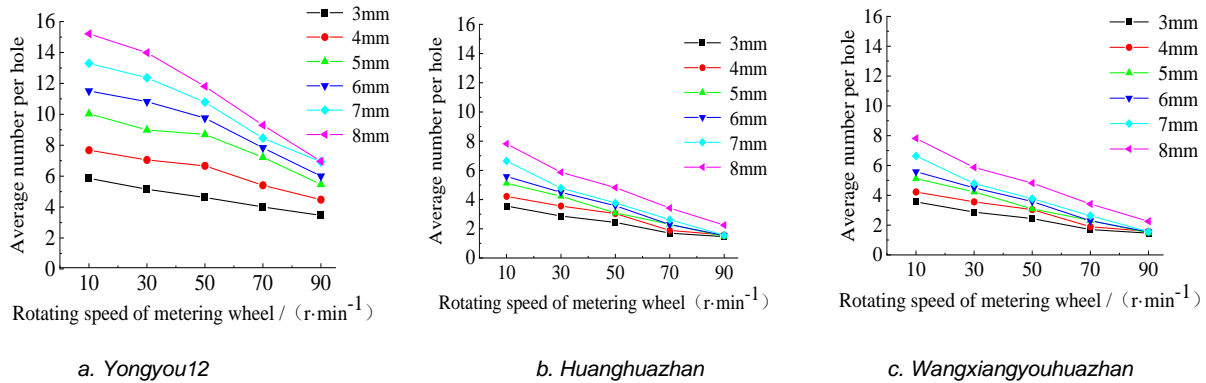

Fig. 5 - Effect of different factors on average seeds number per hole

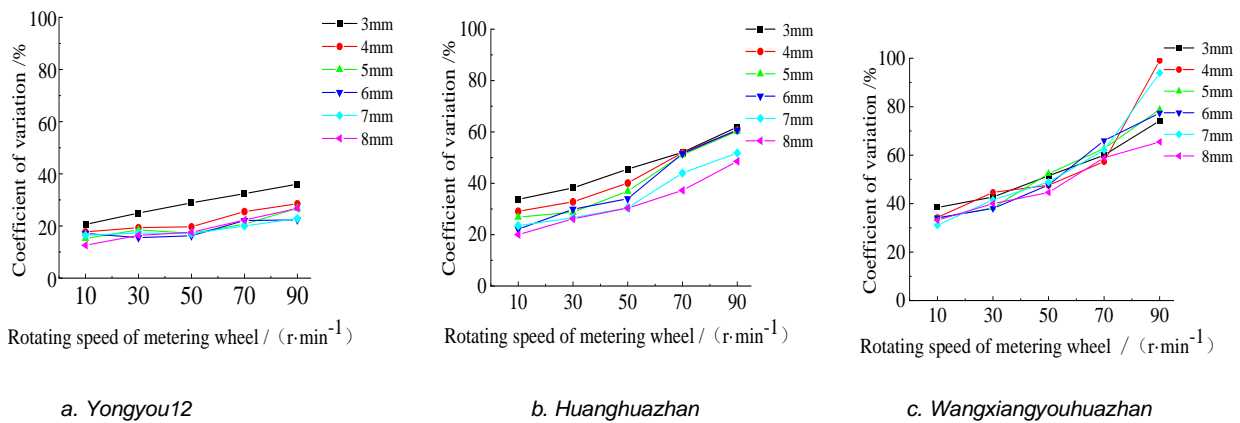

Fig. 6 - Effect of different factors on coefficient of variation of average seeds number per hole

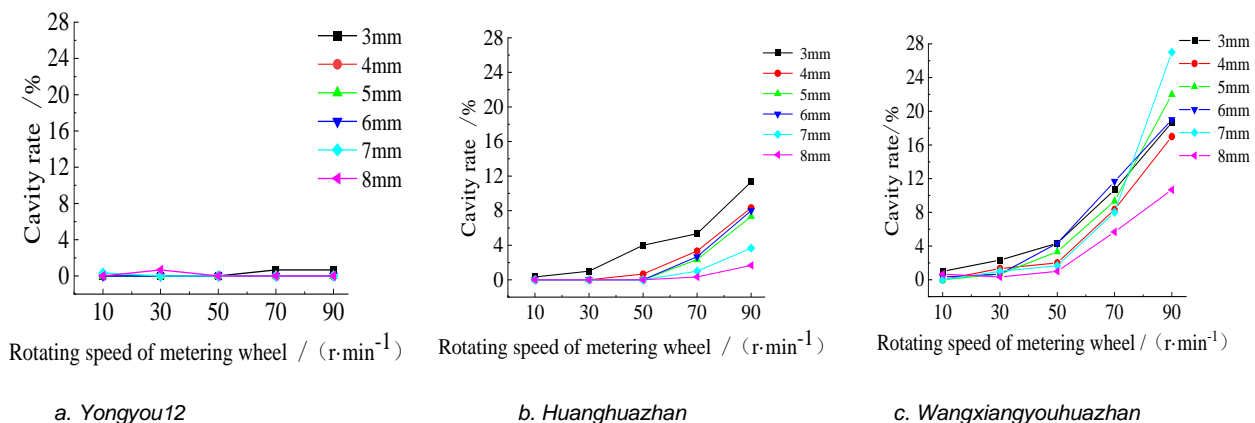

Fig. 7 - Effect of different factors on cavity rate

The results were shown in Table 3. Average seeds number per hole decreased with the increase of rotating speed, which had the same trend as the bench experimental results, meanwhile, the field experimental value was the same as regression model under the same operational conditions, and the prediction error was 0.32~11.35%, so the accuracy of regression model was verified.

Table 3

Test results of field experiment

No	Forward speed / (m·s ⁻¹)	Rotating speed / (r·min ⁻¹)	Model value	Average number Per hole	Error / %
1	0.77	37.92	3.77	3.90	3.45
2	0.98	48.35	3.15	3.14	0.32
3	1.23	60.24	2.45	2.73	11.35



a. Operation site

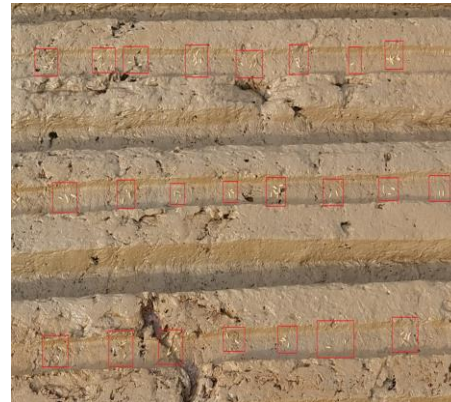

b. Sowing performance

Fig. 8 - Field experiment

CONCLUSIONS

The stepless adjustable sowing amount hole-type metering wheel was designed by changing the hole depth with jogger slider mechanism, and the key parameters were required and tested.

The results showed that for Yongyou 12, Huanghuazhan and Wanxiangyouhuazhan, metering wheel with stepless adjustable sowing amount could sow with average seeds number per hole of 3.58-7.82 seeds under the depth of 3-8 mm and the rotating speed of 10-90 r/min, and it could meet the standard of variation coefficient of average seeds number per hole of less than 40% and cavity rate less than 5%.

The stepwise regression model of average seeds number per hole was established with the length of seeds, the rotating speed of metering device and the hole depth, and the correlation coefficient was 0.952, finally the prediction error of 0.32-11.35% was verified by the field experiment.

ACKNOWLEDGEMENT

This work was supported by Jiangxi Provincial Key Research Project (20201BBF61009), Jiangxi Provincial Agricultural Machinery Equipment Application Industrial Technology Research Systems (JXARS-21).

REFERENCES

- [1] Bista, B. (2018). Direct seeded rice: A new technology for enhanced resource-use efficiency. *International Journal of Applied Sciences and Biotechnology*, Vol. 6(3), 181-198. Nepal.
- [2] Cay, A., Kocabiyyik, H., May, S. (2018). Development of an electro-mechanic control system for seed-metering unit of single seed corn planters Part I: Design and laboratory simulation. *Computers and Electronics in Agriculture*, Vol. 144, 71-79, England.
- [3] Department of Agricultural Mechanization Management, Ministry of Agriculture and Rural Areas, (2021). *Rice direct seeding machine: DG/T 083-2021*. Beijing: China Standards Press.
- [4] Jang, S.-G., S.-Y., Lar, S. M., Zhang, H., Lee, A.-R., Cao, F.-Y., Seo, J., Ham, T.-H., Lee, J., Kwon, S.-W. (2021). Genome-Wide Association Study (GWAS) of Mesocotyl Length for Direct Seeding in Rice. *Agronomy*, Vol. 11(12), 2527, Switzerland.
- [5] Jayalakshmi, M., Chaitanya, B. H., Babu, G. P., Srinivas, T. (2021). Direct seeding through seed drill is advantageous for increasing productivity and profitability of rice (*Oryza sativa*) in western parts of Kurnool District of Andhra Pradesh. *Journal of Krishi Vigyan*, Vol. 10(1), 43-47, India.
- [6] Jia, H. L., Chen, Y. L., GUO, M. Z., Guo, M. Z., Huang, D. Y., Zhuang, J. (2018). Design and key parameter optimization of an agitated soybean seed metering device with horizontal seed filling. *International Journal of Agricultural and Biological Engineering*, Vol. 11(1), 76-87, China.
- [7] Kumar, M., Dogra, R., Narang, M., Singh, M., Mehan, S. (2021). Development and Evaluation of Direct Paddy Seeder in Puddled Field. *Sustainability*, Vol. 13(5), 2745. Switzerland.

- [8] Luo, X. W., Liu, T., Jiang, E. C., Li, Q. (2007). Design and experiment of hill sowing wheel of precision rice direct-seeder (水稻精量穴直播排种轮的设计与试验). *Transactions of the Chinese Society of Agricultural Engineering*, Vol. 23(3), 108-112. Beijing/China.
- [9] Mahajan, G., Singh, K., Singh, N., Kaur, R., Chauhan, B. S. (2018). Screening of water-efficient rice genotypes for dry direct seeding in South Asia. *Archives of Agronomy and Soil Science*, Vol. 64(1):103-115. England.
- [10] Ohno, H., Banayo, N., Bueno, C., Kashiwagia, J., Nakashimaa, T., Iwamaa, K. M., Coralesc, A., Garciad, R., Katobe, Y., (2018). On-farm assessment of a new early-maturing drought-tolerant rice cultivar for dry direct seeding in rainfed lowlands. *Field Crops Research*, Vol. 219, 222-228, Netherlands.
- [11] Rajaiah, P., Mani, I., Parray, R. A., Lande, S. D., Kumar, A., Vergese, C. (2020). Design and development of precision planter for paddy direct seeding. *Journal of Agricultural Engineering*, Vol. 57(4), 302-314, Italy.
- [12] Sansen, K., W., Jairin, J. and Kato, Y. (2019). Farmer-participatory evaluation of mechanized dry direct-seeding technology for rice in northeastern Thailand. *Plant Production Science*, Vol. 22(1), 46-53, Japan.
- [13] Singh, S., Elamathi, S., Ghosh, G., Anandhi, P., Masih, L. P., (2020). Performance of Direct-Seeded Rice as Influenced by Dual Cropping with Nitrogen Levels and Weed Management Practices in Prayagraj Region of Eastern Uttar Pradesh. *National Academy Science Letters*, Vol. 43(5), 399-402.
- [14] Sugirbay, A. M, Zhao, J., Nukeshev, S. O., Chena, J. (2020). Determination of pin-roller parameters and evaluation of the uniformity of granular fertilizer application metering devices in precision farming. *Computers and Electronics in Agriculture*, Vol. 179, 105835, England.
- [15] Tan, Y. Q, Li, Z. J., Chen, L. M., Fang, J. H., Tan, X. M., Wu, Z. M., Zeng, Y. J., Shi, Q. H., Zeng, Y. H. (2019). Screening for direct seeding early rice varieties and their high-yield ability in Northern Jiangxi Province (赣北地区直播早稻品种的筛选及其丰产性研究). *Acta Agriculturae Universitatis Jiangxiensis*, Vol. 41(1), 25-32, Jiangxi/China.
- [16] Tian, L.Q., Tang, H., Wang, J. W., Li, S. W., Zhou, W. Q., Yan, D. W. (2017). Design and Experiment of Rebound Dipper Hill-drop Precision Direct Seed-metering Device for Rice (弹射式耳勺型水稻精量穴直播排种器设计与试验). *Transactions of the Chinese Society for Agricultural Machinery*, Vol. 48(4), 65-72.
- [17] Wang, J. W., Zhou, W. Q., Tian, L. Q., Li, S. W., Zhang, Z. (2017). Virtual simulation analysis and verification of seed-filling mechanism for dipper hill-drop precision direct rice seeder. *International Journal of Agricultural and Biological Engineering*, Vol. 10(6), 77-85, China.
- [18] Wang, Z., Huang, Y., Wang, B., Zhang, M., Ma, Y., Ke, X., Luo, X. (2018). Design and experiment of rice precision metering device with sowing amount stepless adjustment (播量无级调节水稻精量排种装置设计与试验). *Transactions of the Chinese Society of Agricultural Engineering*, Vol. 34(11), 9-16, Beijing/China.
- [19] Xing, H., Zhang, G. Z., Han, Y. H., Gao, Y., Zha, X. T. (2020). Development and experiment of double cavity pneumatic rice precision direct seeder (双腔气力式水稻精量水田直播机设计与试验). *Transactions of the Chinese Society of Agricultural Engineering*, Vol. 36(24), 29-37, Beijing/China.
- [20] Yatskul, A., Lemiere, J. P., Cointault, F. (2017). Influence of the divider head functioning conditions and geometry on the seed's distribution accuracy of the air-seeder. *Biosystems Engineering*, Vol. 161, 120-134, England.
- [21] Yi, S. J., Chen, T., Li, Y. F., Tao, G. X., Mao, X. (2021). Design and Test of Millet Hill-drop Seed-metering Device with Combination of Positive-negative Pressure and Hole Wheel (正负气压-型孔轮组合式谷子穴播排种器设计与试验). *Transactions of the Chinese Society for Agricultural Machinery*, Vol. 52(6), 83-94, Beijing/China.
- [22] Zhang, M. H., Wang, Z. M., Luo, X. W., Ying, Z., Yang, W. W., Xingang, H., Wang, B. L., Dai Y. Z. (2018). Review of precision rice hill-drop drilling technology and machine for paddy. *International Journal of Agricultural and Biological Engineering*, Vol. 11(3), 1-11, China.
- [23] Zhang, S., Li, Y., Wang, H. Y., Liao, J., Li, Z. D., Zhu, D. Q. (2020). Design and Experiment of U-shaped Cavity Type Precision Hill-drop Seed-metering Device for Rice (U型腔道式水稻精量穴播排种器设计与试验). *Transactions of the Chinese Society for Agricultural Machinery*, Vol. 51(10), 98-108, Beijing/China.