

GSM WiFi MOBILE COMMUNICATION SYSTEM FOR AGRICULTURAL VEHICLES /

SISTEM DE COMUNICAȚIE MOBIL, GSM-WIFI, PENTRU VEHICULELE AGRICOLE

Mario CRISTEA ¹⁾, Mihai Gabriel MATACHE ¹⁾ Claudia IONIȚĂ ^{*2)}; Lucian Andrei PERIȘOARĂ ²⁾,
Robert Dorin CRISTEA ²⁾, Vlad Nicolae ARSENOAIA ³⁾

¹⁾ INMA Bucharest / Romania;

²⁾ Politehnica University of Bucharest / Romania

³⁾ Life Sciences University named "Ion Ionescu de la Brad", Iasi / Romania

E-mail: claudia_c_ionita@yahoo.com

DOI: <https://doi.org/10.35633/inmateh-67-02>

Keywords: WiFi Communication, Geographic positioning system, GSM technology, Mobility

ABSTRACT

The research carried out in this paper aimed to create a communication network for a fleet of agricultural vehicles by means of which to transmit and receive information on the status of work, working time, processed areas, number of machines used and much more necessary information. Communication is based on GSM and WiFi standards, which bring the most secure security standards in data protection to this network. The major advantage of the solution presented is that all the important information is concentrated in one place. The proposed communication system consists of a mobile device that routes the WiFi network on a GSM network that has a minimum 3G standard but also works with 5G, depending on the GSM operator and the devices that are mounted on vehicles, which communicate over the WiFi network. The communication device was mounted on an electric tractor, where it was powered by the tractor's power source. In this communication architecture, the vehicle transmitted information to a control centre and also to other vehicles in the vicinity. The system was able to receive data from other devices, authorized in the system, which could be fixed in the field. The collected data were transmitted to a server in a remote location. The obtained results showed a decrease of signal strength while getting further away from the tractor, with good results up to 100 m radius.

REZUMAT

Cercetările realizate în cadrul prezentei lucrări urmăresc modul de realizare a unei rețele de comunicație pentru o flotă de vehicule agricole cu ajutorul căreia pot fi transmise și recepționate informații despre stadiul lucrărilor, timpii de lucru, suprafețele lucrute, numărul de utilaje folosite și multe alte informații necesare echipei de coordonare a flotelor. Comunicarea este bazată pe standardele GSM și WiFi care aduc în această rețea cele mai sigure standarde de siguranță în protecția datelor. Avantajul major a soluției prezentate este acela că toate informațiile importante sunt concentrate într-un singur loc. Sistemul de comunicație propus este alcătuit dintr-un dispozitiv mobil care face rutarea rețelei WiFi pe o rețea GSM ce are ca standard minim 3G dar funcționează și cu 5G, depinzând de operatorul GSM și de dispozitivele care sunt montate pe vehicule, acestea comunicând pe rețeaua WiFi. Dispozitivul de comunicație a fost montat pe un tractor electric, unde a fost alimentat de la sursa de energie a tractorului. În această arhitectură de comunicație, vehiculul a transmis informații către un centru de control dar și către alte vehicule aflate în vecinătate. Sistemul a fost capabil să primească date și de la alte dispozitive, autorizate în sistem, care puteau avea poziții fixe în teren. Datele colectate au fost transmise la un server aflat într-o locație îndepărtată. Rezultatele obținute au arătat o scădere a puterii semnalului pe măsura ce ne îndepărtăm de tractor, cu rezultate bune până la o rază de 100 m.

INTRODUCTION

As a result of the growing demand for food, the profitability of agricultural production is also increasing and support in this respect is being provided by digital technologies with which precision agriculture can be achieved. The new electronic devices, microcontrollers, process computers (made with Programmable Logic Controllers) and the variety of sensors that can be mounted on these devices have led to an explosion of hardware/software solutions, both in terms of air and ground data collection, real position in the field by means of GPS but also an increase in the complexity of information that can be transmitted in real time with the help of wireless networks. This exchange of information, fast and of high volume leads to an efficiency of the work in the field but also to the planning of the operations within the farms. The transmission of the most accurate information in the field makes it possible to create reports and statistics on the agricultural vehicle fleet, work maps and databases can be created for further evaluation of the works.

In agriculture, different systems for collecting data about soil or air are used; they use WiFi with different protocols, and the data obtained end up on a server or in the cloud to be processed. (Amine *et al.*, 2022). The use of new technologies in agriculture allows the use of remote control technologies so that an increase in efficiency and accuracy can be achieved in agricultural work, thus the management of resources is much simpler, also a number of automated systems, intended for routine work or for situations in which human personnel are unable to intervene, can be achieved (Jinyuan *et al.*, 2022).

The literature describes the use of nodes and smart sensors that have low production costs. Thus, devices that allow creating irrigation systems at affordable prices that can be used by farmers were created. These devices are based on microcontrollers such as: Arduino Uno, Arduino Mega, Node MCU, WEMOS Mini D1, Raspberry Pi 2, Model B and Raspberry Pi 3 Model B+. Also, the nodes thus designed can control actuators or solenoid valves, used for opening and closing water circuits or for operating systems that have the role of controlling the environment (Lloret *et al.*, 2021).

One of the problems with wireless networks is the disconnection, which leads to data loss or increased traffic as a result of packets of information that need to be resent. There are many studies that explain how radio connection interruption can be avoided or reduced by optimizing the transmission or communication strategies that minimize the time required for devices to transmit data over the network (Girolami *et al.* 2022). Mathematical algorithms can also be used to simulate data traffic in wireless networks to which the connection also depends on the connection time to allocate traffic so that the number of lost connections is as low as possible (Ceselli *et al.*, 2018).

The microcontrollers used in such systems act as two-way communication with a command centre that can be a PC or a WEB server running a database, such as MySQL, or on which is implemented a software intended for the communication with the sensors it is connected to. The sensors can use the serial bus with different hardware configurations and protocols such as RS-232, RS-422, RS-423, I2C, Profibus and others to communicate with the microcontroller.

Modules for monitoring soil parameters have been developed with the help of low-cost microprocessors and sensors; these modules can provide information about soil moisture and temperature. The modules use PIC16F877A microcontrollers, an LM 35 temperature sensor, a humidity sensor, a PIR sensor (passive infrared sensor) and a GSM module for communication. These modules have the advantage of very low cost, low maintenance and high reliability (Suma *et al.*, 2017).

There are projects that aim to develop embedded systems, which have support for radio, Wi-Fi, Bluetooth and GSM communications, which connect to a central node that has a very high capacity for data storage and processing and the results or reports can be viewed in real time on any device with internet access (Julian *et al.*, 2020).

Concern for the development of low-consumption circuits and systems is present in all fields, research in the field of electronics has increased the energy efficiency of electronic components. The development of intelligent systems capable of fast communications and low energy consumption are factors that drive the implementation of the concepts of Industrial IoT and Industry 4.0 (Sisinni *et al.*, 2018).

By using these integrated communication and data acquisition systems, farmers are able to assess the soil profile themselves and thus they are able to plan future crops correctly. These systems are capable of transmitting, generating reports and creating databases with fuel consumption, energy, tank fluid level, vehicle operating hours, working time for the driver, travelled distance, speed (there are situations when speed is an important factor), processed areas, harvested quantity, how to use the vehicle, errors and breakdowns that occur during operation.

MATERIALS AND METHODS

The communication system is based on a mobile router (RBwAPR-2nD) that switches from GSM to WiFi. It contains a 650 Mhz Qualcomm Atheros QCA953 microprocessor, 64 Mb RAM and 16 Mb flash memory (<https://mikrotik.com/product/RBwAPR-2nD>).

It connects all the devices needed to transmit to a control and monitoring centre. The data that are transmitted depends on these devices and they are designed as to be chosen according to farmers' needs.

The router is designed as a mobile device, so the box in which it is mounted also contains a power supply system based on a 12V battery. The device can be mounted on any agricultural vehicle, if it also has a 12V power supply circuit which can power the router and even charge its battery. The block diagram of the router is detailed in Fig. 1.

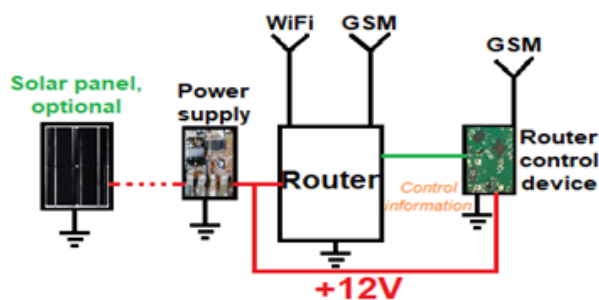

Fig. 1 - Block diagram of the mobile router

The experiments were performed with the router mounted on a fully electric agricultural tractor. The tractor was equipped with a Raspberry Pi 4 to which a GPS module, a video camera and a communication module on the CAN bus were connected, with the help of which the microcontroller receives data on the battery status and the operation mode of the engine. The router is capable of handling up to 253 IP addresses. The transfer speed will be divided between all the devices that will be connected to the router so the modules that are mounted in the field must be designed so that the data traffic through the router is within a reasonable limit so as not to reach the upper transfer speed limit of the router. Normally the volume of data through the router will not exceed 10-20 Mbs, a transfer speed also supported by the GSM network without being overloaded.

The router used (4G LTE Secutron LS-1 External Modem) was developed by MikroTik, a company that made both the hardware and the software. It is capable of a maximum transfer rate of 300 Mbs and the standards accepted in the WiFi network are 802.11b / g / n.

Table 1

Secutron LS-1 wireless specifications (MikroTik, 2022)

2.4 GHz	Transmit (dBm)	Receive Sensitivity (dBm)
1MBit/s	22	-96
11MBit/s	22	-89
6MBit/s	20	-93
54MBit/s	18	-74
MCS0	20	-93
MCS7	16	-71

The communication set consists of a wireless Access Point to which the GSM card is mounted and depending on the operator it can transmit on 2G, 3G, or 4G. Another module to which another GSM card can be mounted is used to remotely control the router using the predefined commands that are detailed in the router’s manual. Figure 2 shows in detail how the circuits are located inside the protection box.



Fig. 2 – Mounting of the Access Point and the remote control board in the box

The router was placed in the front part of the tractor next to the engine controller, see Fig. 3, so it was protected from water and dust, but since the signal may be attenuated by the hood which is made of metal, therefore it was also placed on the cab roof, see Fig. 4.



Fig. 3 - Physical placing of the router in the tractor

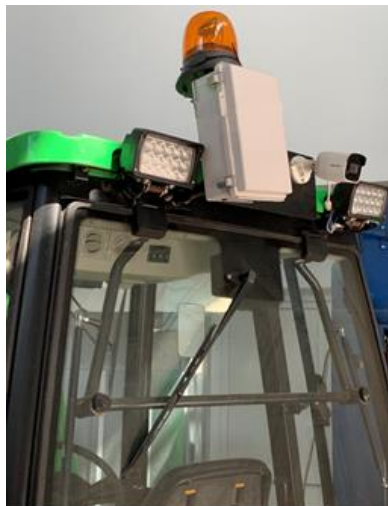

Fig. 4 - Router placing on the tractor cab

The operating system of the router was RouterOS version 6.45.9, an operating system that can be installed on a PC and thus it can be turned into a router with all the necessary features - routing, firewall, bandwidth management, wireless access point, hotspot gateway, VPN server and more. The home page of the router is shown in Fig. 5.

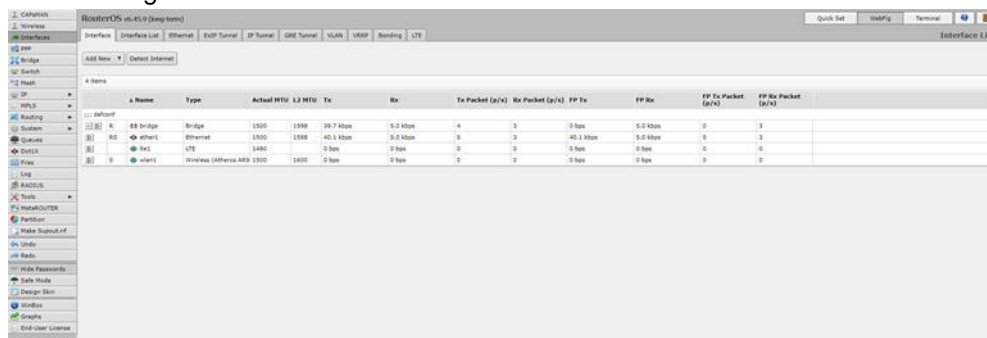

Fig. 5 - Home page when connecting to the router

RouterOS could be configured in a variety of ways, such as local access with keyboard and monitor, serial console with a terminal application, network access, and secure Telnet and SSH, using a custom interface (GUI) called Winbox, or a simple interface based on Web but also an Application Programming Interface (API) for building custom control applications. If there is no local access or IP connection issues,

RouterOS also supports a MAC connection by means of custom Mac-Telnet and Winbox programs. A part of the configuration menu is shown in Figs. 6, 7 and 8.

RouterOS provides an integrated firewall that performs packet routing, IP address filtering, address range, port, port range, IP protocol, DSCP, supports static and dynamic address lists.

Supported router protocols were:

- RIP v1 and v2, OSPF v2 and BGP v4 are supported for IPv4.
- RIPng, OSPFv3 and BGP are supported for IPv6.

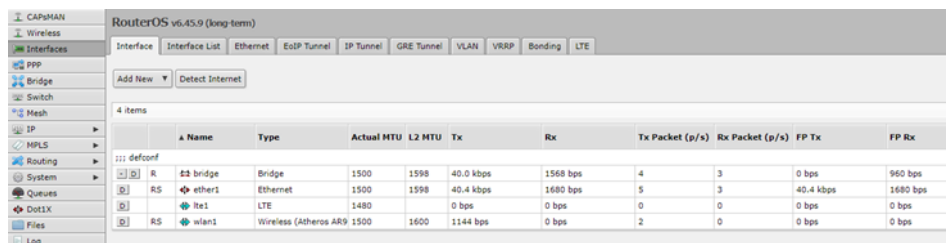

	Name	Type	Actual MTU	L2 MTU	Tx	Rx	Tx Packet (p/s)	Rx Packet (p/s)	FP Tx	FP Rx	
defconf	R	bridge	Bridge	1500	1598	40.0 kbps	1568 bps	4	3	0 bps	960 bps
ether1	RS	ether1	Ethernet	1500	1598	40.4 kbps	1680 bps	5	3	40.4 kbps	1680 bps
lte1	RS	lte1	LTE	1480	1600	0 bps	0 bps	0	0	0 bps	0 bps
wlan1	RS	wlan1	Wireless (Atheros AR9)	1500	1600	1144 bps	0 bps	2	0	0 bps	0 bps

Fig. 6 - Interface configuration menu

Most of the existing wireless technologies are currently supported in RouterOS, the main ones being the Access Point and the wireless client. It can be used both in small networks and at metropolitan level.

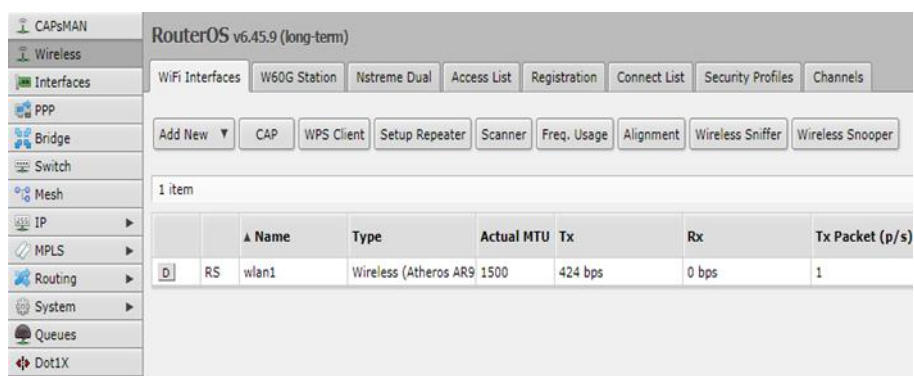

	Name	Type	Actual MTU	Tx	Rx	Tx Packet (p/s)
RS	wlan1	Wireless (Atheros AR9)	1500	424 bps	0 bps	1

Fig. 7 - WiFi configuration menu

Wireless protocol functions implemented in RouterOS:

- IEEE802.11a / b / g / n wireless client and access point
- Nstreme and Nstreme2 proprietary protocols
- Customer survey
- RTS / CTS
- Wireless Distribution System (WDS)
- Virtual AP
- WEP, WPA, WPA2 encryption
- Access control list
- Wireless client roaming
- WMM
- Wireless HWMP + MESH protocol
- MME wireless routing protocol

The gateway allows providing access to the public network for customers who use wired or wireless network connections. Once a username and password are provided, the user will be allowed access to the internet. No software installation or network configuration is required.

RouterOS supports a large number of network tools needed to configure, monitor, or optimize the network. Tools included in RouterOS are:

- Ping, traceroute
- Bandwidth test, ping flood
- Dynamic DNS updater
- VRRP redundancy support
- SNMP for providing graphs and stats

- RADIUS client and server (User Manager)
- Telnet, SSH
- SMS send tools
- Packet sniffer
- Active connection table
- NTP Client and Server
- TFTP server



Fig. 8 - Tools menu

From the Tools menu, all router parameters are configured, modified or monitored. As can be seen in Fig. 8, the menu is well structured and, in each menu, when activated, a series of very intuitive submenus appear and they can be understood even by operators without much experience in this software.

RouterOS configuration documentation is available on the manufacturer’s website and can be accessed using <https://mikrotik.com/software>.

The Raspberry microcontroller, Fig. 9, which was mounted on tractor board, uses a 7-inch display while a wireless mouse and keyboard are used for programming.



Fig. 9 - Raspberry Pi 4

The operating system used on the Raspberry Pi was Raspberry Pi OS, installed on a 16Gb SD card. Raspberry connected to the mobile router to transmit pre-programmed data to a website is shown in

Fig. 10.

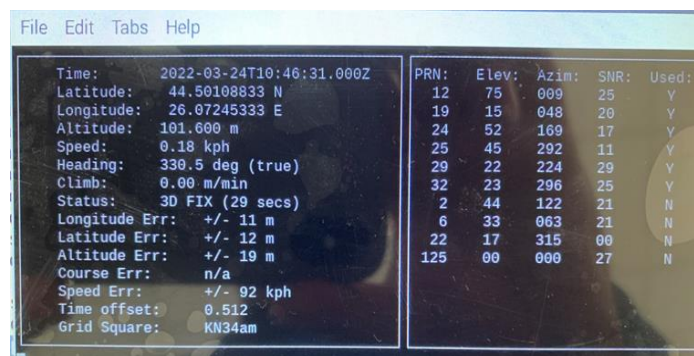

Fig. 10 - GPS position displayed by Raspberry PI

Transmitted data represented the GPS position of the tractor in the field, technical indicators of the electric propulsion system or of the equipment that is coupled to the tractor, the battery power level, the estimated operating time and the use of the tractor, as shown in Fig. 11. An example of visualization in google maps is presented in Fig. 12.

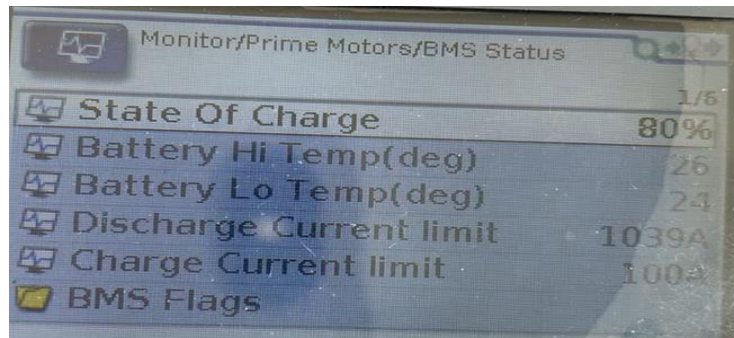

Fig. 11 - Data sent by the engine controller to the Raspberry Pi via the CAN bus

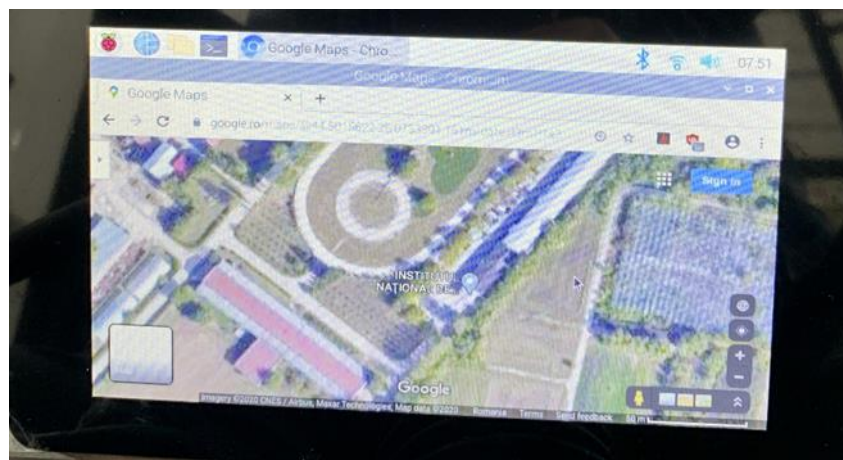

Fig. 12 - Use of GPS coordinates to display one's position on Google Maps with the Raspberry Pi microcontroller mounted on tractor board

Fig. 13 shows that when the tractor is in motion, all devices that are located in the field and have the ability to connect to a WiFi network, supported by the router, connect to the router as they manage to establish a stable connection and thus these devices can transmit information from connected sensors but may also receive data packets that may contain configuration or command information from a dedicated server.

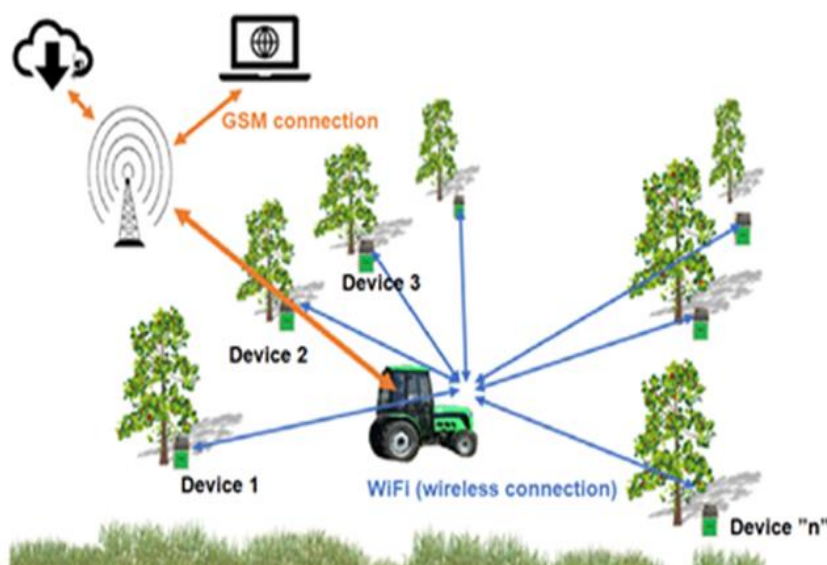

Fig. 13 - Way of connecting devices to the router and to the internet

Such a mobile router can provide coverage of approximately 31,400 square meters. If the devices fixed in the ground are on a larger surface, it is necessary to increase the number of routers so that the coverage is maximum.

RESULTS

The results of the signal level measurement were performed using a mobile phone that was connected to the router. The latter was able to indicate the level of signal provided to any device that was connected to it. The signal level was displayed by the router itself, as illustrated in Fig. 14.

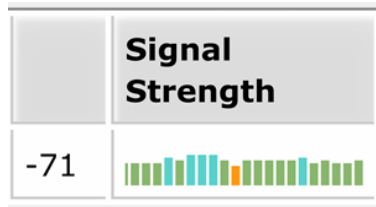

Fig. 14 - Signal level with the router connected to a single device

The measurements were made in a straight line with the tractor on a flat surface without obstacles between the router and the connected device. The following table shows the signal values between the router and the device and are displayed using the software implemented in the router.

Table 2

Distance (m)	10m	15m	25m	50m	100m
Measured value (dB)					
Engine compartment, front	-69	-73	-81	-83	-84
Engine compartment, left and right side	-70	-72	-82	-83	-86
Engine compartment, rear	-74	-79	-82	-83	-86
Front roof	-64	-68	-69	-79	-85
Side roof (left/right)	-63	-75	-67	-80	-87
Rear roof	-59	-59	-63	-65	-82

The router has the ability to provide traffic information for each connected device. This can be helpful when calculating the amount of data traffic required for existing devices in the field.

Fig. 15 and 16 show how the network signal decreases as one moves away from the router.

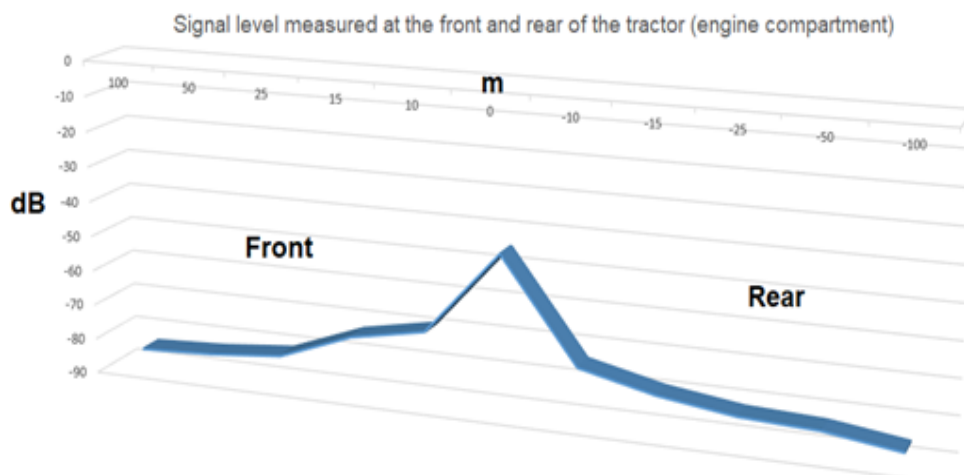

Fig. 15 - Signal level measured at the front and rear of the tractor (dB)

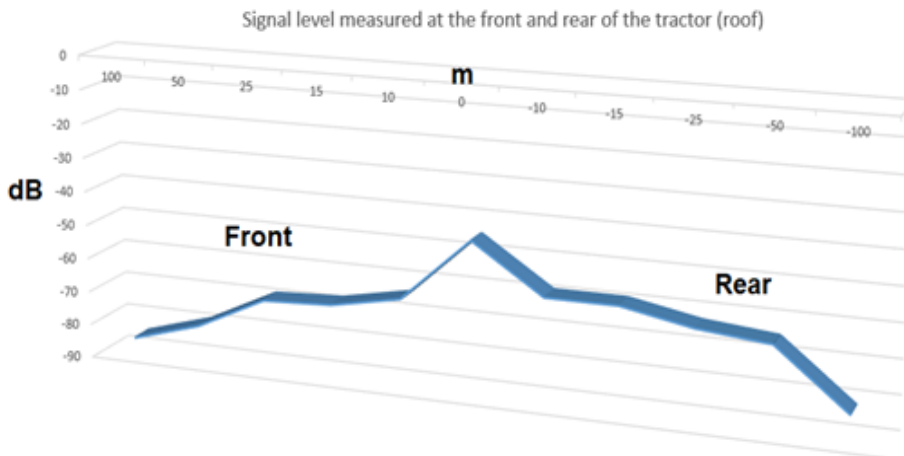

Fig. 16 - Signal level measured at the front and rear of the tractor (roof, dB)

The data transfer rate of the router is limited by the transfer rate provided by the GSM service provider in the area where the router operates.

Below is shown the router traffic without a GSM internet connection (Fig. 17). It is only the traffic that is generated in the WiFi network between the connected devices and the router.

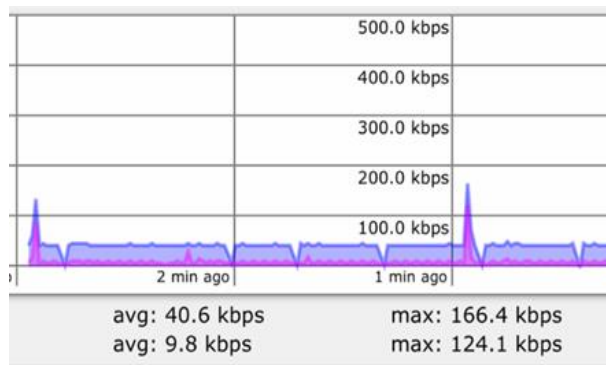

Fig. 17 - Real-time data traffic report with no internet connection

The data transfer to the internet depends a lot on the GSM service provider. The router is capable of a theoretical GSM transfer speed that can exceed 200 Mbps.

It is found that when the router is mounted in front, inside the engine compartment, although it is more protected from solar radiation or precipitation, the hood acts as an electromagnetic shield and thus the range of the router decreases.

Indoor antennas were used, mounted in the protection box of the router, but in order to increase the range of the router, external antennas could be mounted with an increased signal gain.

CONCLUSIONS

The communication system proposed could be used as a mobile relay that connects to the internet the devices that communicate in the WiFi network but also as a fixed relay for devices mounted in the field. The area covered is large enough to be used by a relatively large number of agricultural vehicles to transmit information that is considered useful in real time to a web server or cloud service.

When used on an agricultural vehicle, the power is supplied from the vehicle system, 12V, but it also has a battery to be used even if the vehicle has been stopped. Battery life is 5 days with 22 hours of operation per day.

The device can be used with solar power to increase the autonomy of operation. When it is used as a fixed access point and is powered by a solar station, the usage time can reach from a few months to even a few years without maintenance.

The usefulness of such a device can be highlighted especially on agricultural areas located in places where the internet connection is difficult or requires large investments in communication infrastructure.

ACKNOWLEDGEMENT

This work was supported by a grant of the Romanian Ministry of Education and Research, CCCDI - UEFISCDI, project number PN-III-P2-2.1-PED-2019-2862, contract 483PED, project name: Remote Monitoring System for Electric Vehicles using IoT Technologies, within PNCDI III.

REFERENCES

- [1] Amine F., Mohamed S., Essaid S. (2021). An Agile AI and IoT-Augmented Smart Farming: A Cost-Effective Cognitive Weather Station. *Agriculture*. MDPI, *Agriculture 2022*, Switzerland, p.10. <https://doi.org/10.3390/agriculture12010035>
- [2] Ceselli A., Fiore M., Premoli M., Secci S. (2018). Optimized assignment patterns in Mobile Edge Cloud networks. *Computers and Operations Research*, Volume 106, pp. 246-259. DOI: 10.1016/j.cor.2018.02.022
- [3] Girolami M., Vitello P., Capponi A., Fiandrino C., Foschini L., Bellavista P., (2022). A mobility-based deployment strategy for edge data centres. *Journal of Parallel and Distributed Computing*, Volume 164, pp. 133 - 141. DOI: 10.1016/j.jpdc.2022.03.007
- [4] Lloret J., Sendra S., Garcia-Fernandez J., Garcia L. and Jimenez J. (2021). A WiFi-Based Sensor Network for Flood Irrigation Control in Agriculture. *MDPI, Electronics 2021*, 10(20), 2454. <https://doi.org/10.3390/electronics10202454>
- [5] Jinyuan X., Baoxing G., Guangzhao T. (2022). Review of agricultural IoT technology. *Artificial Intelligence in Agriculture*, Volume 6, pp. 10-22. <https://doi.org/10.1016/j.aiia.2022.01.001>
- [6] Julian J. M., Orosco E. C., Soria C. M. (2020). Multi-Sensor Embedded System with Multiple Communications Based on EDU-CIAA. *IEEE Latin America Transactions*, volume 18, Issue 2, pp. 368 - 375. DOI 10.1109/TLA.2020.9085292
- [7] Sisinni E., Saifullah A., Han S., Jennehag U. (2018). Industrial internet of things: Challenges, opportunities, and directions. *IEEE Transactions on Industrial Informatics*, Volume 14, Issue 11, pp. 4724 – 4734, Article number 8401919. DOI: 10.1109/TII.2018.2852491
- [8] Suma N., Samson S., Saranya S., Shanmugapriya G., Subhashri R. (2017). IOT Based Smart Agriculture Monitoring System. *International Journal on Recent and Innovation Trends in Computing and Communication*, p. 5. DOI: 10.35940/ijitee.i7142.079920
- [9] *** MikroTik, <https://mikrotik.com/>
- [10] *** TP-Link Technologies Co., Ltd., www.tp-link.com/us/