

**RESEARCH ON SHREDDED BIOMASS DRYING IN
A VIBRATING FLUIDIZED BED DRYER
/
CERCETARI PRIVIND USCAREA BIOMASEI MARUNTITE
INTR-UN USCATOR CU PAT FLUIDIZAT VIBRANT**

**Pavel Ioan^{*1)}; Chirita Alexandru Polifron¹⁾; Matache Gabriela¹⁾; Popescu Alina Iolanda¹⁾;
Pavel Kati¹⁾, Ștefan Vasilica²⁾**

¹⁾Hydraulics and Pneumatics Research Institute INOE 2000-IHP Bucharest, Romania

²⁾National Institute of Research – Development for Machines and Installations Designed
for Agriculture and Food Industry – INMA Bucharest

E-mail: pavel.ihp@fluidas.ro

DOI: <https://doi.org/10.356.33/inmateh-65-01>

Keywords: biomass, dryers, vibrating fluidized bed, vibrations

ABSTRACT

The article presents aspects related to energy potential of the shredded biomass from agricultural secondary production, coming from maintenance operations to cutting trees and vines and an original solution of dryer with vibrating fluidized bed with continuous operation equipped with adjustments of the transit time of biomass in the dryer. Also, it was analysed the dynamic behaviour of the biomass tray as well as of a biomass particle for the variant of vibrating fluidized bed.

ABSTRACT

Articolul prezinta aspecte legate de potentialul energetic al biomasei maruntite din productia secundara agricola, provenita din operatiile de intretinere la taierea pomilor si vitei de vie si o solutie originala de uscator cu pat fluidizat vibrant cu functionare continuua dotat cu reglaje ale timpului de tranzit al biomasei in uscator. De asemenea s-a analizat comportamentul dinamic al cuvei cu biomasa precum si al unei particule de biomasa pentru varianta de pat fluidizat vibrant.

INTRODUCTION

The cuttings in the orchards are made in the non-vegetative period and as a result the average humidity of the cut branches is 30-35%. If a humidity of 35% of a ton of cuttings is taken into account, by drying up to an average humidity of 15%, it results in 765 kg of biomass usable for the production of thermal energy that has an energy potential of 11.856 MJ or 3.3 MWhth. From a hectare of intensive orchards annually, on average, about 3 tons of biomass are cut, which have an energy potential of 35.628 GJ/ha·year.

The biomass from the cuttings is transported to the row end where it is chopped with specialized equipment at 10..50 mm and stored in containers with perforated walls for good air circulation, for natural drying, or for immediate use and dried in specialized installations. On average, the bulk density of the wet cut is 250 kg/m³, which leads to a need of about 12 containers for one hectare of orchard. By natural drying or in dryers, the biomass reaches an average humidity of 15% and a bulk density of about 200 kg/m³.

One ton of dry biomass has an energy potential of 15.530 GJ /t.bm or 4.3 MWhth. From the published data, for Europe, results an average cost of gathering, chopping and transport for a ton of cuts of about 40 €/t. Taking into account the costs for drying and a profit of 20%, it results that a ton of biomass usable for the production of thermal energy can be sold for about 80€/t. The specific price for the primary energy of biomass is in the case studied of 5.2 €/GJ or 18.6 €/MWhth, values much lower than those for diesel of 33.22 €/GJ or for LPG of 21.52 €/GJ (Pavel et al., 2020).

The researchers showed that for drying biomass from 30% to 15%, 70% of the energy consumed is used for processing, while for the actual pelleting of pellets - only 7%. Regarding the moisture of biomass for pelleting, Li, Yadong and Liu, Henry (Yadong and Henry, 2000), stated that it should be between 6-12%, and Obernberger, I. and Thek, G (Obernberger and Thek, 2004) recommend values of 8-12%. It should be noted that the moisture content of the raw material in the initial phase can far exceed the required level. Humidity after maintenance cuttings in orchards or vines is up to 50%. For economic reasons, reducing the high humidity of the harvested biomass is recommended to be achieved under natural conditions, using solar energy or atmospheric air (Ericsson and Werner, 2014; Iftekhhar et al., 2017).

The humidity of dry biomass under natural conditions depends very much on the humidity of the ambient air. At the ambient air temperature, $t_a = 25\text{ }^\circ\text{C}$ and its humidity, $\varphi_a = 85\%$ the wood can be dried in natural conditions up to a minimum humidity of 18% (Ivanov, 1956). Therefore, in order to obtain biomass in accordance with technological requirements, it must be further dried under artificial conditions.

Experimental research, performed jointly by researchers from Canada and the US (Rezaei et al., 2016), showed that the size, shape and density of biomass particles influence transportability and fluidization, drying rate and decomposition. Also the air temperature and the drying speed influence the uniformity of the deep drying of the biomass particle (Pazyuk et al., 2018).

There is a wide variety of artificial drying methods (Gavrilencov et al., 2014) and in specialized articles scientists study different types of dryers: with active ventilation (Gaponyuk et al., 2014), with infrared radiation with vibrating trays (Bandura et al., 2019), with electromagnetic vibrations (Burdo et al., 2017), with intermittent drying (Kumar et al., 2008), with convective drying (Ahrné et al., 2007), with microwave (Apolzan et al., 2020) or a combination of a convective method of heat supply with the introduction of ozone as a drying agent (Tsurkan et al., 2013). For the study of dynamic behaviour a new solution of dryer with vibrating fluidized bed with continuous workflow is presented, a solution for which a national patent application was submitted.

MATERIALS AND METHODS

CALCULATION OF THE TECHNOLOGICAL DRYING PROCESS

Drying is the operation by which water from solid materials (in our case biomass) is removed with the help of air which has the role of bringing the heat necessary to vaporize moisture and to evacuate the resulting water vapour. The speed of the drying process is defined by the amount of moisture removed from the surface unit of the material to be dried in the unit of time.

In the technological process of artificial drying (fig.1) wet biomass and dry air enter and dry biomass and wet air come out.

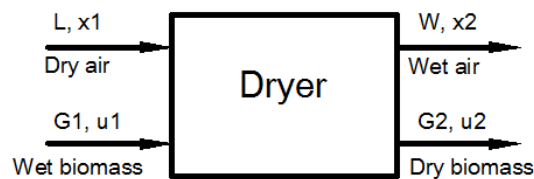

Fig. 1- Block diagram of the artificial drying process

x_1 - air humidity at the inlet [kg water / kg wet air]; x_2 - air humidity at outlet [kg water/kg wet air]; L - absolutely dry air flow [kg air/h]; G_1 - input biomass flow [kg /h]; G_2 - output biomass flow [kg /h]; u_1 - absolute humidity of the input biomass [kg water / kg wet biomass]; u_2 - absolute humidity of the output biomass [kg water/kg wet biomass]; W - the amount of water removed from the biomass [kg water/h]

The material balance of a dryer is as follows:

The general balance equation:

$$G_1 = G_2 + W \quad (1)$$

The biomass moisture balance equation:

$$G_1 \cdot u_1 = G_2 \cdot u_2 + W \quad (2)$$

The balance equation of absolutely dry biomass:

$$G_1 \cdot (1 - u_1) = G_2 \cdot (1 - u_2) \quad (3)$$

The amount of water removed from the biomass:

$$W = G_1 \times u_1 - G_2 \times u_2 = G_1 \times \left(u_1 - \frac{1 - u_1}{1 - u_2} \right) \quad (4)$$

The humidity balance equation in the dryer:

$$L \cdot x_1 + G_1 \cdot u_1 = L \cdot x_2 + G_2 \cdot u_2 \quad (5)$$

$$L \cdot (x_2 - x_1) = G_1 \cdot u_1 - G_2 \cdot u_2 = W \quad (6)$$

The air requirement:

$$L = \frac{W}{x_2 - x_1} \quad (7)$$

The specific air consumption:

$$I = \frac{L}{W} = \frac{1}{x_2 - x_1} \quad [\text{kg wet air /kg removed water}] \quad (8)$$

The speed of the drying process:

$$w = \frac{dW}{A \cdot dt} \quad (9)$$

where:

- w - speed of the drying process;
- dW - the amount of moisture removed;
- A - the unit of surface of the material subjected to drying;
- dt - unit of time.

The drying time:

When the drying speed is known, the drying time is determined by integrating the equation:

$$w = \frac{dW}{A \cdot dt} \Rightarrow t = \int \frac{dW}{A \cdot w} \quad (10)$$

The theoretically deduced equations for the drying speed are complicated and difficult to apply and the solution of the problem must be accompanied by experimental data at laboratory scale which are transposed at industrial scale.

NEW DRYER SOLUTION WITH VIBRATING FLUIDIZED BED AND CONTINUOUS OPERATION

The dryer solution shown in fig. 2 is with vibrating bed and self-feeding with biomass; it uses hot air or from atmosphere and allows adjustments for the transit time of biomass through the dryer, consequently adjustment of the biomass drying degree at the output of the dryer.

The dryer consists of an outer housing (3), inside which there is a vibrating tray (2) which rests on four springs (9) and is vibrated by the electric vibrating motor (11). The hot air enters through two pipes (15) which have three flaps (12) with which it adjusts the distribution of hot air on the six pairs of hole profiles (13) located on the bottom of the tray. The feeding flap is a common body with the vibrating tray and when their mass decreases due to the loss of water from the dry biomass, the springs (9) lift the vibrating assembly and initiate the self-feeding with biomass from the feeding tray (8).

When the weight of the tray increases due to re-feeding, it presses the springs and with it moves the feeding flap that closes the feeding orifice. The advance speed of the biomass in the dryer is made by adjusting the angle (a) of the baffles (14), by adjusting the angle (b) of the working position of the vibrating tray and by adjusting the amplitude (eccentricity against weights), frequency (electric motor rotational speed) and the direction of rotation of the vibrating motor.

The outer housing stands on four legs and consists of a biomass feeding tray (8), a humid air exhaust chimney (7) and an inspection hole (4).

The feeding of the tray with biomass is done in self-feeding regime. The feeding flap (6) is fixed to the vibrating tray and moves with it. When the biomass to be dried loses between 10-65% water by evaporation, due to weight loss, the springs (9) lift the vibrating tray and with it the feeding flap that allows the biomass to fall from the feeding tray (8) into the vibrating tray (2) for re-feeding. For example, for the conditions imposed during the simulation, when reducing the weight from 50 kg to 30 kg (approx. 65%), the vertical displacement of the vibrating tray is approx. 20 mm (fig. 11).

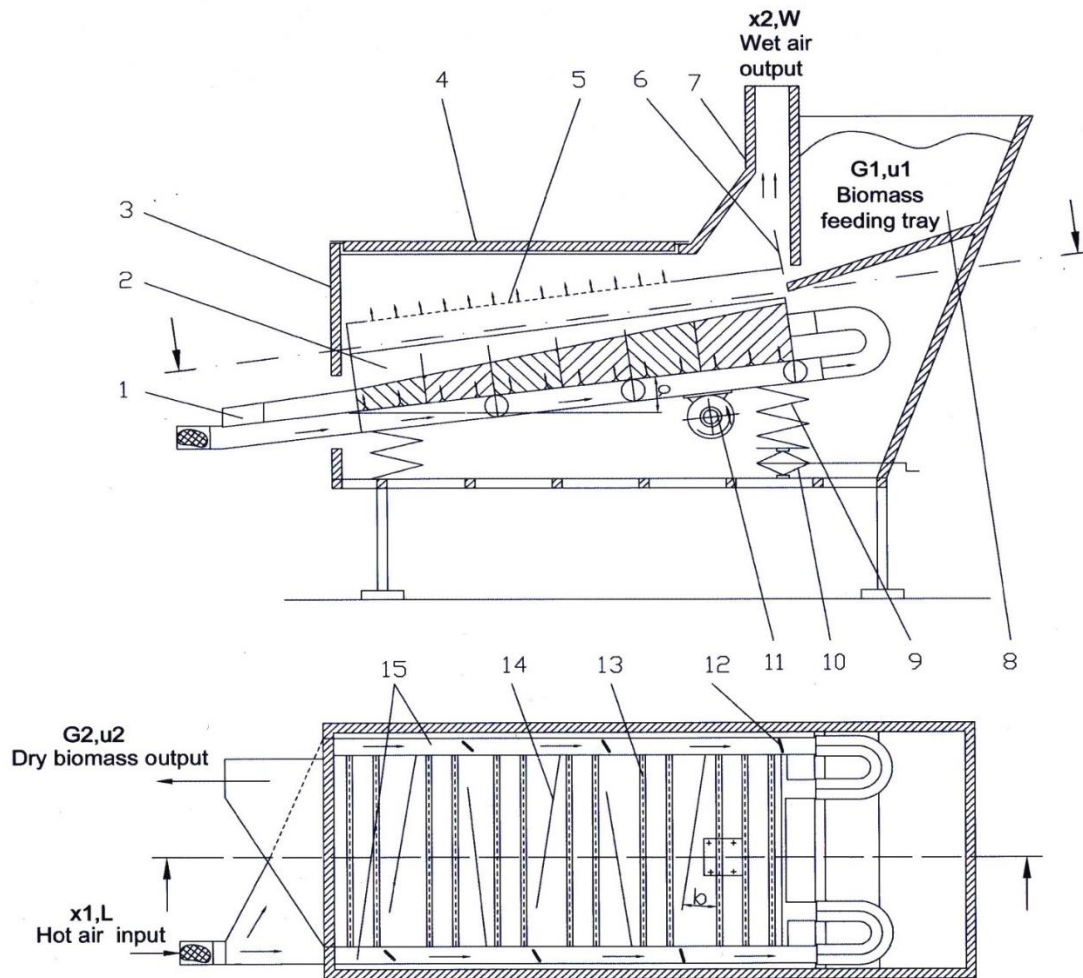

Fig. 2 - Principle drawing of the dryer with vibrating fluidized bed for shredded biomass

1- dry biomass output; 2-vibrating tray; 3- outer housing; 4-inspection hole; 5- filter; 6-feeding flap; 7- humid air exhaust chimney; 8- feeding tray with biomass; 9-spring; 10- jack for adjustment of the working angle; 11- industrial vibrator with electric motor; 12- hot air dose adjustment flaps; 13- L profile with holes; 14-baffle; 15- hot air supply pipes; x_1 - air humidity at the inlet; x_2 - air humidity at outlet; G_1 - input biomass flow; G_2 - output biomass flow; u_1 - absolute humidity of the input biomass; u_2 - absolute humidity of the output biomass; L - absolutely dry air flow; W - the amount of water removed from the biomass

Uniform distribution of air flow inside the drying tray is very important because it determines both the drying efficiency and the homogeneity of the products that are dried (Amanlou et al., 2010). Thus, on the sides of the vibrating tray are placed two hot air supply pipes (15) in which are installed three adjustment flaps (12) for dosing the hot air through the holes profiles (13) over which the biomass to be dried moves. The surplus of hot air is directed to the wettest area, to the biomass freshly introduced in the dryer.

The humidity of the biomass at the output of the dryer (1) depends on the granulation of the biomass, on the humidity of the raw material, on the flow and temperature of the hot air introduced in the pipes (15) and on the transit time of the dryer. The latter can be adjusted by changing the angle (b) of the baffles (14) or by changing the relief angle of the vibrating tray (a) using the jack (10). The arrow of the springs (9) is calculated for the weight of the vibrating tray loaded with biomass and for the size of the desired feeding orifice. Also, the amplitude, frequency (rotational speed) and direction of vibrations produced by the vibrator with electric motor influence the transit time of the biomass in the dryer. When the humidity of the biomass at the output of the dryer is the desired one if the adjustments made are maintained and the introduced biomass is approximately of the same humidity, the dryer feeds itself and works continuously.

SIMULATION

The following will present a numerical simulation performed with a proprietary 2D multibody dynamics software (Liu et al., 2016), developed in the institute, which analyses only the mechanical aspects of the dryer, the results were plotted with the help of the Amesim software facilities and the physical model was made in

AutoCAD in order to be able to enter the precise coordinates in the calculation. The role of the simulation is to validate the new dryer concept and to see the influence that certain parameters have on the process of displacement of a biomass particle on the dryer tray.

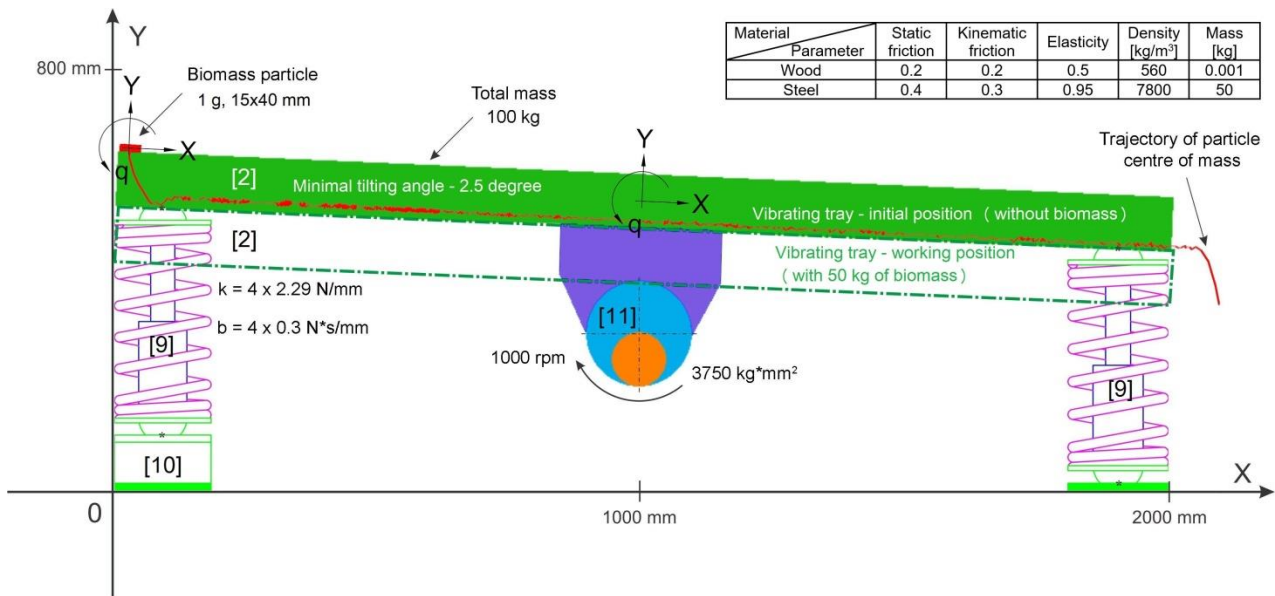

Fig. 3- Physical simulation model of the dryer

[2] - vibrating tray; [9] – springs and dampers; [10] - jack for adjustment of the working angle; [11] - industrial vibrator with electric motor

Figure 3 shows the physical model of the numerical simulation, it consists of:

- the vibrating tray [2], it has an initial mass of 50 kg, when not loaded, and when the dryer is loaded to its maximum capacity, it supports a maximum load of 50 kg of biomass, in total 100 kg ;
- the 4 springs with dampers, that have the role of stabilizing the vibrations of the tray, have the following parameters: $k = 2.29 \text{ N/mm}$ and $b = 0.3 \text{ N*s/mm}$;
- the industrial vibrator with electric motor which has a speed of 1000 rev/min and moment of inertia of the eccentric of 3750 kg*mm^2 ;
- the biomass particle with dimensions of 15x40 mm and mass of one gram (see figure 4).

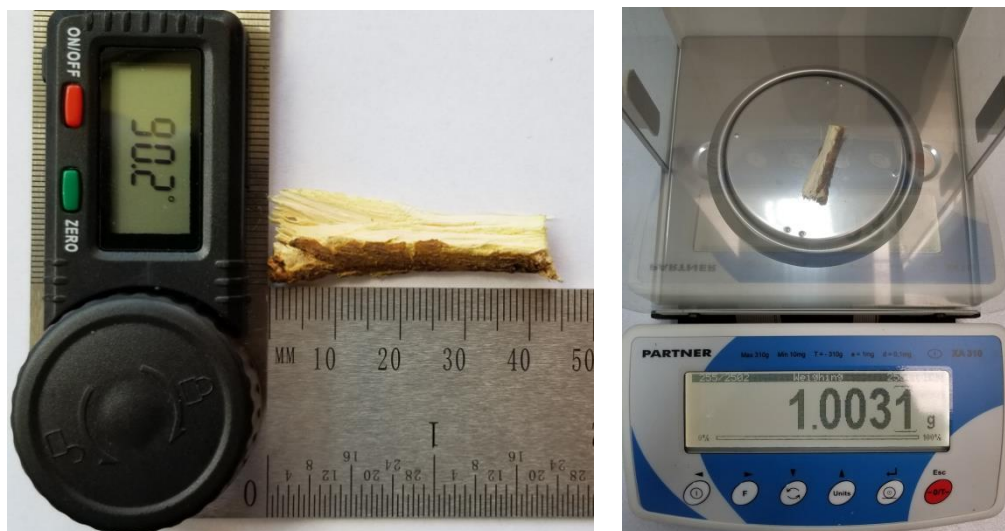

Fig. 4 - Biomass particle dimensions and mass

RESULTS

A new solution of dryer with vibrating fluidized bed, with continuous operation and multiple adjustments for the transit time of the biomass in the dryer and an algorithm for calculating the material balance, speed and drying time was presented (equations (1-10)). During the simulation, the dynamic behaviour of a 1 gram

biomass particle was analysed and its amplitude, shape and duration of displacement over a length of 2 ml were determined.

Numerical simulation results: The study performed with the help of numerical simulation presents the analysis of the dynamic behaviour of the dryer tray and the biomass particle.

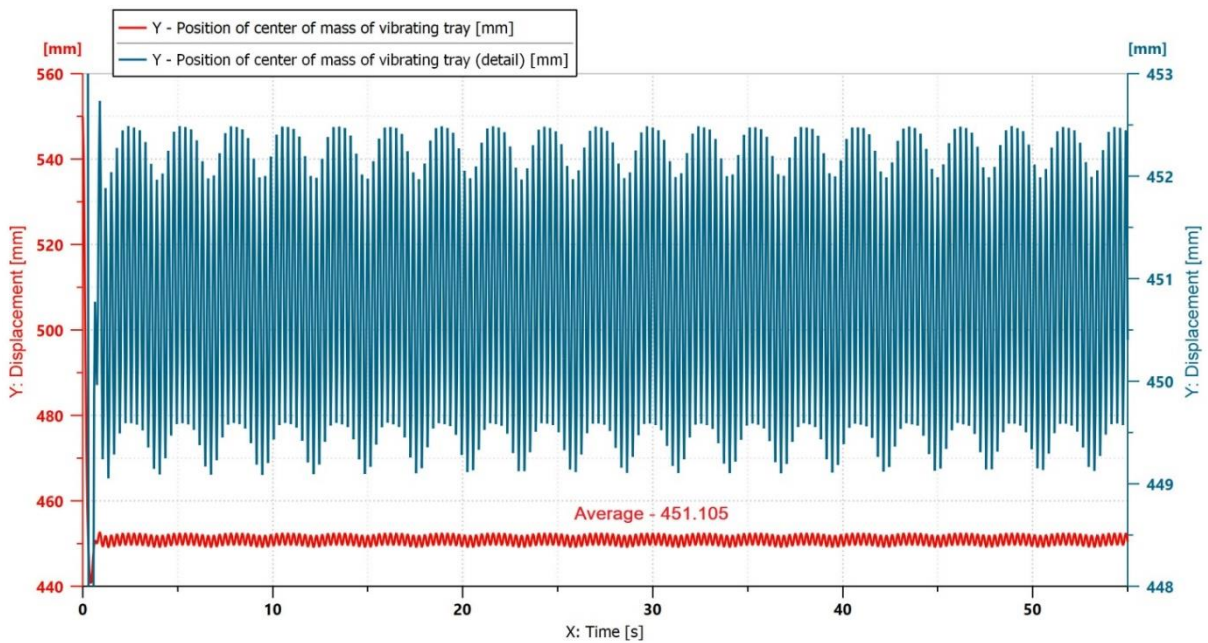

Fig. 5 - Y - Position of centre of vibrating tray mass (red) and in detail (blue)

Figure 5 shows the variation in time of the displacement on the Y-axis of the centre of gravity of the vibrating tray. In the graph, you can see how when the tray is loaded with the maximum amount of biomass, it goes down about 100 mm (550 mm to 451.1 mm); this displacement closes the biomass-feeding flap of the dryer. In the detail on the same figure, it can be seen that the amplitude of the vibration is about 3 mm.

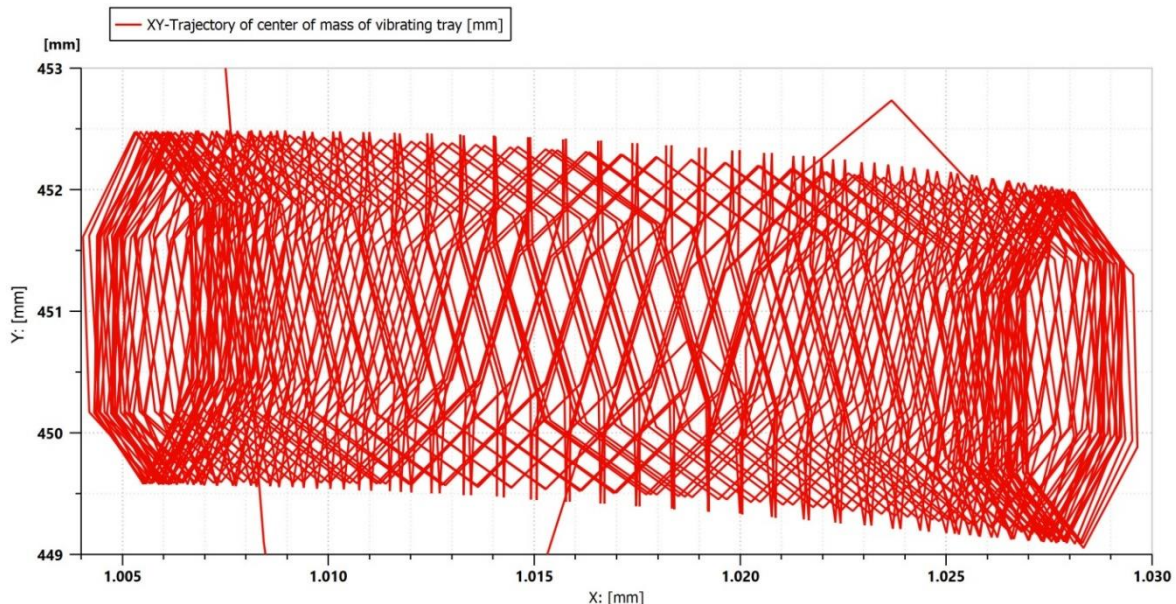

Fig. 6 - XY-Trajectory of centre of vibrating tray mass

Figure 6 shows the variation in time of the trajectory of the centre of mass of the tray; it can be observed that for a certain cycle the amplitude of the movement on the Y-axis has the value of 3 mm. On the X-axis the vibrating tray during operation moves a total of 26 mm; this movement does not affect the physical process of fluidization of particles.

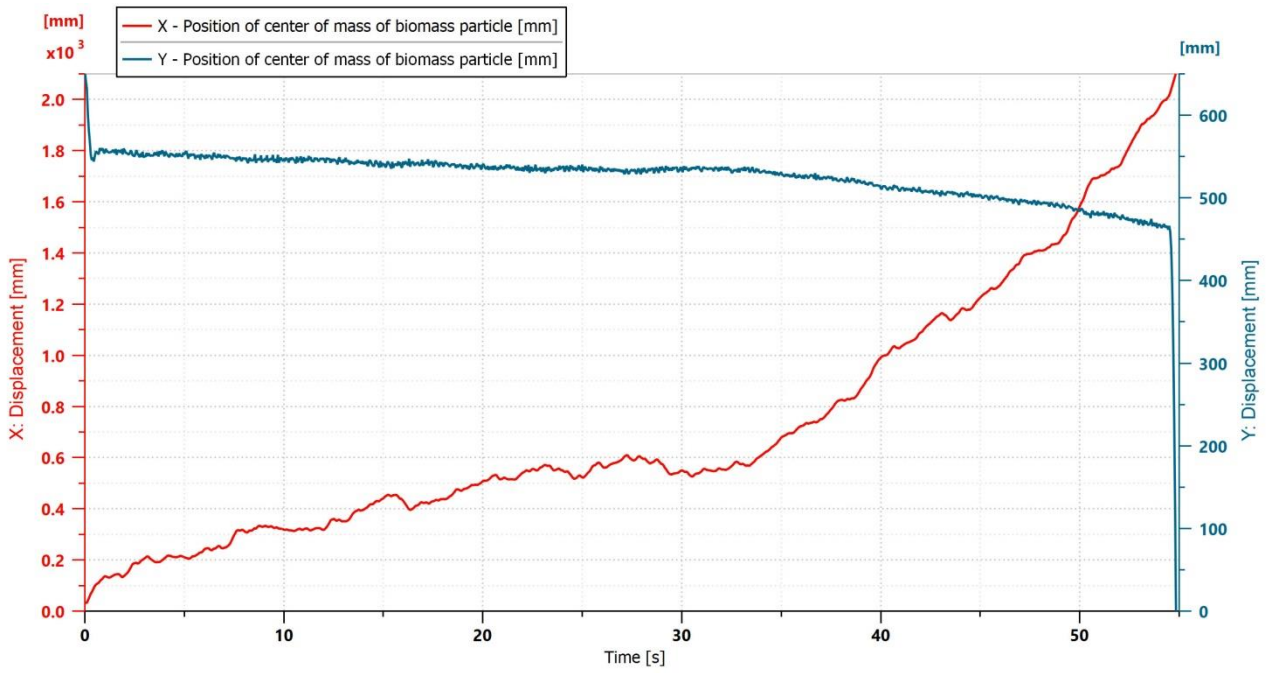

Fig. 7- Position on X&Y - axis of centre of biomass particle mass

Figure 7 shows the time variation of the displacement of the centre of gravity of the biomass particle on the X - axis with red colour and with blue colour on the Y - axis.

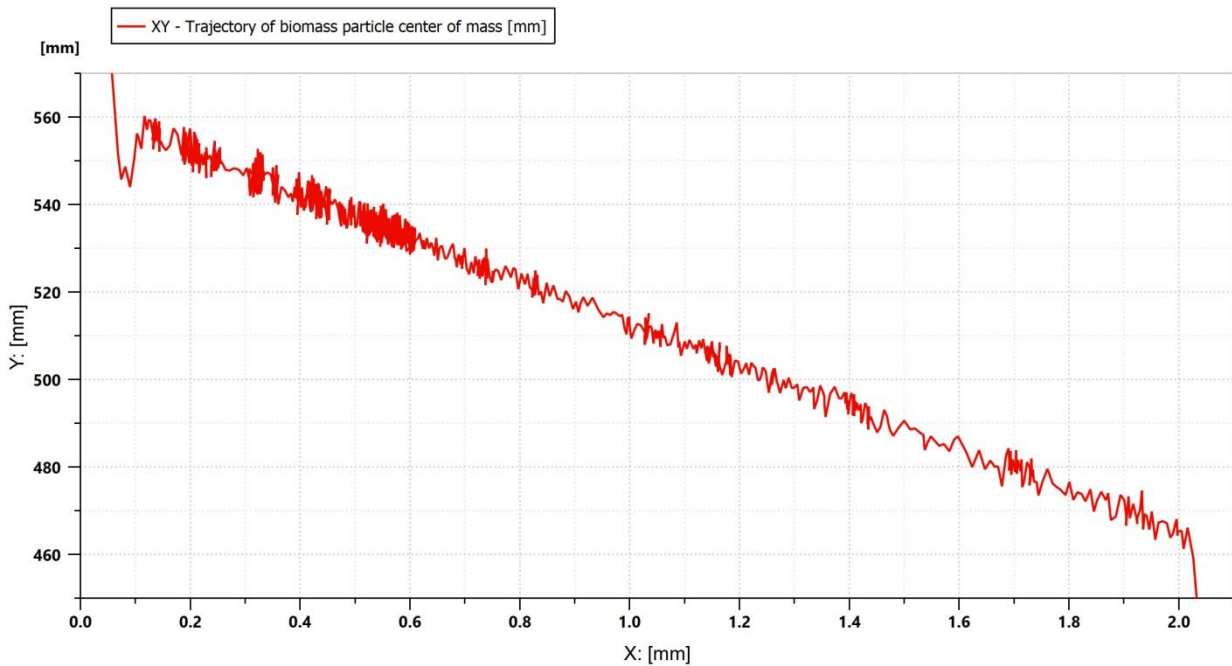

Fig. 8 - XY-Trajectory of centre of biomass particle mass

The time variation of the trajectory of centre of the biomass particle mass is shown in figure 8.

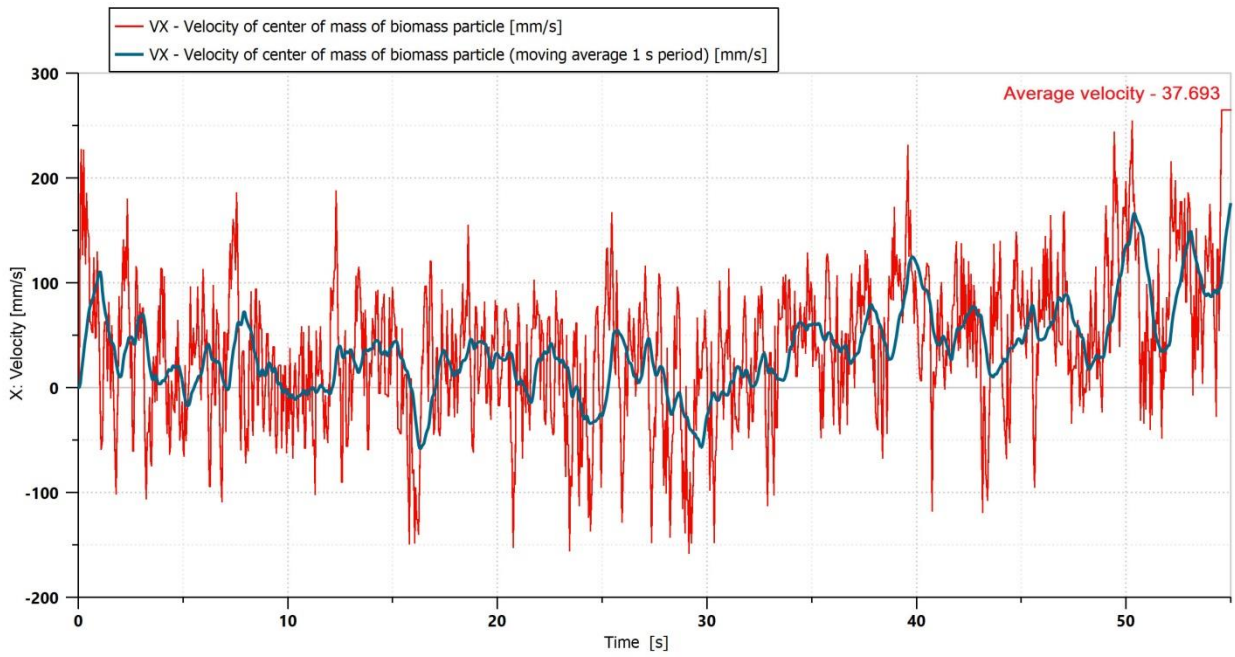

Fig. 9 - VX - Velocity of centre of biomass particle mass

The linear displacement velocity on the x-axis of the biomass particle is shown in Figure 9. It can be seen that for the angle of -2.5 degrees, the average linear velocity of the particle is about 37 mm/s. Also in the same figure, you can see the behaviour of the particle, the linear velocity of the particle is both positive and negative because the angle of inclination is small.

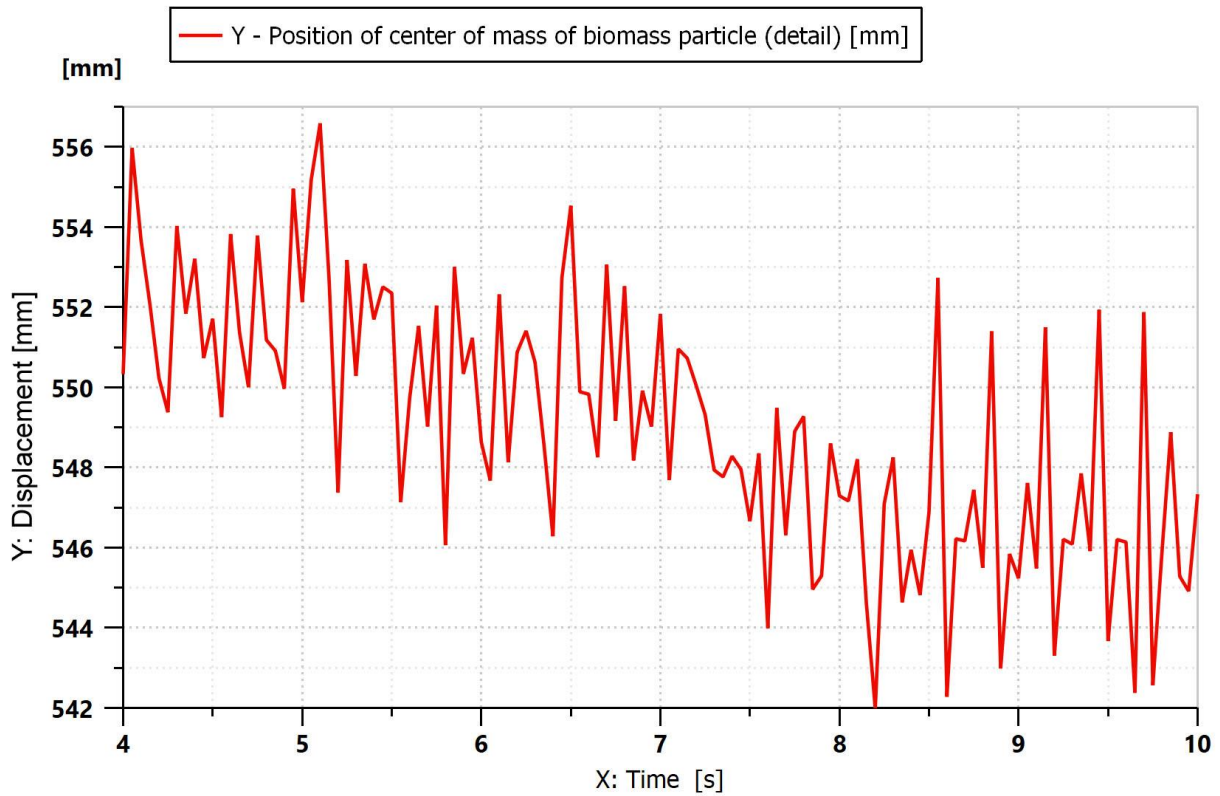

Fig. 10 - Y - Position of centre of biomass particle mass (detail)

On the detail presented in figure 10, it can be observed that the amplitude of the particle vibration varies between 2 and 11 mm. On average it has the value of 6 mm and the frequency of the particle vibrations has the average value of 8 Hz.

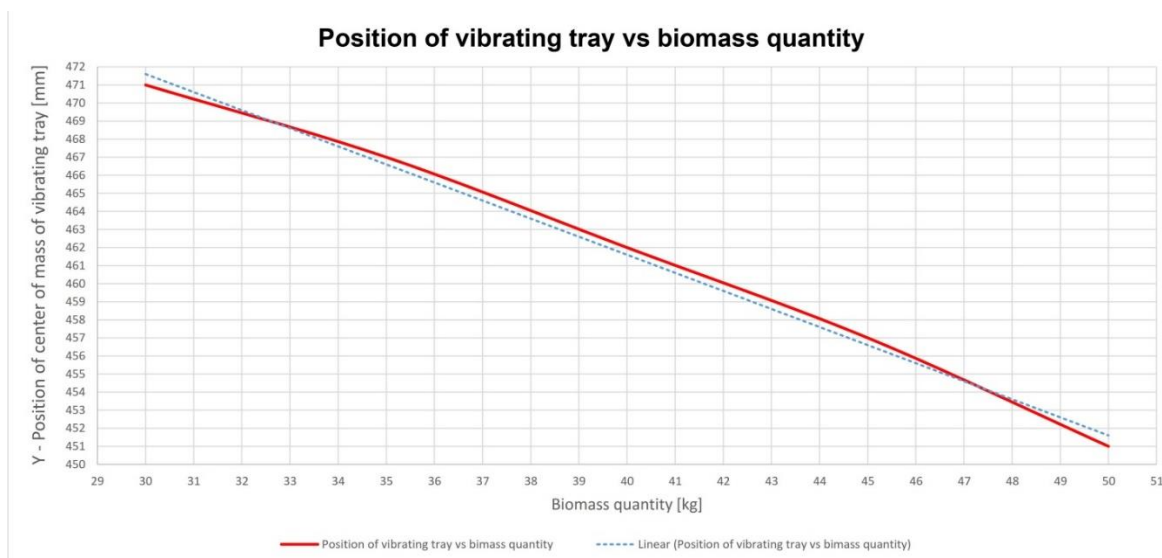

Fig.11 - Position of vibrating tray vs biomass quantity

CONCLUSIONS

The article presents a new dryer solution with vibrating fluidized bed that aerates the shredded biomass by controlled vibrations to increase the contact surface of the particles with the hot air in order to speed up the drying. The presented solution allows adjustments of frequency and amplitude, of working angle, of loading capacity at the vibrating tray obtaining a drying speed in relation to the followed humidity rate. It also allows the adjustment of the amount of hot air in different areas of the vibrating tray. The humid hot air is filtered through a sieve that self-shakes by vibration with the tray and before leaving the dryer preheats the biomass in the feed tray.

The simulation was done in order to study the motion of a biomass particle to estimate the transit time of wood chips in a dryer with vibrating tray. The study of dynamic behaviour mainly refers to the movement of a biomass particle of a rectangular shape weighing 1 gram. For the inclination angle of -2.5 degrees, the average frequency of 8 Hz and the average vibration amplitude of 6 mm, the average speed of the particle displacement was 37 mm / sec.

The implementation of the presented solution can bring energy savings because it does not impose conditions for the air temperature at the inlet, having multiple possibilities for adjusting the drying speed to achieve the humidity conditions of the biomass at the exit of the dryer. It is of simple construction, works continuously and does not require an operator for refeed. It consists of standardized elements (electric vibrating motor, springs) and a metal construction easy to make in any size for different productivity.

The presented dryer can be part of a biomass technological processing line whose final purpose is to obtain pellets, briquettes or shredded, dry biomass, for use in direct combustion in thermal boilers for hot water, electricity or hot air.

ACKNOWLEDGMENTS

This paper has been funded by the Romanian Ministry of Research and Innovation under NUCLEU Programme, Financial Agreement no. 18N/2019, Ad 13/14.04.2021, Project code PN 19-18.01.01, Theme 1, Phase "Advanced research on the development of an optimized heat generator solution, based on the TLUD principle". This paper has been developed, as part of a project co-financed by the European Union through the European Regional Development Fund, under Competitiveness Operational Programme 2014 - 2020, Priority Axis 1: Research, technological development and innovation (RD&I) to support economic competitiveness and business development, Action 1.2.3 – Partnerships for knowledge transfer, project title: Eco-innovative technologies for recovery of biomass wastes, project acronym: ECOVALDES, SMIS code: 105693-594, Financial agreement no. 129/23.09.2016.

REFERENCES

- [1] Ahmné L. M., Pereira N.R., Staack N., Floberg P., (2007), Microwave Convective Drying of Plant Foods at Constant and Variable Microwave Power, *Drying Technology*, vol. 25 (7-8), London/UK, pp. 1149-1153;
- [2] Amanlou Y., Zomorodian A., (2010), Applying CFD for designing a new fruit cabinet dryer, *Journal of Food Engineering*, vol. 101, (1), pp. 8-15;
- [3] Apolzan R, Perebiceanu A., Mateias F., (2020), Microwave Drying of Biomass, *Hidraulica Magazine*, no.3, ISSN 1453-7303, pp. 33-43;
- [4] Bandura V., Mazur V., Yaroshenko L., Rubanenko O., (2019) Research on sunflower seeds drying process in a monolayer tray vibration dryer based on infrared radiation, *INMATEH – Agricultural Engineering*, vol. 57, no.1, Bucharest/Romania, pp. 233-242;
- [5] Burdo O., Bandura V., Zykov A., Zozulyak I., Levtrinskaya J., Marenchenko E., (2017), Development of wave technologies to intensify heat and mass transfer processes, *Eastern European Journal of Advanced Technology*, vol. 4, no.11(88), Kharkiv/Ukraine, pp. 14-18;
- [6] Ericsson K., Werner S., (2014), The introduction and expansion of biomass use in Swedish district heating systems, *Biomass Bioenergy*, vol. 94, pp. 57-65;
- [7] Gaponyuk O.I., Ostapchuk M.V, Stankevich G.M., (2014), *Active ventilation and grain drying (Активне вентилявання та сушіння зерна)*, Polygrap Publishing House, Odessa/Ukraine p. 325;
- [8] Gavrilencov A.M. et al., (2014), *Methods of substantiation of the choice of drying method and type of drying units for agro-industrial complex (CAI) (Методика обоснования выбора способа сушки и типа сушильных установок для АПК)*;
- [9] Iftekhhar C.M., Norton H.B., Duffy A., (2017), Technological assessment of different solar-biomass systems for hybrid power generation in Europe, *Renewable and Sustainable Energy Reviews*, vol.68, pp. 1115–1129;
- [10] Ivanov V.F., (1956), *Wooden constructions (Деревянные конструкции)*. Literature for constructions and architecture, Leningrad-Moscow / Russia, p. 254;
- [11] Kumar C., Karim M. A., & Joardder M. U. H. (2014). Intermittent drying of food products: a critical review. *Journal of Food Engineering*, vol. 121, “Elsevier” Publishing House, Amsterdam / Netherlands, ISSN: 0260-8774, pp 48-57;
- [12] Li Y., Henry L., (2000), High-pressure densification of wood residues to form an upgraded fuel, *Biomass and Bioenergy*, vol. 19, ISSN: 0961-9534, pp. 177-186;
- [13] Liu J., Ji J., Zhou J., (2016), Synchronization of networked multibody systems using fundamental equation of mechanics, *Applied Mathematics and Mechanics (English Edition)*, vol. 37 (5), Shanghai University and Springer-Verlag Berlin Heidelberg, DOI 10.1007/s10483-016-2071-8, pp. 555–572;
- [14] Obernberger I., Thek G., (2004), Physical characterization and chemical composition of densified biomass fuels with regard to their combustion behaviour, *Biomass and Bioenergy*, vol. 27, ISSN: 0961-9534, pp. 653-669;
- [15] Pavel I., Matache G., Chiriță Al. P., Popescu, A.I., Diaconu C., (2020), Biomass Processing from Agricultural Residual Production and Maintenance Operations when Cutting Trees and Vines. *Hidraulica Magazine* no. 4 ISSN 1453-7303, pp. 93-97;
- [16] Pazyuk V., Petrova Zn., Chepeliuk O., (2018), Determination of rational modes of pumpkin seeds drying. *Ukrainian Food Journal*. vol. 7, Issue 1, Kyiv/Ukraine, pp. 135-150;
- [17] Rezaei H., Lima C. J., Lau, A. et al., (2016), Size, shape and flow characterization of ground wood chip and ground wood pellet particles, *Powder Technology*, vol. 301, “Elsevier “Publishing House, pp. 737–746;
- [18] Tsurkan O.V., Necheporenko S.A., Blyznyuk M. Ya., (2013), Modern methods of drying grain materials (Сучасні способи сушіння зернових матеріалів), *Vibratsiyi v tekhnitsi ta tekhnolohiyakh*. no.1, Vinnytsia/Ukraine, pp. 130-134.