

## MODEL PREDICTIVE CONTROL OF ACTIVE POWER AND REACTIVE POWER CONTROL IN THREE PHASE GRID CONNECTED INVERTER

P. Siva Krishna<sup>1</sup> & K.S.S Prasad Raju<sup>2</sup>

<sup>1</sup>Research Scholar, S.R.K.R. Engineering College, Bhimavaram, Andhra Pradesh, India

<sup>2</sup>Assistant Professor, Department of EEE, S.R.K.R. Engineering College, Bhimavaram, Andhra Pradesh, India

### ABSTRACT

The concept of this paper is to control the active power and reactive power for three-phase grid-connected inverters. Here, we have proposed that the control strategy of Model Predictive Control (MPC) be used instead of pi controllers. Comparing with traditional current control methods, a linear model of the load is needed to adjust the pi controllers. In the case of MPC, it will calculate predictions for each voltage vector, a discrete model of the load that does not need to be linear. The performance of the pi controllers depends on the  $k_p$ ,  $k_i$  values, and their adjustments. There are no parameters to adjust in MPC, but the cost function must be defined. And the proposed method MPC has a better dynamic performance, and it will give transient dynamics recovery time and overshoot will have been considerably improved. Conclusively, the simulation results are allowed to confirm the efficiency of the proposal.

**KEYWORDS:** Model Predictive Control

---

### Article History

**Received: 14 Oct 2020 | Revised: 19 Oct 2020 | Accepted: 16 Nov 2020**

---

### INTRODUCTION

Control system engineering is the discipline that applies control theory to design systems with the desired behaviour. And these activities focus on the implementation of control systems mainly derived from mathematical modelling of systems. Many control systems are used today in a large number of industrial applications. There are a lot of control strategies such as adaptive control, intelligent control, optimal control, robust control model predictive control (MPC), and stochastic control. Model predictive control method is the latest and innovative process. From the past few years it has been used in balancing model of the power systems. Comparing with PID controllers the predictive capability is more in MPC. This model can expect the future events according to the control actions. Predictive control is a large range of controllers, and it is used to control the power converters because of the better dynamic performance. MPC needs more calculations and it is more complex than classic controllers like PI, PID. The reason behind the realization of predictive control is the fast microprocessors. The best part of the model predictive control is afterward response of the control variables. The important thing is optimization criterion, that is, the reference to optimal actuation. We have seen the programs are presented in the name of model predictive control. They are the classifications of the MPC. MPC is having the finite control set, and it does

not need modulator to generate the necessary voltage. The classic controllers are generates the signals directly for the converter without modulator under a variable switching frequency.

## PI CONTROLLERS

Pi means proportional integral controller. this mode results from the combination of the proportional and the integrate mode, certain advantages of both control actions can be obtained from this mode is also called as the proportional plus reset action controller equations for the proportional mode and integral mode are combined to have an analytic expression for this mode which is given below.

$$P = k_p e_p + k_p k_t \int e_p dt + p_{t(0)}$$

Where  $p_{t(0)}$  is the integral term value at  $t=0$  (initial value)

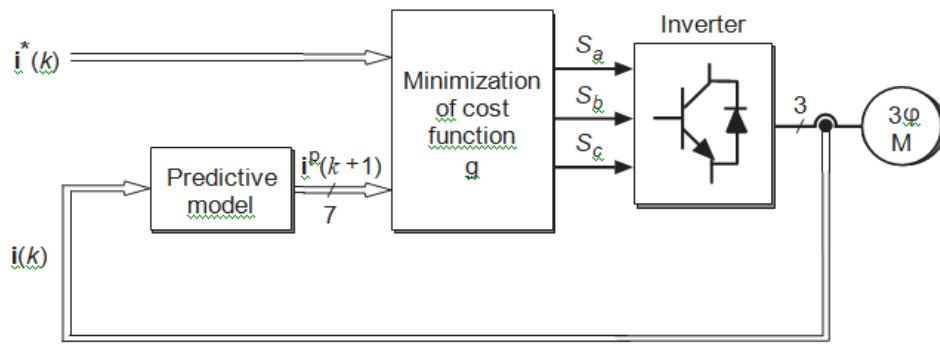
Actually the stator current errors are controlled using pi controllers which generate the stator reference frame voltage  $v_{sd}^*, v_{gd}^*$  then, these voltages are converted to the stationary reference frame and applied to the inverter using a pulse width modulator. The dynamic response of using pi controller with PWM little bit slow due to the decoupling capability of current control loop and dynamics of the closed loop current loops. In pi controller the controlling adjustments are mostly depends on the value of  $k_p, k_i$  mathematical expressions to find the values of  $k_p, k_i$  are sometimes going to be complex for the proposed model  $k_p, k_i$  and the result of pi controller given to the PWM, and then inverter the proportional integral (pi) controller is used to decrease the steady state error without effecting the stability of the control system.

## MODEL PREDICTIVE CONTROL

Here the proposed model MPC is to control both P and Q for three three-phase inverter. And it is one of the most likely control methods, especially for power converters. Why because it is so effective and prime. Model predictive control is all about to minimize the cost function by predicting the next step is being optimal control and it is under control within the obstacles. The consequences of the operation may give the best results and flexibility in the system results by remodelling the parameters. This feature is so good when exercise conditions varies consistently

### Predictive Current Control

In the proposed model switching states are very important and plays key role. This is because each and every switching state is recorded and implemented. From those states we have to predict the value and execute the programme. At last the results we have taken and observed. Switching states are limited and calculated, because it is under control. Here the cost function is so important and we need to minimize for that we need to put a criteria to achieve, and it is having the predicted values to be obtained then the variables are changed as we expected. So that the costs function minimize and then selected.



**Figure 1: Predictive Current Control Block Diagram.**

**Cost Function**

The aim of control scheme is to depreciate the error between the actual currents and the reference values. This limitation can be appearing as cost function. The cost function is expressed in rectangular coordinates and finding the error between the references and the predicted currents:

$$g = |i_{\alpha}^*(k + 1) - i_{\alpha}^p(k + 1)| + |i_{\beta}^*(k + 1) - i_{\beta}^p(k + 1)| \tag{1}$$

Where  $i_{\alpha}^*(k + 1)$  is the real part of the reference current vector  $i^*(k+1)$ ,  $i_{\alpha}^p(k + 1)$  is real part of the predicted load current vector  $i^p(k + 1)$ ,  $i_{\beta}^*(k + 1)$  is unreal part of the reference current vector  $i^*(k + 1)$ .  $i_{\beta}^p(k + 1)$  is the unreal part of the predicted load current vector  $i^p(k + 1)$ .

**Modelling of the Current Control Loop**

In this context the discussion about the current controlled loop is absolutely obtained or modelling by using Kirchhoff laws. Why because it is a closed loop control system. Here we need to regulate the converter output current by producing precise output voltage reference. According to the current law, output current is in the reference frame of the inverter.

In which  $l$  - Inductance,  $R$  -Resistance of the filter,  $v_1$  -converter output voltage,  $I$  -the current injected to the load,  $v$  -the load voltage.

$$L \frac{di}{dt} + ri = v_1 - v \tag{2}$$

Similarly the three phase system can be expressed as

$$\begin{aligned} L \frac{di_a}{dt} + Ri_a &= v_{a1} - v_a \\ L \frac{di_b}{dt} + Ri_b &= v_{b1} - v_b \\ L \frac{di_c}{dt} + Ri_c &= v_{c1} - v_c \end{aligned} \tag{3}$$

Applying reference frame transformation to the above equations

$$L \frac{di_d}{dt} + Ri_d - \omega Li_q = v_{d1} - v_d \tag{4}$$

$$L \frac{di_q}{dt} + Ri_q - \omega Li_d = v_{q1} - v_q \tag{5}$$

$i_d, i_q$  are the currents injected to the load on the d reference frame.

$$v_{d1}^* = v_{d1} + \omega L i_q - v_d \tag{6}$$

$$v_{q1}^* = v_{q1} - \omega L i_d - v_q \tag{7}$$

$v_{d1}, v_{q1}$  are the converter output voltages on the d axis.

$v_d, v_q$  are the load voltages

$\omega$  is the frequency

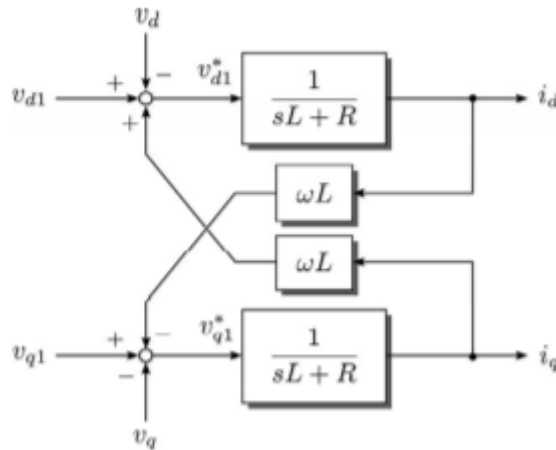
The output voltage reference are modified by means of adding on decoupling term and one feed forward voltage as

The current control loop model after the modification that can be written as

$$L \frac{di_d}{dt} + R i_d = v_{d1}^* \tag{8}$$

$$L \frac{di_q}{dt} + R i_q = v_{q1}^* \tag{9}$$

in which the d-q axis output currents are decoupled fig. shown below



**Figure 2: Block Diagram Representation of the c Side System of Three Phase dc/ac Inverters in the dq Reference Frame.**

According to the plant transfer functions from the converter output voltage references to the output current can be obtained as

$$\frac{i_d(s)}{v_{d1}^*(s)} = \frac{i_q(s)}{v_{q1}^*(s)} = \frac{1}{sL + R} \tag{10}$$

**Modeling of PQ Control Loop**

In the synchronous d reference frame the instantaneous active power and reactive power can be calculated as

$$P = \frac{3}{2} (v_d i_d + v_q i_q) \tag{11}$$

$$Q = \frac{3}{2} (v_q i_d - v_d i_q) \tag{12}$$

Assuming the phase locked loop (PLL) is assigned with the load voltage vector to the d- axis of the d-q reference frame ( $v=0$ ). The transfer function from the d-q axis and the d-q axis output currents to the active and reactive power can be calculated as

$$\frac{P(s)}{i_d(s)} = \frac{3}{2}v_d(s) = \frac{3}{2}v_m \tag{13}$$

$$\frac{Q(s)}{i_q(s)} = -\frac{3}{2}v_d(s) = -\frac{3}{2}v_m \tag{14}$$

Switching states and their voltage vectors are represented in the table, switching states are considering as eight expected combinations of the gating signals  $S_a, S_b, S_c$ . And further eight voltage vectors also obtained, then the result shown in fig.3 of complex plane of the voltage vectors found seven mismatched vectors appeared. From the table we can observe that  $V_0 = V_7$ .

Table: Switching states and Voltage vectors

$S_a$	$S_b$	$S_c$	Voltage vector V
0	0	0	$V_0 = 0$
1	0	0	$V_1 = \frac{2}{3}V_{dc}$
1	1	0	$V_2 = \frac{1}{3}V_{dc} + j\frac{\sqrt{3}}{3}V_{dc}$
0	1	0	$V_3 = -\frac{1}{3}V_{dc} + j\frac{\sqrt{3}}{3}V_{dc}$
0	1	1	$V_4 = -\frac{2}{3}V_{dc}$
0	0	1	$V_5 = -\frac{1}{3}V_{dc} - j\frac{\sqrt{3}}{3}V_{dc}$
1	0	1	$V_6 = \frac{1}{3}V_{dc} - j\frac{\sqrt{3}}{3}V_{dc}$
1	1	1	$V_7 = 0$

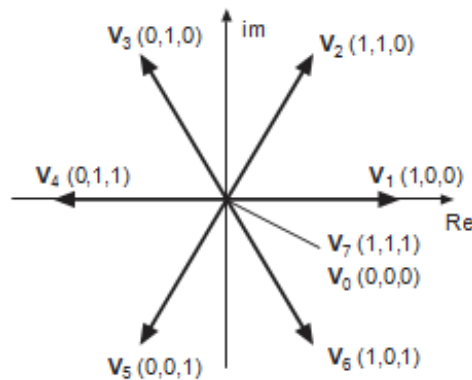


Figure 3: Voltage Vectors in the Complex Plane.

**Discrete Time Model for Prediction**

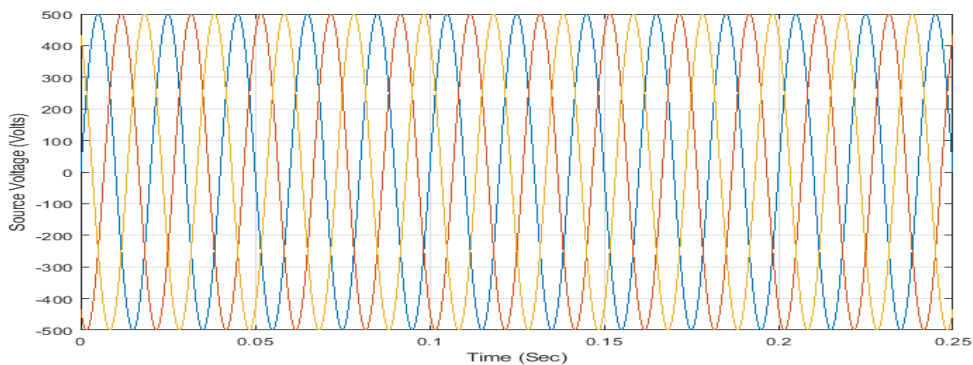
The discrete-time model will be used to predict the future value of load current from the voltages and measured currents at the  $k^{th}$  sampling instant. Several discrete methods can be used to obtain a discrete-time model suitable for the calculation of predictions. Considering that the load can be modelled as first-order system the discrete-time model can be obtained by a simple approximation of the derivative. However, for the more complex systems this approximation may introduce errors

into the model and a more accurate discrete method is required. The load current derivative  $\frac{di}{dt}$  is replaced by a forward Euler approximation. The derivative is approximated as follows:

$$\frac{di}{dt} \approx \frac{i(k+1)-i(k)}{T_s} \tag{15}$$

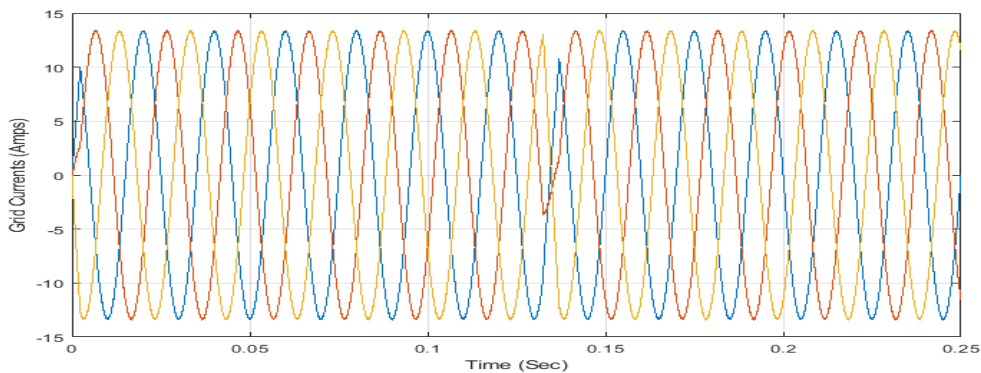
**SIMULATION RESULTS**

The experiment results are given by the MATLAB software. The simulation results consist of the supply voltage and grid currents concerning time. Here the time represents the simulation time  $t=0.25\text{sec}$ . in this paper, we have to control the active and reactive power for three-phase grid-connected inverter by using the proposed method of model predictive control (MPC). The constant dc output voltage is given to the input of inverter by the dc-link capacitor. The dc voltage is 500V shown in the fig: 4.1 below.



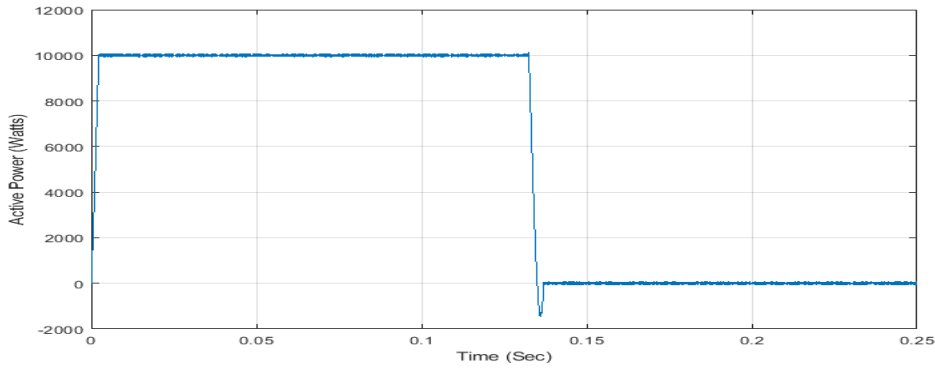
**Figure 4.1: The Inverter Output Voltages are Connected to the Grid as the Supply Voltage  $V_a, V_b, V_c$ .**

There we can observe the absence of the disturbance from the source voltage waveform.



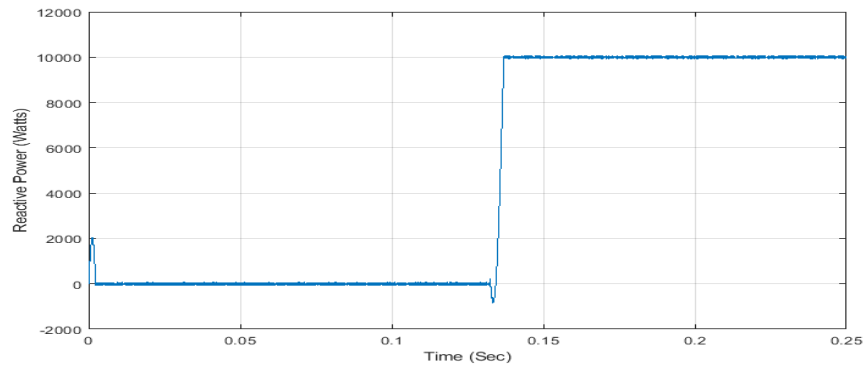
**Figure 4.2: The Grid Currents (amps) w.r.t. Time (sec)  $i_a, i_b, i_c$**

If we can observe the grid currents waveform above fig: 4.2 at the time of 0.135 sec the currents are not in natural, there the current has been varied for some time. The magnitude of grid currents is 13.5amps approximately.



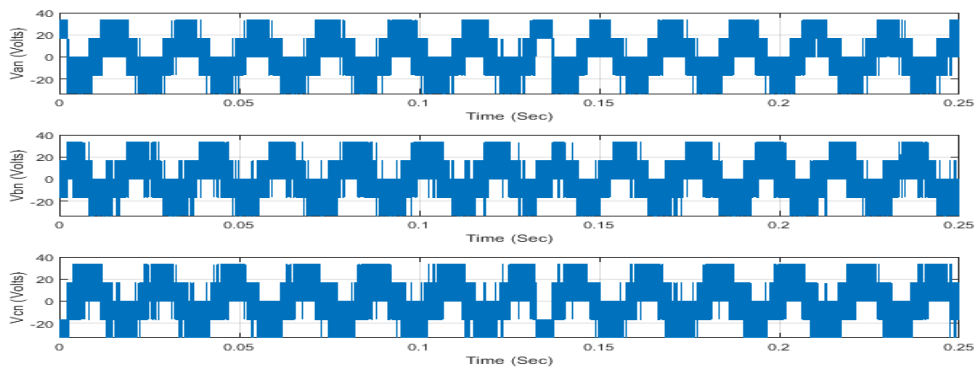
**Figure 4.3: Active Power (w) w.r.t Time (sec).**

The purpose of the inverter is to convert DC to AC. The positive signal in the waveform represents the generation of active power and the negative signal in the waveform producing the reactive power from the fig 4.1 and fig 4.2. The active power produced by the proposed control method is 10000 W. There the result we have shown in fig: 4.3 the active power w.r.t time up to 0.135sec.

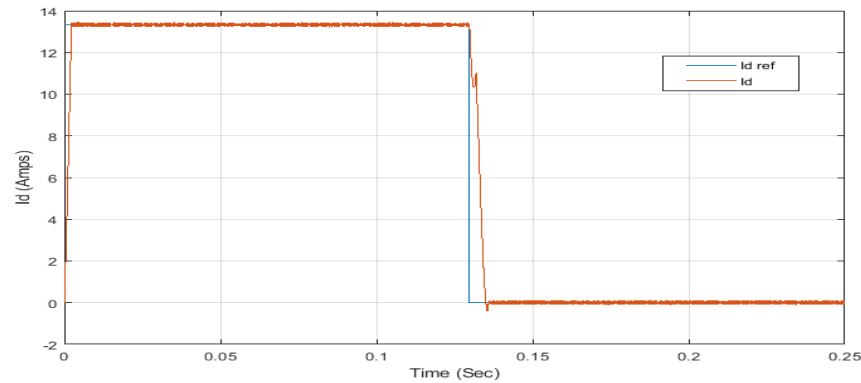


**Figure 4.4: Reactive Power (var) w.r.t Time (sec)**

From the fig 4.4 the reactive power at initial is 0 till the simulation time 0.135 sec, after that the reactive power goes on increasing up to the value of 10000 var.

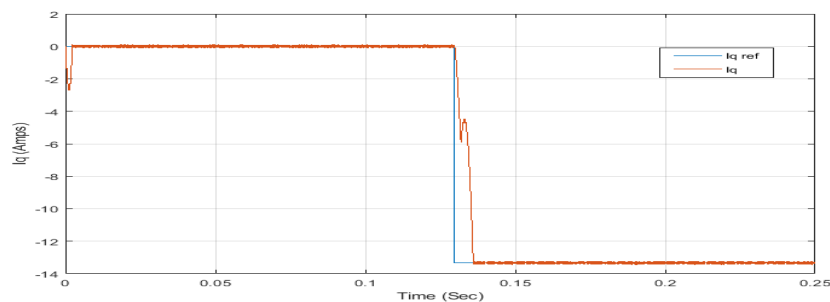


**Figure 4.5: Three Phase Voltages  $v_{an}$ ,  $v_{bn}$ ,  $v_{cn}$  of Grid Side Inverter w.r.t Time.**



**Figure 4.6: The Direct Axis Current  $i_d$ (amps) is Comparing with Reference w.r.t Time.**

We can observe the waveform in fig 4.6 the blue colour line represents the reference signal of the direct-axis of current and the orange line shows the actual output of the direct-axis current by the proposed control method(MPC) similarly the below fig.4.7 same as the blue line indicates the reference and the orange indicates actual output current  $i_q$ . The direct axis current  $i_d$  is approximately 13.5 amps. Similarly the  $i_q$  is -13.5 amps. From both figs if  $i_d$  is 0, then the  $i_q$  value goes to -13.5amps. if the  $i_q$  value is 0, then the  $i_d$  value goes to +13.5 amps.



**Figure 4.7:  $i_q$  Current w.r.t Time.**

## CONCLUSIONS

This paper proposed the active power and reactive power control for three-phase grid-connected inverter by the model predictive control (MPC). The simulation results prove that the system is strong and it has given better dynamic performance compared with classic controllers like pi controller the MPC has given the strong active power and reactive power regulation capability. And also we can observe all simulation results, they are like so smooth transition and fast response to active power and reactive power command of the proposed control system. The output ( $i_d, i_q$ ) currents mean the actual values are almost similar to that of reference values

## REFERENCES

1. Thong-In Suyata, Sakorn Po-Ngam and Chanlit Tarasantisuk "The Active Power and Reactive Power Control for Three-Phase Grid-Connected Photovoltaic Inverters" 978-1-4799-7961-5/15/\$31.00 ©20 15 IEEE.
2. J. Rodríguez, J. Pontt, C. Silva et al. "Predictive current control of a voltage source inverter," *IEEE Transactions on Industrial Electronics*, Vol. 54, No. 1, pp. 495–503, February 2007.
3. J. Holtz, "Pulsewidth modulation electronic power conversion," *Proceedings of the IEEE*, Vol. 82, No. 8, pp. 1194–1214, August 1994.



4. M. P. Kazmierkowski, R. Krishnan, and F. Blaabjerg, *Control in power electronics*. Academic Press, 2002
5. Hu, J., Shang, L., He, Y., & Zhu, Z. (2011). Direct active and reactive power regulation of grid-connected DC/AC converters using sliding mode control approach. *Power Electronics, IEEE Transactions on*, 26(1), 210-222.
6. Zhi, D., Xu, L., & Williams, B. W. (2009). Improved direct power control of grid-connected DC/AC converters. *Power Electronics, IEEE Transactions on*, 24(5), 1280-1292
7. W. Libo, Z. Zhengming, and L. Jianzheng, "A single-stage three-phase grid-connected photovoltaic system with modified MPPT method and reactive power compensation", *IEEE Trans. Energy Convers.*, Vol. 22, No. 4, pp. 881-886, Dec. 2007

