

DEVELOPMENT AND EVALUATION OF FINGER WHEEL AND CUTTING DISC COMBINED DEVICE FOR STALK RETURNING

I

拨禾指轮-锯盘组合式秸秆还田装置的研制与评价

Zhang Zhilong^{1,3}, Yu Yongtao¹, Yang Qiyong¹, Geng Aijun^{*1,3}, Zhang Ji^{1,2} ¹

¹

²

³

Tel: +86-0538-8242339; E-mail: gengaj@sdau.edu.cn

DOI: <https://doi.org/10.35633/inmateh-64-05>

Keywords: Stalk returning, Finger wheel, Sawtooth blade group, High speed photography, Test

ABSTRACT

Stalk returning technology was an important way to preserve soil nutrients and reduce soil erosion. It was of great significance to improve the stalk chopping quality, reduce power consumption. On the basis of the previous research, the finger wheel and cutting disc combined device for stalk returning was developed, mainly composed of the sawtooth blade group, the finger wheel and the stalk lifting grid. The stalk was fed into the cutting area of the sawtooth blades by the rotation of the finger wheel, and the operation of the stalk chopping was completed under the combination of the sawtooth blade group and the finger wheel. The movement of stalks in the device with finger wheel and sawtooth blades was analysed by high speed photography, and the rotational speed of finger wheel, the rotational speed of sawtooth blade group, the stalk feeding speed had a great influence on the movement of the stalks. Through orthogonal test and verification test, the clamping angle was 20° , the rotational speed of sawtooth blade group was 800 min^{-1} , the stalk feeding speed was 1.45 m/s , the rotational speed of finger wheel was 110 min^{-1} , the cut length qualified rate was 92.47% and the cutting power was 529.97 W . The test results met the quality requirements of the Chinese national standard. The related research can provide reference for the research of stalk returning device.

摘要

秸秆还田技术是保持土壤养分、减少土壤侵蚀的重要手段。提高秸秆切碎质量，降低能量消耗具有重要意义。在前期研究的基础上，研制了拨禾指轮-锯盘组合式秸秆还田装置，主要由锯齿刀片组、指轮和分禾栅板组成。秸秆通过指轮的转动送入锯齿刀片组的切割区，在锯齿刀片组和指轮的组合下完成秸秆的切割。通过高速摄影分析了秸秆在指轮和锯齿刀片组中的运动，得到指轮转速、锯齿刀片组转速、秸秆进给速度对秸秆的运动有很大的影响。通过正交试验和验证试验，确定钳住角为 20° ，锯齿刀片组转速为 800 min^{-1} ，秸秆进给速度为 1.45 m/s ，指轮转速为 110 min^{-1} ，切割长度合格率为 92.47% ，切割功率为 529.97 W 。检测结果符合中国国家标准的质量要求。相关研究可为秸秆还田装置的研究提供参考。

INTRODUCTION

The North China Plain (NCP) is the main grain production area in China and the predominant cultivation model is winter wheat-summer maize double cropping system (Ren B. et al, 2018). Soil fertility has declined, and environmental problems such as soil erosion by wind and water have been caused for long term conventional tillage methods (Blanco S.R. and Aguilar C. A., 2016; Topa D. et al, 2021). In order to realize the protection of cultivated land, many scholars have conducted research on conservation tillage technology, and the government has gradually promoted the use of conservation tillage in NCP (Dai X. et al, 2013). Conservation tillage is defined as an agricultural ploughing technology that leaves protective amount of residues on the soil surface, reduces water and wind erosion, and retains water and nutrients or other resources (Lopez-Garrido R. et al, 2014; Klik A. and Rosner J., 2020). The main content of conservation tillage includes stubble mulching, no-tillage fertilization and sowing, weed and pest control, subsoiling and topsoil operations (Moyer J.R. et al, 1994). As a dry farming technology that saves costs and increases yield, conservation tillage has been widely used in arid and semi-arid areas (He Jin et al, 2018).

¹ Zhang Zhilong, Lec. Ph.D. Eng.; Yu Yongtao; Yang Qiyong; Geng Aijun, Ph.D. Eng.; Zhang Ji

Stubble mulching means retaining residues on the soil surface which is an important way to improve organic matter level in the soil, and reduce wind and water erosion (Kim N. et al, 2021; Jia Honglei et al, 2015). As an important part of conservation tillage technology, straw returning has been widely used in NCP (Li H. et al, 2018). Due to the short interval between summer corn harvesting and wheat sowing, the wheat seeds would not be firmly attached to the seed bed if the full corn stalks are returned to the field, resulting in no emergence or hanging roots during the seedling stage (Li S. et al, 2006). Moreover, the crude protein content in the stalk lower part is low, and the nutrition in the middle and upper part of the stalks is better which can be used as high-quality roughage for livestock, and the suitable harvest height for stalk as feed is 100cm above the ground (Zhao H. et al, 2013; Wang M. et al, 2012).

The research team conducted the study on the rational use of stalk in sections and developed a high stubble maize double header with a saw-disc chopping device which could harvest the middle and upper part of the stalks and leave the rest chopped as residues (Zhang J. et al, 2018). In order to further improve the feeding performance and chopping effect of the mechanism, the research team improved the design of the returning device based on the preliminary research and conducted a bench test to obtain the better parameters. The results could provide a reference for the design of stalk returning mechanism and the rational utilization of corn stalks.

MATERIALS AND METHODS

Device structure

The finger wheel and cutting disc combined device for stalk returning which was located at the front and lower part of the header mainly consisted of sawtooth blade group, finger wheel, stalk-lifting grid etc., as shown in Fig.1. The sawtooth blade group was composed of several sawtooth blades which were arranged in an inverted cone shape, coaxial with and located below the stalk cutter. The finger wheel was installed between the sawtooth blade group, and was located at a middle position of the sawtooth blade group. The stalk-lifting grid, which consisted of series of grids, was located at the end of the cutting area of the sawtooth blade group (the contact area between the sawtooth blade group and the stalk was regarded as the cutting area), and several grids were evenly located among the sawtooth blades.

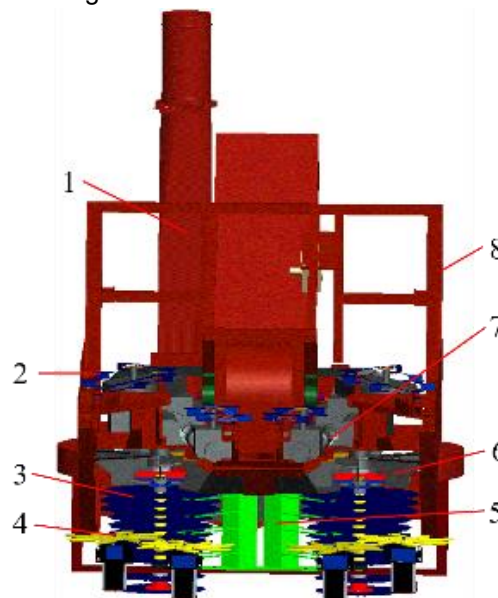

Fig. 1 - Finger wheel and cutting disc combined device for stalk returning

1. Throwing mechanism; 2. Gathering chain; 3. Sawtooth blade group; 4. Finger wheel; 5. Stalk-lifting grid; 6. Stalk cutter; 7. Snapping rollers; 8. Frame

The stalk returning device was driven by corn header and moved forward with the harvester. The plants were fed into the header, the upper part of the stalk was pulled down by the snapping rollers and chopped by the stalk cutter. The lower part of the stalk was fed into the sawtooth blade group, and chopped by rotating sawtooth blades with the support of the finger wheel. The lower part of the stalk was cut gradually from top to bottom as the rotation and forward movement of the sawtooth blades. When the incomplete cutting stalk contacted the stalk lifting grid, the stalk was cut by the sawtooth blades forcibly with the stalk lifting grid as the support, and then the stalks were chopped into pieces.

Analysis of key components

Sawtooth blade group

1. Structure parameter

The sawtooth blade group consisted of several sawtooth blades, a cutter shaft, a flange, a shaft sleeve, and a fixing nut, as shown in Fig.2. According to the stalk bending characteristics, the closer the stalk was to the root, the more bending strength the stalk would have (Xin Shanglong, 2020). The stalk would be pushed forward by the thrust force created by the sawtooth blades for the lower part of the stalk was fixed by the ground and the stalk could be taken as a cantilever beam. The upper stalk had not been completely cut off and the lower stalk would be sawed off the ground if the sawtooth blade diameter was the same, resulting in the fact that the upper stalk could not be completely sawed off. Therefore, the sawtooth blades were divided into 3 groups with the diameter decreasing from top to bottom in turn and showing an inverted cone shape. The two sawtooth blades were separated by an axle sleeve, and the cone angle was 22.6° (Zhang J. et al, 2018).

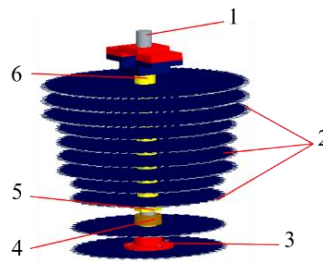

Fig. 2 - Sawtooth blade group

1. Cutter shaft; 2. Sawtooth blade; 3. Flange; 4. Self-aligning ball bearing; 5. Fixing nut; 6. Shaft sleeve

The distance between the blades was the key factor to determine whether the stalk could be cut and crushed. According to the preliminary experimental results of the research group, when the sawtooth blade spacing was greater than 30 mm, the stalks could only be cut into segments, and the sawtooth blade spacing was less than 30mm, the sawtooth blades had a crushing effect on the stalk. Therefore, the sawtooth blade spacing was taken as 25mm.

2. Force analysis of the stalk during cutting process

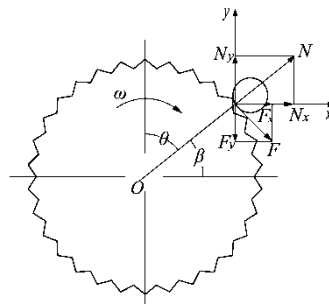

Fig. 3 - Force analysis of the stalk

The stalk was subjected to two forces, namely the tangential force F and the normal reaction force N acted on the stalk by the sawtooth blades (Fan Guochang et al, 1998).

The coordinate system was established with the contact point of the sawtooth blade and the stalk as the coordinate origin, and the force of the sawtooth blade to cut the stalk could be described as $F_x + N_x$ and the force of the sawtooth blade to clamp the stalk could be described as $F_y - N_y$. It was obvious that the condition for the sawtooth blade to clamp the stalk and make stable cutting was $F_y > N_y$, that was:

$$F \cdot \cos \beta > N \cdot \sin \beta \quad (1)$$

that was

$$f > \tan \beta \quad (2)$$

where, β -clamping angle; f -friction coefficient between the sawtooth blade and the stalk.

The friction coefficient between the sawtooth blade and the stalk f was between 0.3 and 0.6 (Lenaerts B. et al, 2014), it could be obtained that β was between 17° and 31° . In this study, the optimum parameters of clamping angle β were determined by orthogonal test.

Finger wheel

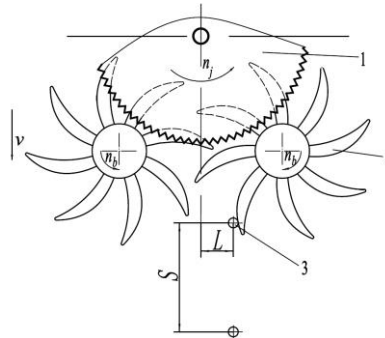

Fig. 4 - Schematic diagram of stalk feeding

1. Sawtooth blade; 2. Finger wheel; 3. Stalk

The finger wheel was arranged symmetrically in front of the sawtooth blade group, used to guide, feed the stalks to the sawtooth blade group and provide support for cutting to avoid missing cutting caused by stalk derivation which was induced by the centrifugal force generated by the sawtooth blade cutting the stalks. For this reason, the movement and the key parameters of the finger wheel was determined.

1. The condition for orderly feeding of the stalks

In order to cut the stalks smoothly, the stalks should be fed in an orderly manner by the finger wheel to avoid accumulation on the sawtooth blade group during the advancement of the header which would affect the cutting motion. The relative movement of the stalks in the feeding direction was shown in Fig.4.

Suppose that the stalk started to contact with the finger wheel from the position shown in Fig.4. In order to avoid feeding two plants to the finger wheel in the same time, the following relation should be satisfied:

$$\frac{S}{v} \geq \frac{60}{N \cdot n_b} \quad (3)$$

where, S is plant spacing, taking 250mm; v is forward speed, taking 1m/s; N is number of the finger, taking 8; n_b is rotational speed of finger wheel, min^{-1} .

It could be obtained: $n_b \geq 30 \text{ min}^{-1}$.

2. Parameters of the finger wheel

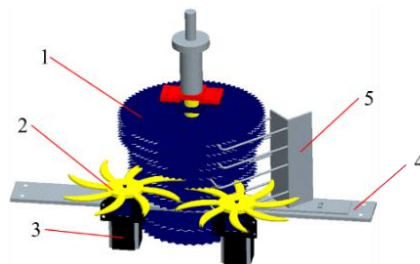

Fig. 5 - The position of finger wheel

1. Sawtooth blade group; 2. Finger wheel; 3. Motor; 4. Frame; 5. Stalk-lifting grid

The finger wheel was arranged between the sawtooth blades and driven by motor, as shown in Fig.5. In order to ensure that the stalks could be fed into the cutting position of the sawtooth blade group by finger wheel and the stalk leakage which was caused by collision from the finger wheel in the rotating process could be reduced, two finger wheels were set symmetrically in the front of the sawtooth blade group, a certain gap was set in the vertical direction and a certain overlap area was located between the two finger wheels. The outside diameter of the finger wheel was taken as 340 mm, and the centre distance of the two finger wheels was taken as 300 mm.

Stalk-lifting grid

The preliminary test showed that the finger wheel supported and assisted in cutting stalks in the forward direction, and most of the stalks would be cut under the joint action of the finger wheel and the sawtooth blades.

However, the stalk was subjected to a tangential force along the cutting direction in the process of cutting the stalks. If the stalk had not been completely cut by the sawtooth blades, the rest of the stalk would move along the cutting direction under the tangential force which could cause missing cutting the stalk. A stalk-lifting grid was designed at the end of the cutting area to avoid missing cutting, and the structure of the stalk-lifting grid was shown in Fig.6. The stalk-lifting grid was composed of a set of 6 mm round steel lifting rod which was interlaced with the sawtooth blade group.

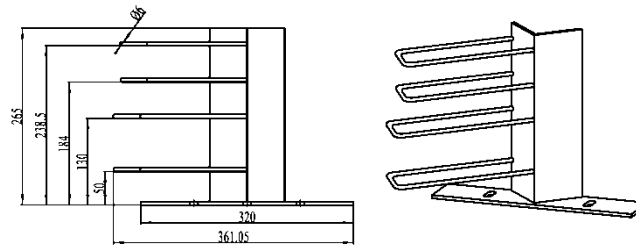

Fig. 6 - Stalk-lifting grid

Performance test

Test instruments and equipment

The experiment was carried out on a self-made test rig, which was composed of the stalk conveying device, the stalk returning device, the industrial computer and the motor, etc., as shown in Fig.7. The start and stop of the motor was controlled by the industrial computer, and the sawtooth blade group was driven by 7.5 kW variable-frequency adjustable-speed motor YVP132M-4. The finger wheels were respectively driven by the deceleration motor 4RK25GN-C. The conveying and feeding of the stalks were completed by the stalk conveying device.

The instruments used in the experiment included high-speed camera system and its analysis software Image-Pro Plus 6.3 (Cam Record 1000 high-speed camera, shooting frame speed of 1000-20000 fps, Optronis, Germany), YH502 dynamic torque sensor, light supplement lamp, electronic balance, meter ruler, vernier calliper, etc. The high-speed camera and light supplement lamp were shown in Fig.7.

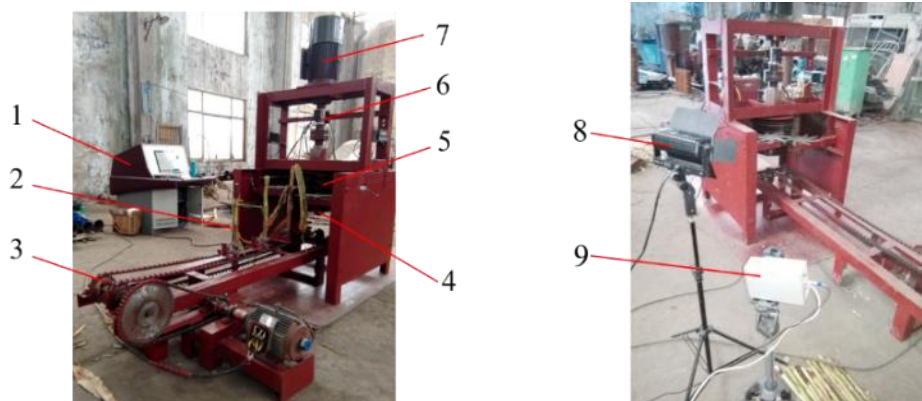

Fig. 7 - Stalk returning test rig

1. Industrial computer; 2. Stalks; 3. Stalk conveying device; 4. Deceleration motor 4RK25GN-C; 5. Stalk returning device; 6. Dynamic torque sensor YH502; 7. Variable-frequency adjustable-speed motor YVP132M-4; 8. Light supplement lamp; 9. High-speed camera

Test materials

The maize variety used in the experiment was Zhengdan 958, which was collected in the experimental field of Shandong Agricultural University, and the average moisture content of the stalks was 78.3 %. The stalks were cut from 10 cm above the soil surface, then the roots, tops were cut off, and the leaf sheathes, leaf covers were removed. The stalks which were 50 cm above the root were taken as the test samples. The average diameter of the big end and the small end of the stalks was respectively 22.34 mm, 19.21 mm.

Test methods and test indexes

The lower part of the stalks was fixed on the conveying device with clamps to put the stalks in a vertical state before the test. The rotation of the sawtooth blade group and the finger wheel was controlled by the industrial computer. After the rotational speed of the sawtooth blade group and the finger wheel was stabilized, the motor of the stalk conveying device was started, and the stalks were fed to the stalk returning device by the stalk conveying device. The stalks were cut by the sawtooth blade group with the support of the finger wheels.

The high-speed camera and its analysis software Image-Pro Plus 6.3 was used to collect and analyse the image information of the cutting area of the stalk returning device. The cutting power and cut length qualified rate were taken as performance test indexes.

1. Cutting power

The YH502 dynamic torque sensor was used to collect the torque information of the sawtooth blade group and the cutting power P_q was obtained by the equation (4-6).

$$P_q = P_z - P_k \quad (4)$$

$$P_z = \frac{T_z n}{9550} \quad (5)$$

$$P_k = \frac{T_k n}{9550} \quad (6)$$

where, T_k -idling torque, N·m; T_z -total operating torque, N·m; P_k -idling power, W; P_z -total operating power, W.

2. Cut length qualified rate

After the experiment, an electronic balance was used to weigh the total mass of the chopped stalks and the total mass of the chopped stalks the cutting length of which was more than 25 mm. The cut length qualified rate F_h could be obtained by equation (7).

$$F_h = \frac{m_z - m_b}{m_z} \quad (7)$$

where, m_z was the total mass of the chopped stalks, kg; m_b was the total mass of the chopped stalks the cutting length of which was more than 25 mm, kg.

Test plan

The theoretical analysis showed that the clamping angle β had a major influence on the stable and reliable cutting of the stalks, so the clamping angle β was taken as a factor for the performance test. In addition, the rotational speed of the finger wheel, stalk feeding speed (machine forward speed) and the rotational speed of the sawtooth blade group were selected as the test factors which had major influence on the test indexes.

After the single-factor test in the early stage, the operation effect was better when the rotational speed of the finger wheel was 80~140 min^{-1} , the stalk feeding speed was 1.1~1.80 m/s, the clamping angle was 15~25°, and the rotational speed of the sawtooth blade group was 700~900 min^{-1} . In order to determine the optimal combination, a four-factor and three-level orthogonal test was designed, and the factor level table was shown in Table 1.

Table 1

Test factors and levels

| Levels | Factors | | | |
|--------|---|---|---|----------------------------|
| | A Rotational speed of the sawtooth blade group (min^{-1}) | B Stalk feeding speed ($\text{m}\cdot\text{s}^{-1}$) | C Rotational speed of the finger wheel (min^{-1}) | D Clamping angle (°) |
| 1 | 700 | 1.10 | 80 | 15 |
| 2 | 800 | 1.45 | 110 | 20 |
| 3 | 900 | 1.80 | 140 | 25 |

RESULTS

Motion analysis of the stalks in the stalk returning device

High-speed photography was used to analyse the motion of the stalks in the cutting process. After the preliminary experiment, the process of stalk cutting could be divided into two steps: stalk feeding and stalk chopping. The movement of the stalk in the feeding step was shown in Fig.8.

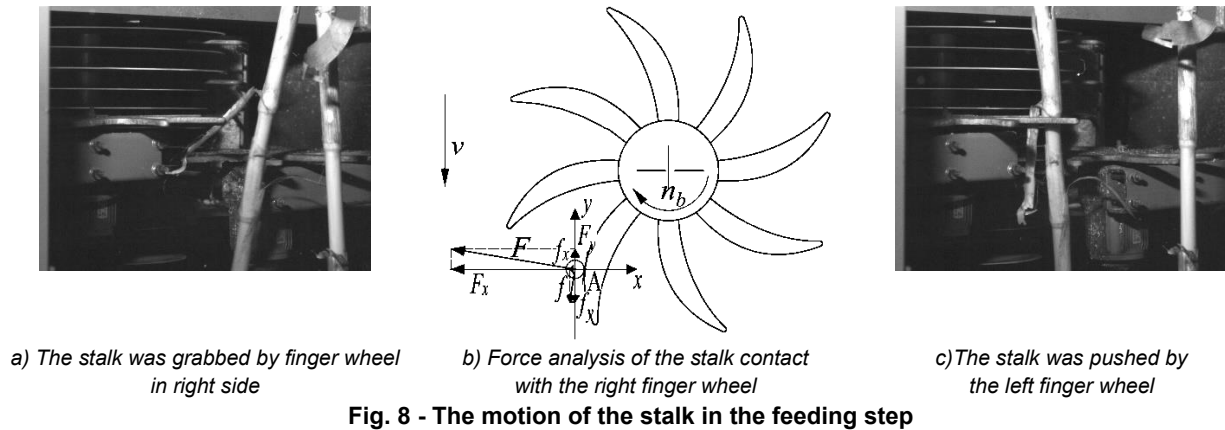

Fig. 8 - The motion of the stalk in the feeding step

As the stalk returning device moved forward, the stalk was grabbed by the finger wheel and fed in the direction of the sawtooth blade group as shown in Fig.8a. The stalk was impacted by the right finger wheel, and the stress of the stalk was shown in Fig.8b. Suppose that the stalk was in contact with the finger wheel at point A. The stalk was affected by the thrust F and the friction force f of the finger wheel. The direction of the thrust F was the normal line of the contact point between the stalk and the finger wheel. The direction of the friction force f was the tangent direction of the contact point.

A coordinate system was established with the geometric centre of the stalk as the coordinate origin, the thrust force F and the friction force f on the stalk were decomposed towards the x -axis and the y -axis respectively. The horizontal force of the stalk was the resultant force of F_x and f_x . The resultant force in the left direction caused the stalk to accelerate and move to the left. In addition, the stalk also had a relative speed moving toward the sawtooth blade group. Therefore, the movement of the stalk was a combination of the movement to the left and the movement to the sawtooth blade group. When entering the movement area of the left finger wheel, the stalk would gradually move to the cutting area under the push of the left finger wheel, as shown in Fig.8c. It could be concluded from the above analysis that the rotational speed of the finger wheel and stalk feeding speed had a major influence on the motion of the stalk in the feeding step.

The movement of the stalk in the returning device during cutting step was shown in Fig.9. The bending resistance of the stalk indicated that the upper part of the stalk was more flexible than the lower part. The inverted cone structure of the sawtooth blade group made the upper part enter the cutting area first, as shown in Fig.9a. The stalk was subjected to the tangential force F_{ct} , the normal force F_{cn} of the sawtooth blade, and the supporting force F_p of the finger wheel. A coordinate system was established with the centre of the stalk as the coordinate origin, and the force of the stalk was decomposed in the horizontal and vertical directions, as shown in Fig.9b. The upper part of the stalk was cut by the sawtooth blade with the support of the finger wheel for the support force F_{py} on the stalk from the finger wheel in the y -axis direction. The stalk was subjected to the component force F_{ctx} of the tangential force and the component force F_{px} of the supporting force of the finger wheel in the x -axis direction, and the rotating direction of the finger wheel was the same as that of the sawtooth blade group. Therefore, after the upper part of the stalk was cut, the middle and lower parts of the stalk successively entered the right cutting area of the sawtooth blade group, as shown in Fig.9c.

The force of the stalk in the right cutting area was shown in Fig.9e. The stalk was subjected to the tangential force F_{dt} from the sawtooth blade, the normal force F_{dn} from the sawtooth blade, and the supporting force F_q from the finger wheel. The coordinate system was established with the centre of the stalk as the coordinate origin, and the forces on the stalk were decomposed. The stalk was subjected to the supporting force F_{qy} from the finger wheel and the component force F_{dty} of the tangential force in the y -axis direction.

Due to the supporting forces F_{qy} and F_{dty} , the stalk was clamped by the sawtooth blade group and the stalk would not be bounced under the component force F_{dny} of the normal force from the sawtooth blade. In the x -axis direction, the stalk was subjected to the horizontal component force F_{dtx} of tangential force, and the horizontal component force F_{dnx} of normal force, which caused the stalk to accelerate to the right, so that the stalk moved along the rotation direction of the sawtooth blade. Therefore, the stalk would move in the direction of rotation of the sawtooth blades under the combined action of the sawtooth blades and the finger wheel during the cutting process, as shown in Fig.9d. The chopped stalk segments were thrown along the direction of rotation of the sawtooth blade under the cutting forces from the sawtooth blades.

Variance analysis

In order to determine the influence of various factors on the test indexes, the variance analysis was carried out on each test index, as shown in Table 3.

Table 3

Variance analysis results

| Index | Source of variance | Deviation sum of squares S | Degrees of freedom f | F ratio | Reliability α | F_{α} | Significance marker |
|---------------------------|--------------------|----------------------------|----------------------|---------|----------------------|--------------|---------------------|
| Cut length qualified rate | Factor A | 270.69 | 2 | 3.59 | 0.05 | 3.35 | ※ |
| | Factor B | 388.529 | 2 | 5.15 | 0.05 | 3.35 | ※ |
| | Factor C | 131.24 | 2 | 1.74 | 0.25 | 1.46 | [※] |
| | Factor D | 522.15 | 2 | 6.92 | 0.01 | 5.49 | ※※ |
| | Error E | 1018.04 | 27 | — | — | — | — |
| | Sum | 2330.65 | 35 | — | — | — | — |
| Cutting power | Factor A | 375780.12 | 2 | 17.92 | 0.01 | 5.49 | ※※ |
| | Factor B | 37865.53 | 2 | 1.8058 | 0.25 | 1.46 | [※] |
| | Factor C | 104196.97 | 2 | 4.97 | 0.05 | 3.35 | ※ |
| | Factor D | 135158.94 | 2 | 6.45 | 0.01 | 5.49 | ※※ |
| | Error E | 283086.78 | 27 | — | — | — | — |
| | Sum | 936088.34 | 35 | — | — | — | — |

$F_{0.25}(2,27) = 1.46$, $F_{0.10}(2,27) = 2.51$, $F_{0.05}(2,27) = 3.35$, $F_{0.01}(2,27) = 5.49$
 $F_{\text{factor}}(2,27) > F_{0.01}(2,27)$, the influence of factor on the test index was highly significant, marked as ※※;
 $F_{0.01}(2,27) \geq F_{\text{factor}}(2,27) > F_{0.05}(2,27)$, the influence of factor on the test index was significant, marked as ※;
 $F_{0.10}(2,27) \geq F_{\text{factor}}(2,27) > F_{0.25}(2,27)$, the influence of factor on the test index was not significant but has an influence, marked as [※]

The results of the variance analysis showed that the clamping angle β had a highly significant effect on the cut length qualified rate among the four factors examined in the test, and the judgment reliability was 99%. The rotational speed of the sawtooth blade group and the stalk feeding speed had a significant influence on the cut length qualified rate and the judgment reliability was 95%. The rotational speed of the finger wheel had no significant influence on the cut length qualified rate, but it had an influence, and the judgment reliability was 75%. Therefore, the primary and secondary order of each factor affecting the cut length qualified rate was clamping angle (D), stalk feeding speed (B), rotational speed of the sawtooth blade group (A), rotational speed of the finger wheel (C).

The rotational speed of the sawtooth blade group and the clamping angle β had a highly significant effect on the cutting power, and the judgment reliability was 99%. The rotational speed of the finger wheel had a significant influence on the cutting power and the judgment reliability was 95%. The stalk feeding speed had no significant influence on the cutting power, but it had an influence, and the judgment reliability was 75%. Therefore, the primary and secondary order of each factor affecting the cutting power was rotational speed of the sawtooth blade group (A), clamping angle (D), rotational speed of the finger wheel (C) and stalk feeding speed (B).

When the optimal combination was determined, the cut length qualified rate should be set as a large value, and the cutting power as a small value. The cut length qualified rate was more important than the cutting power for the performance of the machine. Therefore, combined with the results of variance analysis, the optimal combination of the test was finally selected as D2, A2, B2 and C2, that was, the clamping angle was 20° , the rotational speed of the sawtooth blade group was 800 min^{-1} , the stalk feeding speed was 1.45 m/s , and the rotational speed of the finger wheel was 110 min^{-1} .

Verification test

In order to verify the effect of the optimal combination, the experimental conditions were set as follows: clamping angle was 20° , the rotational speed of the sawtooth blade group was 800 min^{-1} , the stalk feeding speed was 1.45 m/s , and the rotational speed of the finger wheel was 110 min^{-1} . Verification tests were carried out on the test rig, 3 plants were taken in each group of tests and repeated for 10 times. The test results were shown in Table 4.

Table 4

Verification test results

| Test No. | Cut length qualified rate (%) | Cutting power (W) |
|----------|-------------------------------|-------------------|
| 1 | 92.40 | 507.96 |
| 2 | 91.34 | 551.31 |
| 3 | 93.15 | 590.89 |
| 4 | 94.94 | 536.23 |
| 5 | 89.72 | 563.56 |
| 6 | 89.64 | 518.32 |
| 7 | 97.58 | 490.99 |
| 8 | 90.86 | 417.49 |
| 9 | 89.67 | 563.56 |
| 10 | 95.38 | 559.40 |
| Mean. | 92.47 | 529.97 |

It could be obtained from Table 4 that the cut length qualified rate was 92.47% and the cutting power was 529.97 W. The qualified rate of chopped length was greater than the requirement of Chinese national standard NY/T 1004-2006. The views of the chopped stalks were shown in Fig.10.



Fig. 10 - Views of the chopped stalks

CONCLUSIONS

1. A finger wheel and cutting disc combined device for stalk returning was developed. The stalks were grabbed and held by the finger wheel and then fed into the sawtooth blade group. The stalks were crushed off the ground by the cooperation of the finger wheel and the sawtooth blade group.

2. The motion of the stalk in the stalk returning device was analysed by means of high-speed photography, and it was found that the rotational speed of the finger wheel, the rotational speed of the sawtooth blade group and the feeding speed had considerable impact on the motion of the stalk.

3. The test results showed that the operation effect of the stalk returning device was better when the clamping angle β was 20° , the rotational speed of the sawtooth blade group was 800 min^{-1} , the stalk feeding speed was 1.45 m/s , and the rotational speed of the finger wheel was 110 min^{-1} . A verification test was carried out and the test results showed that the cut length qualified rate was 92.47%, and the cutting power was 529.97 W in the optimized parameters combination.

ACKNOWLEDGEMENT

This work was supported by 13th Five-Year National Key R & D Program (2018YFD0300606), Shandong Provincial Key Science and Technology Innovation Engineering Project (2018CXGC0217).

REFERENCES

- [1] Blanco S. R., Aguilar C. A., (2016), The erosion threshold for a sustainable agriculture in cultures of bean (*Phaseolus vulgaris L.*) under conventional tillage and no-tillage in Northern Nicaragua. *Soil Use and Management*, Vol.32, Issue 3, pp. 368-380, Málaga/Spain.
- [2] Dai X., Li Y., Ouyang Z., Wang H., Wilson G.V, (2013), Organic manure as an alternative to crop residues for no-tillage wheat-maize systems in North China Plain. *Field Crops Research*, Vol.149, pp. 141-148, Beijing/China.
- [3] Fan Guochang, Ma Damin, Ji Junjie, Liu Huanxin, (1998), Study on sawtooth cutters of double disk. *Journal of Hebei Agrotechnical Teachers College*, Vol.12, issue 2, pp.40-43. Shijiazhuang/China.
- [4] He Jin, Li Hongwen, Chen H., Lu Caiyun, Wang Q, (2018), Research progress of conservation tillage technology and machine. *Transactions of the Chinese Society for Agricultural Machinery*, Vol.49, issue 4, pp.1-19. Beijing/China
- [5] Jia Honglei, Wang Gang, Li Guo, Zhuang Jian, Tang Lie, (2015), Wind erosion control utilizing standing corn residue in Northeast China. *Soil and Tillage Research*, Vol.153, pp.112-119. Changchun/China.
- [6] Kim N., Riggins C.W., Rodríguez-Zas S., Zabaloy M.C., Villamil M.B, (2021), Long-term residue removal under tillage decreases amoA-nitrifiers and stimulates nirS-denitrifier groups in the soil. *Applied Soil Ecology*. doi:10.1016/j.apsoil.2020.103730. Illinois/USA.
- [7] Klik A., Rosner J., (2020), Long-term experience with conservation tillage practices in Austria: Impacts on soil erosion processes. *Soil and Tillage Research*, Vol.203, pp. 1-14, Vienna/Austria.
- [8] Lenaerts B., Aertsen T., Tijsskens E., Ketelaere B.D., Ramon H., Baerdemaeker J.D., Saeys, W, (2014), Simulation of grain-straw separation by Discrete Element Modeling with bendable straw particles. *Computers and Electronics in Agriculture*, Vol.101, pp.24-33. Leuven/Belgium.
- [9] Li H., Dai M., Dai S., Dong X., (2018), Current status and environment impact of direct straw return in China's cropland-A review. *Ecotoxicology and Environmental Safety*, Vol.159, pp.293-300. Hefei/China.
- [10] Li S., Wang K., Feng J., Xie R., Gao S., (2006), Factors affecting seeding emergence in winter wheat under different tillage patterns with maize stalk mulching returned to the field. *Acta Agronomica Sinica*, Vol.32, issue 3, pp.463-465. Beijing/China.
- [11] López-Garrido R., Madejón E., Moreno F., Murillo J.M., (2014), Conservation tillage influence on carbon dynamics under Mediterranean conditions. *Pedosphere*, Vol.24, issue 1, pp.65-75. Seville/Spain.
- [12] Moyer J.R., Roman E.S., Lindwall C.W., Blackshaw R.E, (1994), Weed management in conservation tillage systems for wheat production in North and South America. *Crop Protection*, Vol.13, issue 4, pp.243-259. Alberta/Canada.
- [13] Ren B., Li X., Dong S., Liu P., Zhao B., Zhang J., (2018), Soil physical properties and maize root growth under different tillage systems in the North China Plain. *The Crop Journal*, Vol.6, issue 6, pp.669-676. Tai'an/China.
- [14] Topa D., Cara I. G., Jitäreanu G, (2021), Long term impact of different tillage systems on carbon pools and stocks, soil bulk density, aggregation and nutrients: A field meta-analysis. *CATENA*. Iasi/Romania. doi:10.1016/j.catena.2020.105102.
- [15] Wang M., Zhong R., Zhou, D., (2012), Research on appropriate harvesting time of corn and utilization mode of straw forage. *Agricultural Research in the Arid Areas*, Vol.30, issue 3, pp.18-25. Changchun/China.
- [16] Xin Shanglong, (2020), *Study on the mechanism and key technology of corn ear picking with vertical roller*. Gansu agricultural university, Lanzhou/China.
- [17] Zhang J., Yu Y., Yang Q., Zhang J., Zhang Z., Geng A., (2018), Design and experiment of smashed straw unit for high stubble maize double header. *Transactions of the Chinese Society for Agricultural Machinery*, Vol.49, issue S1, pp.42-49. Tai'an/China.
- [18] Zhao H., Ning T., Nie L., Wang B., Tian S., Li Z., (2013). Comparison of yields and nutrient compositions between different harvesting heights of maize stover. *Scientia Agricultura Sinica*, Vol.46, issue 20, pp.4354-4361. Tai'an/China.