



Metamaterial Inspired Reconfigurable Fractal Monopole Antenna for Multiband Applications

**Pardhasaradi Pokkunuri¹ Boddapati Taraka Phani Madhav^{1*} Gullapalli Kesava Sai¹
 Manikonda Venkateswararao¹ Bonthu Ganesh¹ Nimmagadda Tarakaram¹
 Dangeti Pavana Teja¹**

¹*Department of Electronics and Communication Engineering,
 Koneru Lakshmaiah Education Foundation, AP, India*

* Corresponding author's Email: btpmadhav@kluniversity.in

Abstract: The multiband reconfigurable fractal slot antenna which is having Split ring resonator and complementary split ring resonator is proposed in this article. The proposed antenna works at the bands of GPS (1.6GHz), Bluetooth (2.4GHz) and at the middle of the WiMAX bands (5.7GHz). In respect to that, the frequency reconfigurability of the proposed antenna has been tested and analysed by placing PIN diode which is attached to Complimentary Split Ring Resonator (CSRR) at the backside (ground) of the antenna. The switchable characteristics of the antenna are tested using two diodes. When ON condition the switching characteristics are seen in the lower bands such as 1.8GHz (B.W=18%) and WiMAX 3.5GHz band (B.W=20%).during OFF condition the lower frequency band of GPS is converted as the notch band and increase of about 20% B.W has been observed in Bluetooth 2.4GHz and 5.6 UPPER WiMAX bands. The compact antenna of size 35mm*30mm is designed and analysed using ANSYS EM Desktop. The gain and stable radiation patterns with radiation efficiency towards frequency have been observed in the article.

Keywords: Complimentary split ring resonator (CSRR), Fractal, Reconfigurability, Split ring resonator (SRR).

1. Introduction

Meta-materials are materials that are made of subwavelength unit cells which can exhibit properties specific for them such as negative refractive index. A Metamaterial generally consists of multiple individual elements called as 'Meta-Atoms' which each has a size much smaller than the wavelength that interacts with. These unit cells are microscopically built from conventional materials such as metals and dielectrics like plastics. However, their exact shape, geometry, size, orientation, and arrangement can macroscopically affect light in an unconventional manner such as creating resonances or unusual values for macroscopic permittivity and permeability. Some examples of available metamaterials are negative index metamaterials, chiral metamaterials, plasmonic metamaterials, photonic metamaterials, etc [1]. Due to their subwavelength nature, metamaterials that operate at

microwave frequencies have a typical unit cell size of a few millimetres, while metamaterials operating at the visible part of the spectrum have a typical unit cell size of a few nanometres. Metamaterials are also inherently resonant, i.e. they can strongly absorb light at a certain narrow range of frequencies that can block or absorb a colour in the spectrum. For conventional materials, the electromagnetic parameters such as magnetic permeability and electric permittivity arise from the response of the atoms or molecules that make up the material to an electromagnetic wave being passed through. Recently, metamaterials have garnered significant attention for implementing smart antennas due to the exclusive and exotic properties such as the possibility of tailoring μ and ϵ , negative refractive index, anti-parallel group, and phase velocities. The application of the afore mentioned properties leads to miniaturization, bandwidth enhancement, multiband operation, and better radiation efficiency

in a metamaterial-loaded antenna. The metamaterial consists of different types of structures such as complementary split ring resonator (CSRR), pentagonal SRR, triangular SRR, L-dumbbell-shaped, etc. In the case of metamaterials, these electromagnetic properties are not determined at an atomic or molecular level. Instead, these properties are determined by the configuration of a collection of smaller objects that make up the metamaterial. Although such a collection of objects and their structure do not appear at an atomic level like a conventional material, a metamaterial can nonetheless be designed so that an electromagnetic wave will pass through as if it were passing through a conventional material. Furthermore, because the properties of the metamaterial can be determined from the composition and structure of such small (Nanoscale) objects, the electromagnetic properties of the metamaterial such as permittivity and permeability can be accurately tuned on a very small scale [2]. Reconfigurable technology has been widely applied in various fields. With the rapid demands of increased functionality of wireless communication, this technology appeared in different antenna systems, and therefore a great diversity of reconfigurable antenna elements has been proposed [3]. Generally, the common reconfigurable performance of antenna elements includes polarization, radiation pattern, frequency, as well as a combination of the above. These reconfigurable elements significantly satisfy the requirements of modern wireless applications [4]. The ability to cover several frequency bands with a single antenna that exhibits desirable gain, stable radiation pattern and wide bandwidth is presently a challenging topic for antenna engineers. To cover all operating bands of interest, the most common method is to design a wideband antenna. However, unwanted signals and noises will be received by the non-operating bands of such antenna type. Therefore, antenna design with selectable frequency bands (frequency reconfigurable) can provide an alternative solution for a wireless communication system that only requires a certain operating band. To achieve reconfigurability, the PIN diode is usually chosen to be the preferred switching mechanism, because of its fast switching speed, reliability, and ease in modelling [5]. Md. Rezwanaul Ahsan proposed that new triangular fed planar antenna which is applicable to Wireless communication standard applications like Wi-MAX, Wi-fi [6]. However, the degree of miniaturization is too low for this antenna and only operates at three different frequency bands 2.16–2.79 GHz/ 3.27–3.87 GHz/ 5.28–5.97 GHz while referred to their

central frequency as 2.49, 3.54 and 5.6 GHz respectively. Abdelheq Boukarkar proposed to integrate dual-band antenna by minimizing the patch area and etching for multiband operations [7] which is recommended for point to point communications. Along with this Triple band and further Quad -band antennas are designed respectively which use single feedline structures. Ritesh Kumar Saraswat proposed an Ultra-wideband miniaturized antenna with slotted ground structures and fractalization of radiating edge [8]. IEEE Standard WiMAX and WLAN bands are achieved by using the slotted ground structures. This antenna has omnidirectional radiation patterns in H-plane for the frequency bands in the interest of the antenna, which are basically the Wireless band applications. However, the degree of the miniaturisation of this model is only 27.28%. Tanweer Ali proposed a fractal L shaped quad-band antenna with metamaterials and by using a circular SRR the introduction of metamaterial in the ground plane [9] makes the antenna operate at 3.3 GHz (middle WiMAX). The etching of Serpins triangle and L-shaped slot in the radiating monopole perturbs the surface current distribution. Hung, Tian-Fu, presented an article based on the design of the aperture-coupled stack antenna with a complementary Minkowski-island-based (MIB) fractal geometry for 3.56/5.28 GHz dual-band CP applications is presented [10]. By the perturbation and MIB fractal, the dual-modes exists in the asymmetrical square patch to present wideband and CP characteristics. Tanweer Ali, proposed a compact quad-band reconfigurable antenna with a trapezoidal slot in the patch and etching the ground which makes the surface current path altered making it work as multiple frequency bands [11]. While the reconfiguration is achieved by using the PIN DIODE which can be used at different applications such as GNSS, Wi-MAX, WLAN and X-Band applications. Tanweer Ali, presented novel miniaturized multiband antenna [12] using the kite-shaped slot utilized in the radiating patch as this provides high degree of miniaturization in active patch area and volume (i.e., 26 and 50%) and the G- and C-shaped slots etched out in the ground plane have the speciality of independently controlling the respective individual operating band (i.e., G-shaped slot control 3.6 and 5.8 GHz bands and C-shaped slot control 6.9 and 9.5 GHz bands), thus having the advantage over the slotted multiband antenna proposed in [6 - 11] and the aforementioned structures (i.e., kite-, G- and C-shaped slots) are placed in the proposed antenna such that it yields acceptable gain, good impedance matching and

stable radiation patterns across the operational bandwidths [12 - 14].

In this paper, we proposed a frequency reconfigurable fractal (Koch Fractal) slot antenna using CSRR. Reconfiguration is achieved by using two PIN diodes. The proposed antenna is manufactured on the FR4 substrate with a relative permittivity of 4.4 and with a loss tangent of 0.02 with a thickness of 1.6. The proposed antenna uses CSRR which incorporates the PIN diodes as part of the defected ground structures. This work focussed on a novel fractal slot antenna using complimentary split ring resonator. To achieve frequency reconfigure we used pin diodes. By using this technique, the frequency is reconfigured as shown in s-parameters. As to show the superiority of the proposed model, we have compared it with the existing literature. The proposed antenna provides six bands for reconfiguration in between 2 to 6 GHz. The proposed antenna generates hex-band for reconfiguration for different applications in the frequency range of 2 to 6 GHz. This paper is divided into different sections which describe Introduction as section 1, Antenna Design as section 2, Results as section 3, Reconfigurability as section 4 and conclusion as section 5.

2. Antenna construction

The proposed multiband antenna with a detailed explanation with parameters is illustrated in the figure. The proposed antenna is fabricated on FR4 material which consists of permittivity 4.4 and loss tangent 0.02. The proposed related to the Koch fractal antenna having snowflake patch as the radiating element. The flip view of the antenna is grounded with some slotted structures and with a CSRR. The proposed antenna is having a thickness of 1.6mm and it is excited with 50ohms using SMA connector.

The conventional equilateral triangle shaped antenna is designed as iteration 1. Here antenna shows triple band operations at 2.3/2.8/4.0. The Radiating patch i.e. the triangle shaped patch on top of the structure and the slots in the ground plane is responsible for the triple band resonance.

The concept of Koch Fractal is introduced with the help of snowflake shaped patch. Here introducing this Koch fractal shape, the traditional equilateral triangle (iteration 1) is miniaturized i.e. dimensions are changed from 80x62 mm² are changed to 56x55 mm². With respect to that, the multiband operations exhibit in the antenna 2. The antenna 2 works in the bands 2.3/2.7/3.9/4.4/4.0.

The increase in the number of working bands is due to the modifications done in the patch antenna.

In the Iteration 3 to increase the input impedance of the antenna the patch is further modified with snowflake structure the compact size of 35x30 mm² approximately 86% reduction in the volume of the antenna. Active participation of the patch area is seen. The final step involves the introduction of complementary split ring resonator on the ground. The CSRR is etched from the bottom of the ground which affects the current distributions of the antenna geometry. A slight shift in the multiband operations and addition of another band is observed in the Proposed Antenna. Since the shifts are marginal the bandwidth falls in between the Bluetooth, Wi-MAX, sub six band range.

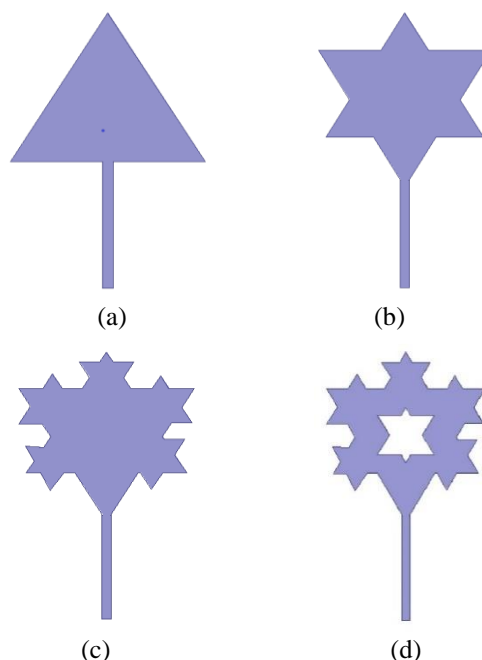
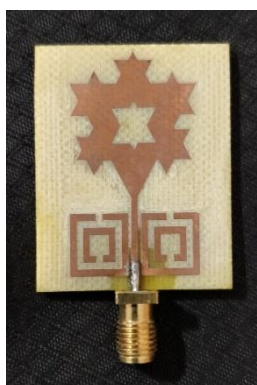
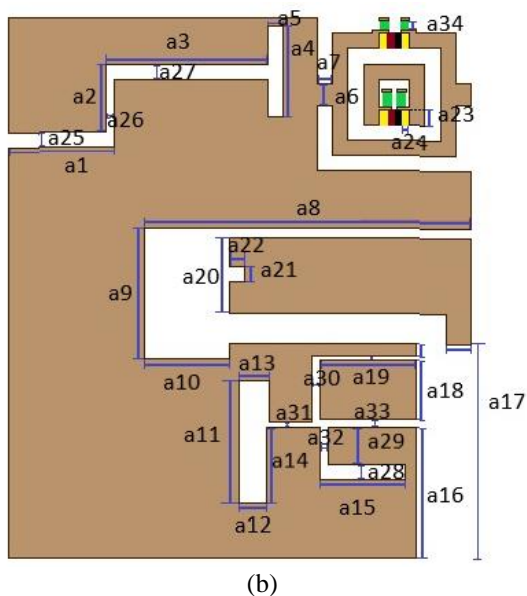
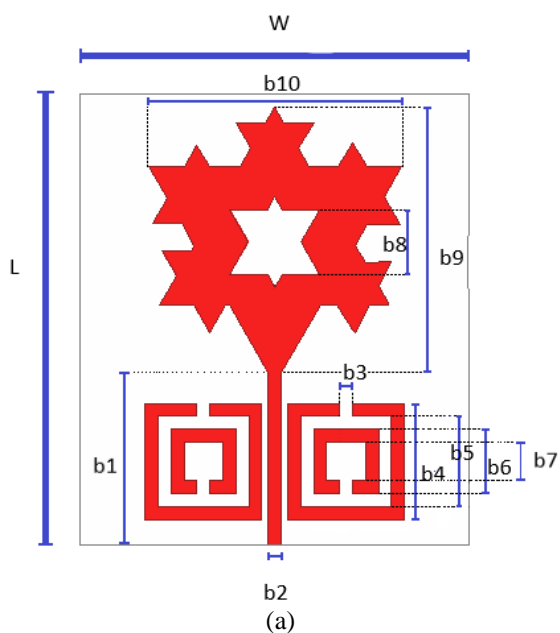

Figure. 1 Different iterations for patch design: (a) iteration1, (b) iteration2, (c) iteration3, and (d) iteration4

Table 1. Proposed antenna geometry for front

Variable	Dimension in mm
L	35
W	30
b1	13.25
b2	1
b3	1
b4	9
b5	7
b6	5
b7	3
b8	5
b9	21
b10	19.5



(c)

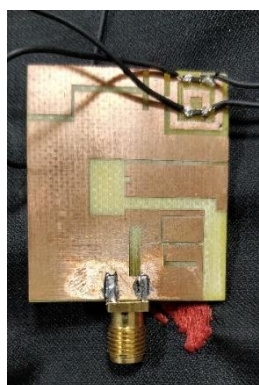

(d)

Figure. 2 Proposed Antenna: (a) front view, (b) back view, (c) fabricated antenna front view, and (d) fabricated antenna back view

Table 2. Proposed antenna geometry for back side

Variable	Length in mm
a1	6.8
a2	4.5
a3	10.5
a4	6
a5, a7, a27, a21, a22, a23, a25, a28	1
a6	1.4
a8	21.2
a9	8.5
a10	5.5
a11	7.9
a12	1.8
a15	5.5
a16	8.4
a17	13.8
a18	3.85
a19	6.2
a20	4.85
a24, a26, a32, a33, a34	0.5
a29	2.4
a31	0.3
a35	2
a36	6.85
a37	14
a38	2
a39	1.6
a40	0.25

The proposed antenna is constructed using the following equations.

The operating wavelength ' λ_0 ' of the proposed antenna is calculated as given in Eq. (1),

$$\lambda_0 = \frac{c}{f_r} \tag{1}$$

Where, ' c ' is the velocity of light in free space ' f_r ' is the resonant frequency.

The thickness of the substrate (h_s) is given by:

$$h_s \leq \frac{0.3C}{2\pi f_r \sqrt{\epsilon_r + 1}} \tag{2}$$

Where, ϵ_r is relative dielectric constant.

The width of the strip (w_s) is given by:

$$w_s = \frac{C}{2f_r} \sqrt{\frac{2}{\epsilon_r + 1}} \tag{3}$$

The effective length (ΔL) due to effective dielectric constant is:

$$\Delta L = 0.412 h_s \left\{ \frac{\epsilon_r + 0.3}{\epsilon_r - 0.258} \right\} \left\{ \frac{\frac{W_s}{h_s} + 0.264}{\frac{W_s}{h_s} + 0.813} \right\} \quad (4)$$

The length of the patch (L_d) is:

$$L_d = \left\{ \frac{C}{2 f_r \sqrt{\epsilon_{\text{reff}}}} \right\} - 2 \Delta L \quad (5)$$

By using the above equations, the dimensions and parameters of the proposed antenna has been taken. After taken this dimensions the metamaterial inspired complimentary split ring resonator is an added advantage to the proposed model.

3. Results and discussion of proposed antenna

The Proposed antenna with its iterations has been seen in Fig. 3. It is observed that the antenna 1 works at triple band applications. The antenna 1 works in the region of 2.2/2.9/3.9 GHz. The antenna 2 is converted to an equilateral triangle to snowflake radiating patch thus it also gives a triple band

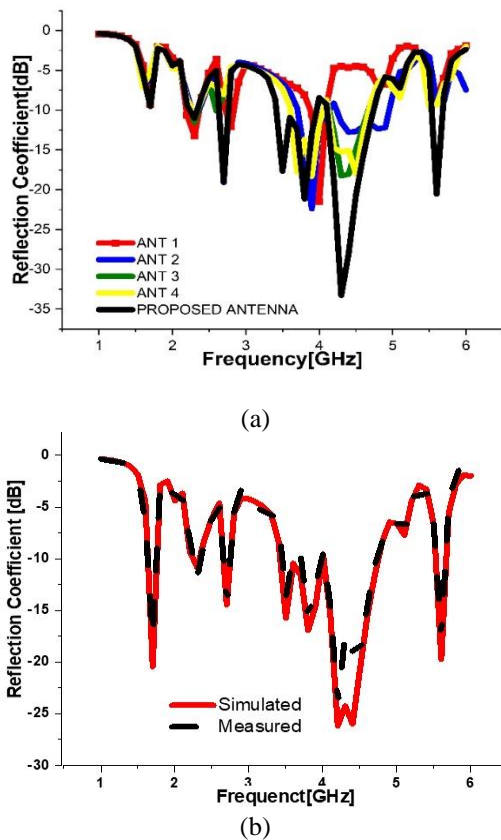

Figure. 3 Proposed antenna with its iterations: (a) proposed antenna simulated results for different iterations and (b) simulated and measured S_{11}

operation. In antenna 3 and antenna 4 the patch has been modified with snowflake type of structure where all sides of the patch resulting in the quad-band operation. And snowflake structure slotted in the patch in antenna 4 results in the multiband operation has been at all sides of the patch resulting in the quad-band operation. As to increase the bandwidth of the multiband structure the proposed antenna is attached with a split ring resonator at both sides of the feed line.

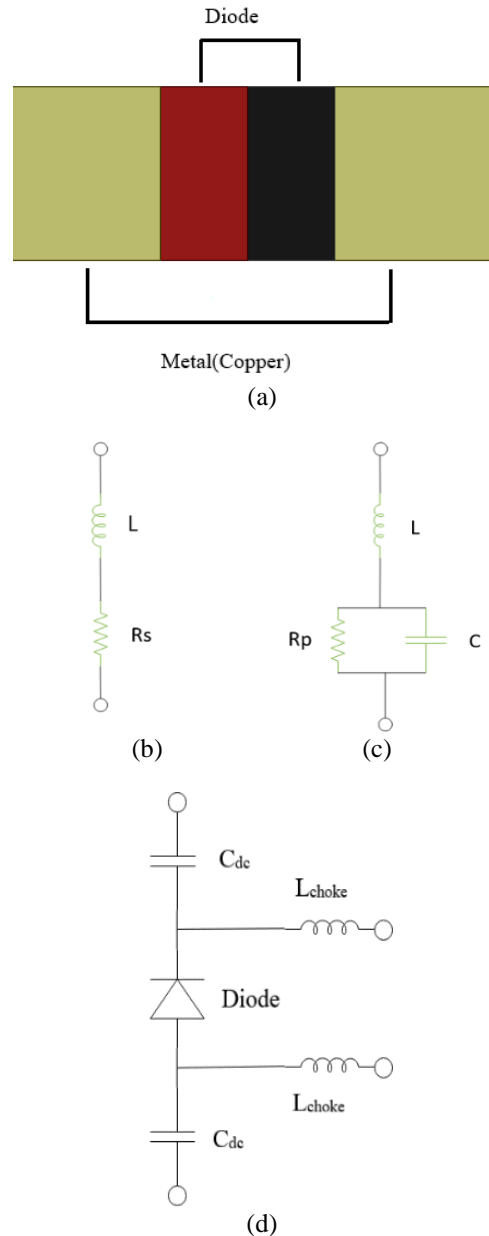

Figure. 4 The electrical model of the RF PIN diode: (a) HFSS model, (b) equivalent circuit under “ON” condition, (c) “OFF” condition, and (d) DC blocking capacitor and RF choke biasing circuit

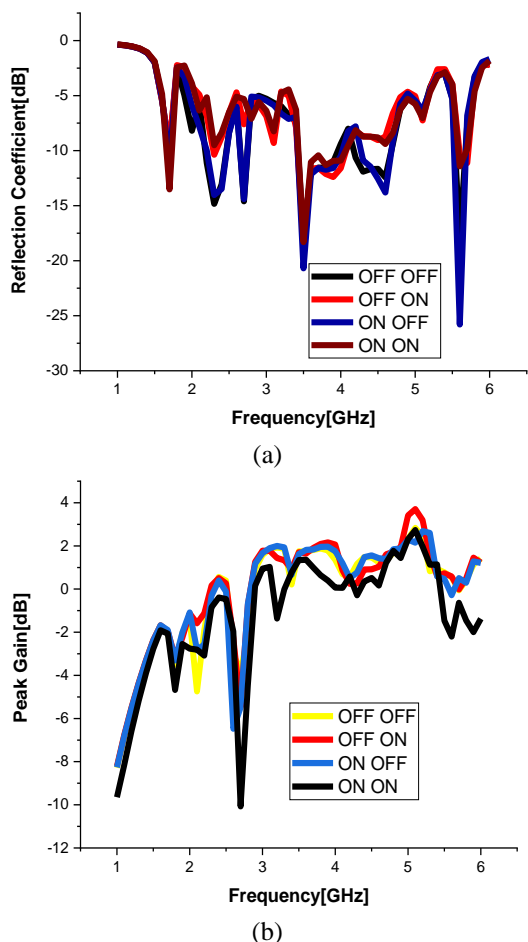

Figure. 5 Simulated results on reconfiguration conditions: (a) reflection coefficient and (b) peak gain

4. Frequency reconfigurability:

To switch the proposed multiband antenna at a different frequency by using a PIN diode is introduced in the backside of the antenna. The Diode model used in the proposed antenna is BAR64-03W5627.

The Equivalent circuit diagrams of the PIN diode in “ON” state and “OFF” state is shown in the figure. The values of the inductance, capacitance and resistance of the pin diode are $R_s = 0.85\Omega$, $R_p = 3K\Omega$, $C = 0.17pF$, $L = 1.7nH$. The DC blocking capacitor is introduced in the slots between the grounds to provide isolation between DC Bias voltage and Radio Frequency Signal. The inclusion of RF Choke circuit as shown in the figure having value $L_{choke} = 6.8nH$ and $C_{dc} = 100 pF$ which are used to block RF signal and allow DC current to pass through.

Four iterations have been taken and analysed. In case 1 i.e., at D1 OFF and D2 off and D1 OFF and D2 ON the notch band is occurred at the WiMAX band and at the other conditions D1 ON and D2

OFF and D1 ON D2 ON the notch shifted to the 2.4GHz band.

Figs. 6 and 7 shows the E-field distribution and current distribution of the proposed antenna. The E-field propagation is differentiating with the etching of complimentary split ring resonator on the ground. The concentration of current vectors in the ground are affected by metamaterial inspired complimentary split ring resonator. The radiation patterns with respect to XY-plane and YZ-plane and ZX-plane are observed in the Fig. 8. The patterns of different conditions of the two diodes are been noted. The current model has been compared with existing literature.

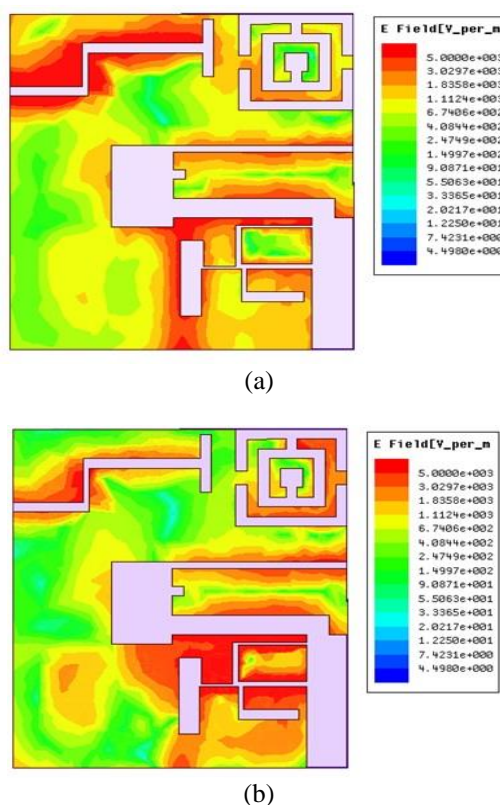

Figure. 6 Simulated results E-field distribution at: (a) 1.6GHz and (b) 2.2GHz

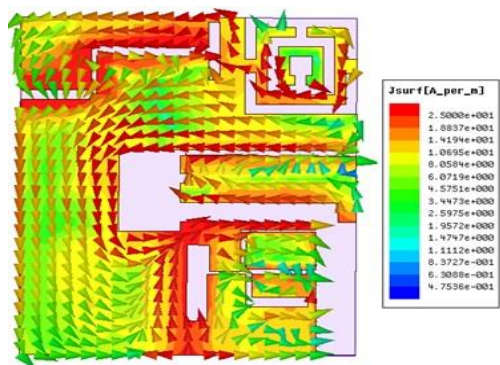

Figure. 7 Simulated results current distribution of ground at 1.6 GHz

Table 3. Comparison with the literature

Ref no	Total Area (mm ²)	No. of Bands	Operating bands	Gain(dBi) at the operating bands	Reconfigurability
[6]	55x50	3	2.54/3.55/5.7	5.71/6.16/6.48	No
[7]	40x40	4	3.04/3.83/4.83/5.76	2.36/1.43/2.11/2.39	No
[8]	38x38	3	2.4/3.5/5.8	1.52/1.6/1.5	No
[9]	56x44	4	3.1/5.52/7.31/9.72	1.35/1.0/1.07/1.75	No
[10]	40x50	2	3.5/5.2	2.84/0.16	No
[11]	28x30	4	1.6/2.5/5.8/9.5	2.9/2.4/3.1/1.8	Yes
[12]	32x32	5	3.5/5.9/6.7/8.5/9.8	1.2/1.6/2.1/2.5/2.7	No
Proposed Antenna	35x30	6	2.3/2.7/3.5/3.8/4.3/5.6	2.2/2.5/3.4/3.2/3.5/4	Yes

4.1 Radiation patterns

The designed model is compared with the latest literature and presented it in the Table 3.

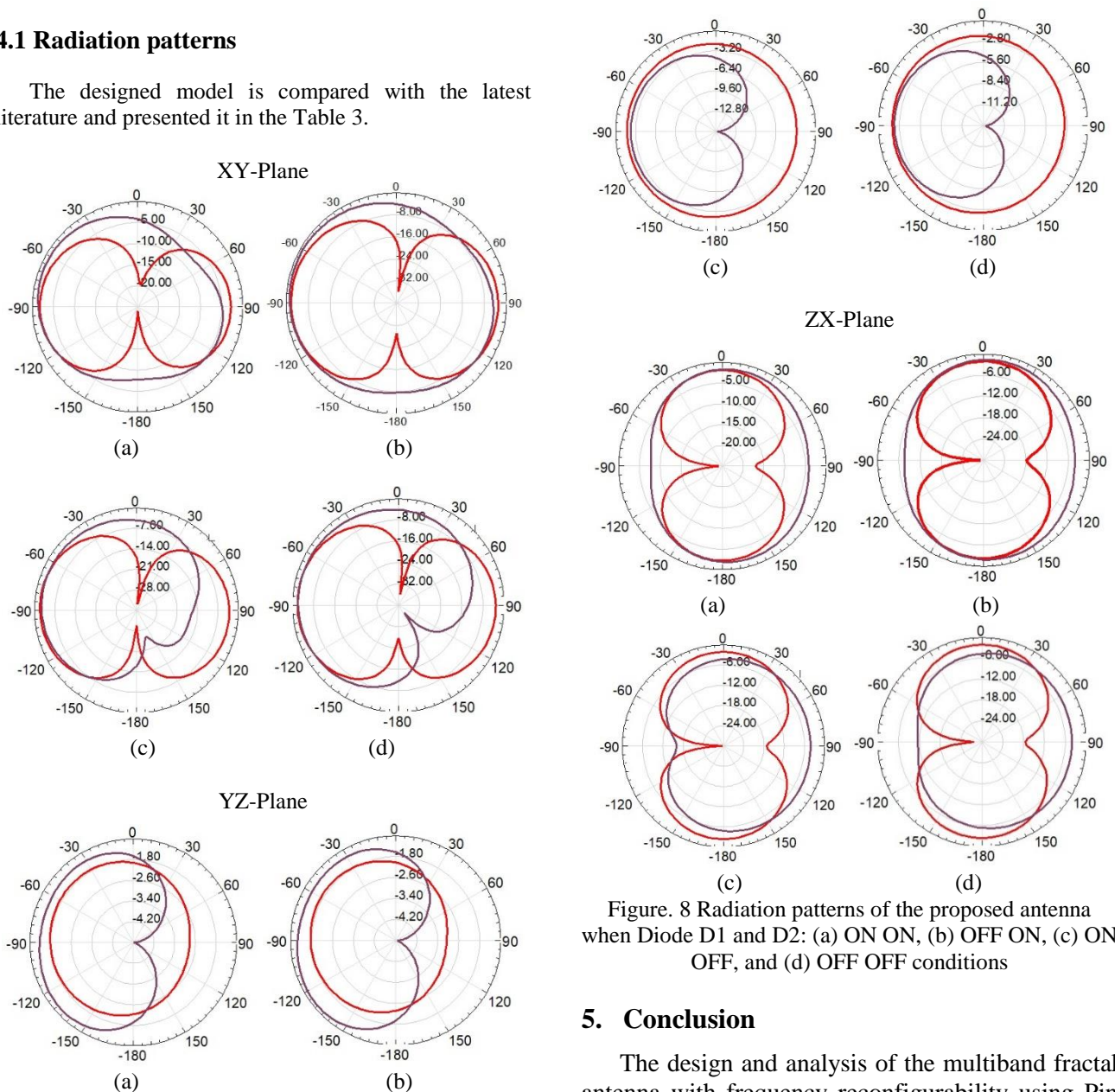

Figure. 8 Radiation patterns of the proposed antenna when Diode D1 and D2: (a) ON ON, (b) OFF ON, (c) ON OFF, and (d) OFF OFF conditions

5. Conclusion

The design and analysis of the multiband fractal antenna with frequency reconfigurability using Pin diode has been analysed in this article. The performance of the antenna with diodes at different cases and without diodes are analysed and compared

using ANSYS EM software. The proposed antenna exhibiting stable radiation at multiband and acceptable gain with overall radiation efficiency of 85 percent. The measured results also illustrate good correlation with the simulated results which projects. The designed antenna is a good candidate for the applications such as GPS (1.6GHz), Bluetooth (2.4GHz) WiMAX (5.7GHz). In respect to that, the frequency reconfigurability using two diodes and the switchable characteristics of the designed antenna are tested in two conditions such as ON condition the switching characteristics are seen in the lower bands such as 1.8GHz having bandwidth of 18% and WiMAX 3.5GHz band with a bandwidth of 20%. In case of OFF condition the lower frequency band of GPS is converted as the notch band and increase of about 20% B.W has been observed in Bluetooth 2.4GHz and 5.6 UPPER WiMAX bands. That the proposed antenna is a good candidature for the wireless applications.

Acknowledgments

We are thankful to KLEF for their moral support and DST for their technical support through ECR/2016/000569 and EEQ/2016/000604

References

- [1] L. I. Basilio, L. K. Warne, W. L. Langston, W. A. Johnson, and M. B. Sinclair, "Microwave-frequency, negative-index metamaterial designs based on degenerate dielectric resonators", *IEEE Antennas and Wireless Propagation Letters*, Vol.11, pp. 113-116, 2009.
- [2] A. R. Katko and A. M. Hawkes, "Rf limiter metamaterial using pin diodes", *IEEE Antennas and Wireless Propagation Letters*, Vol.10, pp.1571-1574, 2011.
- [3] R. K. Singh, A. Basu, and S. K. Koul, "A Novel Reconfigurable Microstrip Patch Antenna with Polarization Agility in Two Switchable Frequency Bands", *IEEE Transactions on Antennas and Propagation*, Vol. 66, No.10, pp. 5608-5613, 2018.
- [4] Md. Asaduzzaman, I. Bahceci, S. Blanch, J. Romeu, L. Jofre, and B. A. Cetiner, "A reconfigurable antenna with beam steering and beam width variability for wireless communications", *IEEE Transactions on Antennas and Propagation*, Vol.66, No.10, pp. 5052-5063, 2018.
- [5] B. T. P. Madhav and H. Kaza, "Design and Analysis of Compact Coplanar Wave Guide Fed Asymmetric Monopole Antennas", *Research Journal of Applied Sciences Engineering and Technology*, Vol.10, pp. 247-252, 2015.
- [6] Md. Rezwatul, M. T. Islam, and M. Habibullah, "Computational and experimental analysis of high gain antenna for WLAN/WiMAX applications", *Journal of Computational Electronics*, Vol.14, No.2, pp. 634-641, 2015.
- [7] P. Syam Sundar, K. Sarat, and T. V. Ramakrishna, "Novel Miniatured Wide Band Annular Slot Monopole Antenna", *Far East Journal of Electronics and Communications*, Vol.14, pp. 149-159, 2015.
- [8] R. K. Saraswat, and M. Kumar, "Miniaturized slotted ground UWB antenna loaded with metamaterial for WLAN and WiMAX applications", *Progress in Electromagnetics Research*. Vol.65, pp. 65-80, 2016.
- [9] A. Tanweer, M. Saadh, and R. C. Biradar, "A fractal quad-band antenna loaded with L-shaped slot and metamaterial for wireless applications", *International Journal of Microwave and Wireless Technologies*, Vol.10, No.7, pp. 826-834, 2018.
- [10] T. Hung, J. Liu, and C. Wei, "Dual-band circularly polarized aperture-coupled stack antenna with fractal patch for WLAN and WiMAX applications", *International Journal of RF and Microwave Computer-Aided Engineering*, Vol.24, No.1, pp. 130-138, 2014.
- [11] A. Tanweer, M. Muzammil, and R. C. Biradar, "A multiband reconfigurable slot antenna for wireless applications", *AEU-International Journal of Electronics and Communications*, Vol. 84, pp. 273-280, 2018.
- [12] A. Tanweer, K. D. Prasad, and R. C. Biradar. "A miniaturized slotted multiband antenna for wireless applications", *Journal of Computational Electronics*, Vol.17, No.3, pp. 1-15, 2018.
- [13] M. Kosuru, K. Umakantham, and K. Satyanarayana, "Reconfigurable Notch Band Monopole Slot Antenna for WLAN/IEEE-802.11n Applications", *International Journal of Intelligent Engineering and Systems*, Vol.10, No.6, pp. 166-173, 2017.
- [14] B. T. P. Madhav and M. P. Kishore, "Bandwidth Enhancement of CPW-Fed Elliptical Curved Antenna with Square SRR", *International Journal of Intelligent Engineering and Systems*, Vol.11, No.2, pp. 68-75, 2018.
- [15] M. V. Rao, B. T. P. Madhav, T. Anilkumar, and B. P. Nadh. "Metamaterial inspired quad band circularly polarized antenna for WLAN/ISM/Bluetooth/WiMAX and satellite communication applications", *AEU-International Journal of Intelligent Engineering and Systems*, Vol.12, No.2, 2019

International Journal of Electronics and Communications, Vol.97, pp. 229-241, 2018.