

Using graphical organizers in the teaching process of ICT

Asiya Ibragimovna Tureniyazova*

Ph.D Professor, Polytechnic Institute of Guarda, CI&DEI - Centre for Studies in Education and Innovation

Email: brigas@ipg.pt

*Corresponding Author: *brigas@ipg.pt*

Received :16.07.2019

Revision Requested: :06.09.2019

Accepted :----- :18.09.2019

How to cite this paper: Tureniyazova, A. I. (2019). Using graphical organizers in the teaching process of ICT. *Research in Social Sciences and Technology, 4(2)* 31-40

Abstract

To date, hundreds of advanced teaching methods, such as game methods, have been developed, and these problem-based learning methods are widely used in education. Most of these technologies are based on the principles of student-centered and participatory learning. These interactive methods allow the learner to master the necessary professional knowledge, skills, and competencies under the managerial guidance of a teacher. On the other hand, students should be familiar with how to work with information using modern means of obtaining information to collect, analyze, and apply facts to solve problems. This implies an important task facing educational institutions: the integration of information technology in the educational process. In this article, the author shares her experience of using graphic organizers and IT for effectivity of the teaching process due to visibility, high involvement of students, and their active learning and creativity.

The graphic organizers as supportive tools for teaching and learning and their use and types are described. Examples of graphic organizers for teaching/learning IT and Information Security, designed using IT, are given.

Keywords: ICT, Learning, Teaching, Graphic organizer/s (GO/s), Mindmap

Introduction

International studies have identified a teacher's professional identity as one of the most important factors to achieving educational improvement (García-Martínez & Tadeu, 2018). According to this, we seek to improve the education of professional teachers, who have solid knowledge and should be able to apply this knowledge in solving various problems of everyday life, using different approaches related to tasks of modern education with their students. Students' motivation, interests, and involvement in learning activities have a large role in ensuring the successful implementation of this task by teachers. An experienced teacher should skillfully use effective methods and means to successfully achieve the planned learning outcomes. These methods are well known, but not every teacher, unfortunately, uses them

correctly or for their intended purpose. Very often the choice of methods and means of learning is random, not justified in accordance with the objectives of the lesson; their use is formal and therefore unsuccessful. At the same time, the competent use of methods with a clearly defined role in the general concept of the lesson makes the lesson a fascinating event of involvement and teachers co-working with students, giving to both sides a high degree of satisfaction with the progress achieved (Etherington, 2019).

Importance of integration of IT into the educational process

Times are changing, and a student is “no longer the same introverted child that studied in the workbench of fifteen or twenty years ago;” indeed, we live in a time of “smartphones, tablets, and a wide range of portable technologies at our disposal” (Tadeu & Brigas, 2018, p. 103), so education, and more specifically the learning and teaching process, should address the necessary means to handle the evolution of ICT.

Computerization of education is designed to improve the quality of education through a fuller use of available information, increase the effectiveness of the educational process based on its individualization and intensification, develop effective methods and technologies for developing education, and integrate various types of activities (educational, research, methodological, scientific, organizational) in the framework of a single methodology based on information technology, preparing graduates for life in the conditions of information society, increasing their professional competence and competitiveness (Tureniyazova, 2013).

ICT has the potential to bring real-life issues into classrooms in a way that was not possible before in a traditional classroom setting. The flexible nature of ICT and the Internet especially provide pupils (and others) with the opportunities for research, interaction, cooperation, and collaboration (Baytak, et al. ,2011; Cole, 2000).

Computer technology is a powerful way to increase the effectiveness of the educational process because the computerization of the learning process makes it possible to work individually with each student according to tasks specially developed for them. This imposes additional tasks on the teacher to improve the educational methods used, to develop new forms and methods of organizing the educational process, providing optimal conditions for self-development and self-education of pupils and students.

In this article, it is our intention to show how such participatory means of teaching and learning as graphic organizers, designed by using ICT, could be a very useful tool for motivation, involvement, individualization, visualization, creativity, and effectivity of teaching.

Graphic organizers as tools for visual thinking and organizing information

To raise a generation that is able to think critically, make decisions quickly, and find a way out in critical life situations, it is important to equip students with learning methods and tools for

independent, active learning rather than giving them ready material for memorization (Tureniyazova, 2018). This pedagogical task requires the effective learning technologies which bring up in the learner the ability to analyze the received (from teacher, from textbook, from Internet) educational information, to extract from the total amount of information the necessary, reliable piece, to teach how to use the information found for solving specific problems.

According to Allan Paivio's theory of dual coding, humans process information in both visual and verbal forms. When we are learning new words or concepts, it is helpful to try to form mental images for those ideas to reinforce their meanings (Paivio, 1986).

Visual thinking is a learning style in which the learner better understands and retains information when ideas, words, and concepts are associated with images. Research tells us that the majority of students in a regular classroom need to see information in order to learn it. A graphic organizer is a visual display that demonstrates relationships between facts, concepts, or ideas (Inspiration, Webgraphy). Graphic organizers are communication tools that show the organization or structure of concepts as well as relationships between concepts.

They help:

- to extract the important, essential information and give an overview of a large subject;
- to show the structure of concepts, their hierarchy;
- to compare and show relationships and contrasts between concepts;
- to sort and range, to show cause and effect, etc.

Graphic organizers facilitate the assimilation of textual information by its visual presentation. They allow you to penetrate deep into the essence of the concepts, analyze and see the internal relationships, and show the logical sequence of processes, as well as build an algorithm for solving the problem. With their help, one can develop a creative imagination, build various associations, and generate original ideas. One can display a large amount of information in a concise, visual form on one page, making it easier to remember.

There are many types of graphical organizers, of which some are good for ranging and sequencing, some make comparison easy, and some are better to use for showing cause and effect.

An example of a graphic organizer is a Cluster explaining a graphic organizer's concept, as below:

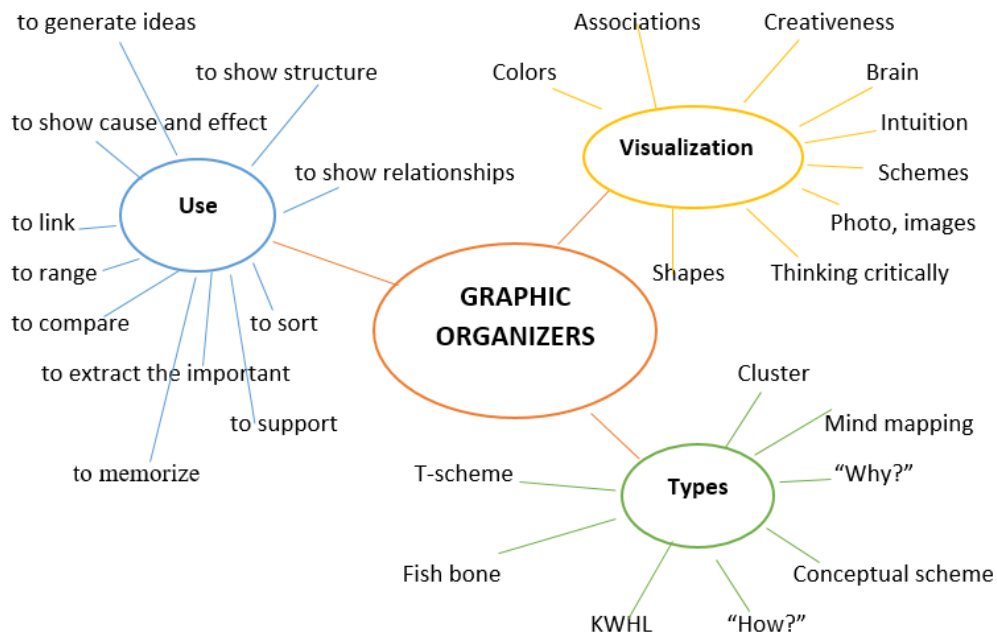

Figure 1. Cluster, "Graphic Organizers."

Many educational institutions worldwide have incorporated the use of clickers and other student response systems such as iPods, laptops, tablets, and smartphones inside classrooms, to make sure they are not left behind as the Net Generation (Oblinger & Oblinger, 2005; Tarman, 2009, 2010). We can use students' interest in computers and different types of portable devices (tablets, smartphones, etc.) to make learning "boring" material more fascinating and exciting through the absorbing activity of drawing graphic organizers and searching information for making GOs more contentful and unique. GOs can be drawn in a very simple graphic editor, Microsoft Paint. Teachers and students can also use ready shapes of the Smart Art tool of MS Word for presenting different structures and relations, or Seesaw, Power Point, or Google Slides (Tureniyazova, 2018).

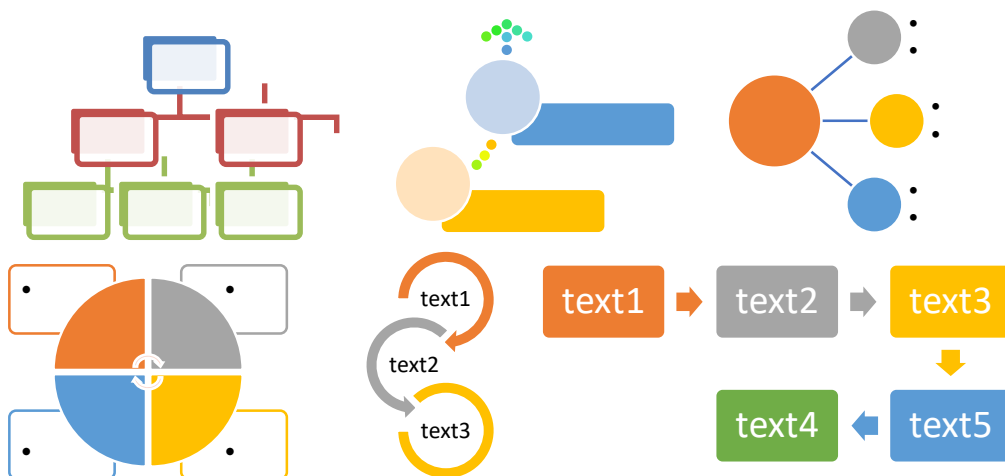

Figure 2. Smart Art tools of MS Word for drawing graphic organizers.

A mind map is a mainly hierarchical diagram used to organize information, ideas, and understanding of a topic. It is a type of diagram that can aid visual thinking, learning, planning, and creativity (MindMapping, Webgraphy), a diagram for representing tasks, words, concepts, or items linked to and arranged around a central concept or subject. It uses a non-linear graphical layout that allows the user to build an intuitive framework around a central concept. A mind map can turn long lists of monotonous information into a colorful, memorable, and highly organized diagram that works with the brain's natural way of doing things. Mind maps help us remember information, as they hold it in a format that the mind finds easy to recall and quick to review.

The use of graphic organizers showed their high efficiency in my experience in teaching disciplines of a specialty for first-year students of the bachelor's degree in "Methods of Teaching Informatics" at the Nukus State Pedagogical Institute. Students are very willing to accept the offer to design graphic organizers using computer devices. They are especially encouraged by the possibility of using smartphones, the use of which is not allowed on the campus of the institute, and Internet access. In the actualizing phase with the help of organizers such as KWHL, Cluster, How?, etc., the basic knowledge of students on the topic is discovered. Then they are shared in lecture texts via SHAREit, and they could also find materials on the Internet to fill out the proposed GOs. The role of the teacher is only to facilitate the process, and the students, each individually, bring their work "to perfection." Everyone tries to make their "drawing" bright, original, meaningful. Nobody is cheating, no copying! Students are very creative in using multi-colored forms, lines, making combinations of different GOs, inventing new ones. For example, at the end of December, a student rotated a GO Fish Skeleton, making it a Christmas tree, and decorated it with different toys with texts on the topic. Work on the initiated GOs is to be completed at home, and sometimes it is continued in the next classes on the basis of additional material on the topic. Finished work is accepted as one completed task for independent work.

Examples of using IT and graphic organizers in teaching and learning IT

In this section, we would like to show how graphic organizers could be drawn using a computer, and how learning ICT concepts such as a scheme for comparing computer viruses and biological viruses could easily be drawn in MS Word. The importance of visualizing concepts is showed by the following examples and structures that state directly the connections and interconnections between the several elements in the study. By doing this, students learn the links and networks of the process in a much easier way.

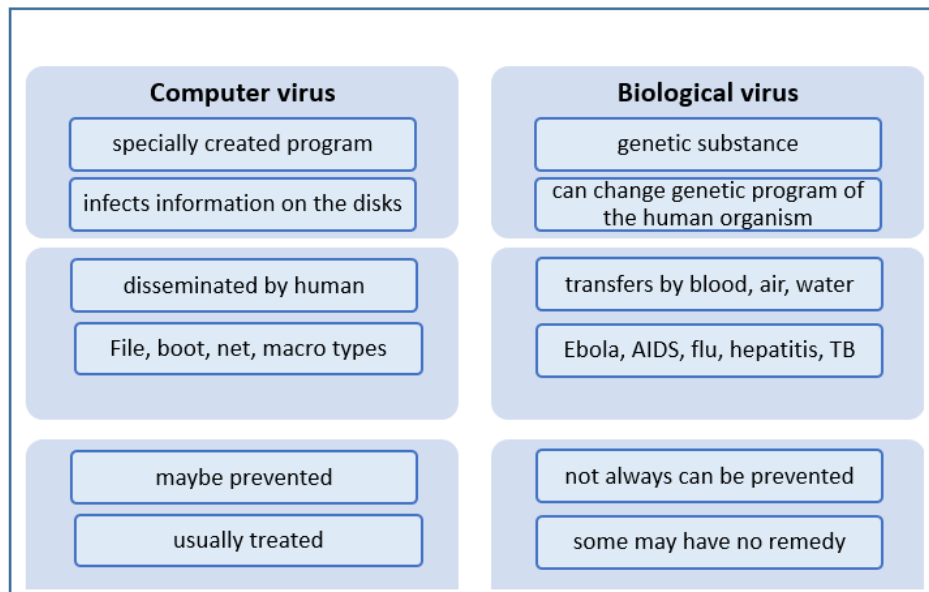

Figure 3. Graphic organizer T-scheme for comparing computer viruses and biological viruses. Using a Cluster GO in the process of teaching the subject of Information Security could be done by drawing shapes in MS Word, as in the following example:

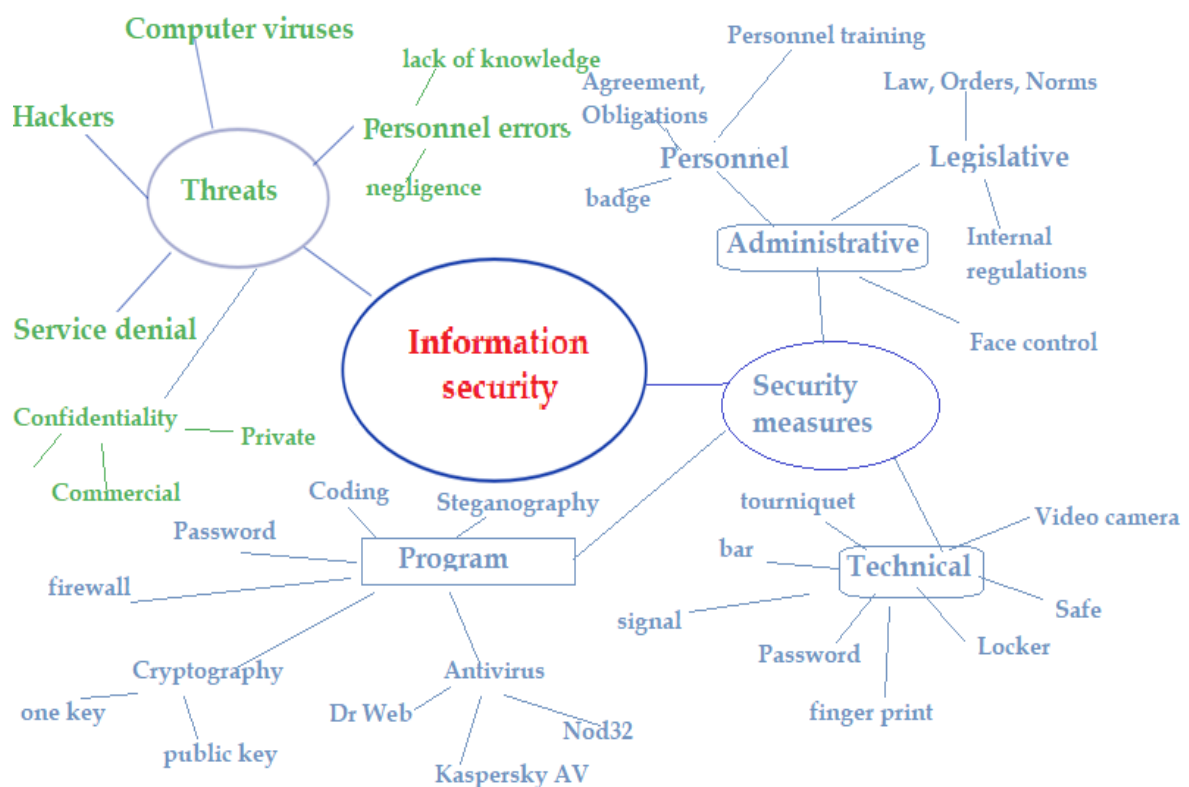

Figure 4. Graphic organizer Cluster for "Information Security" concept.

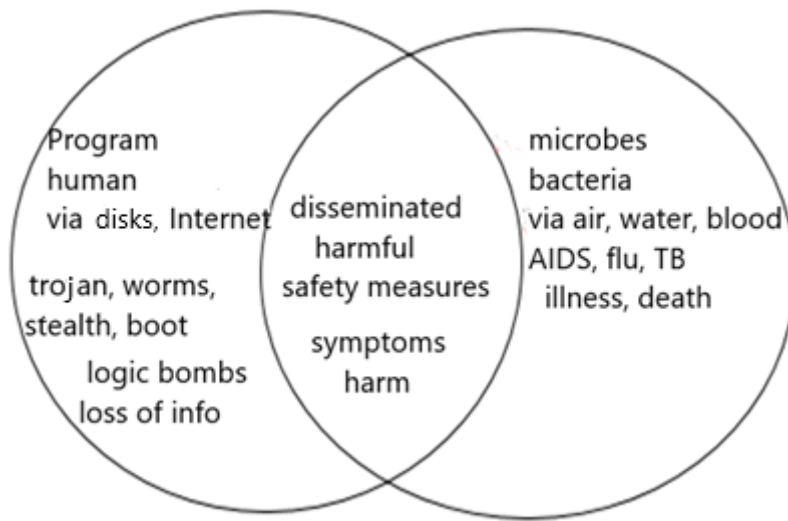

Figure 5. Graphic organizer Venn diagram for identifying similarities and contrasts between computer viruses and biological viruses.

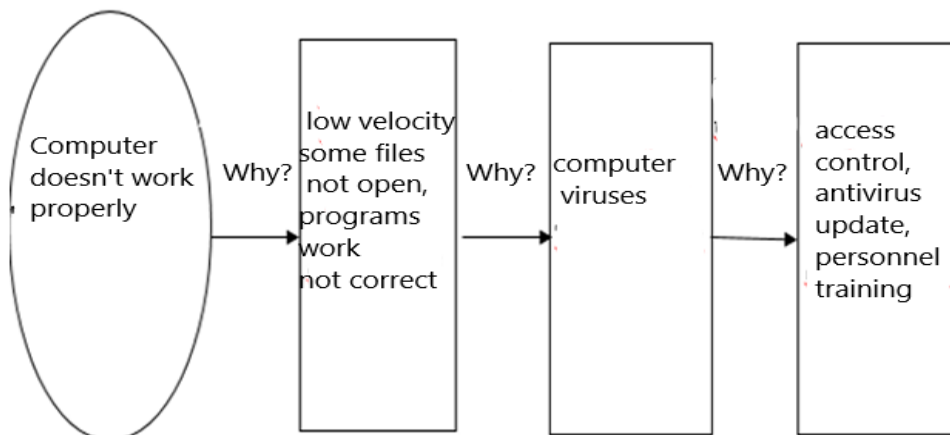

Figure 6. Graphic organizer "Why?" for analyzing why the computer doesn't work correctly.

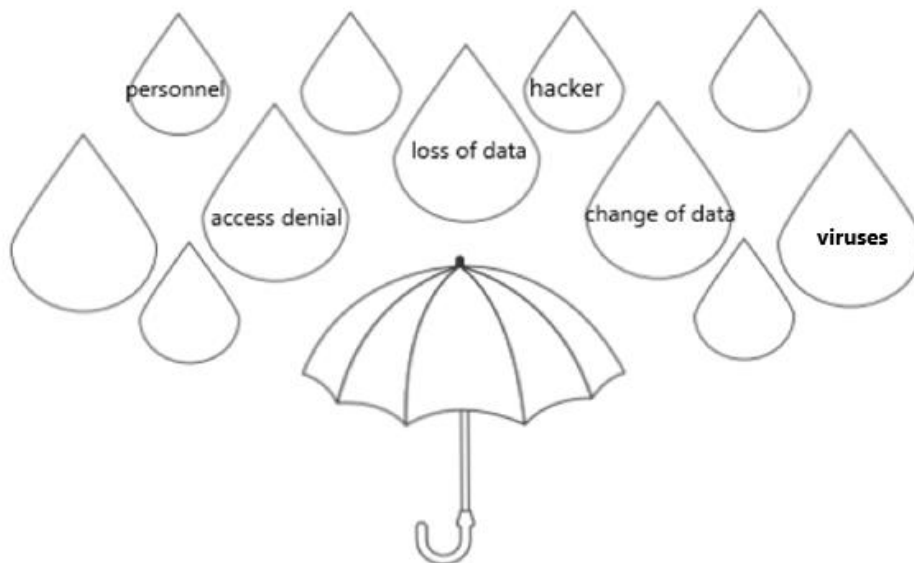

Figure 7. "Threats to information" Brain Droplets.

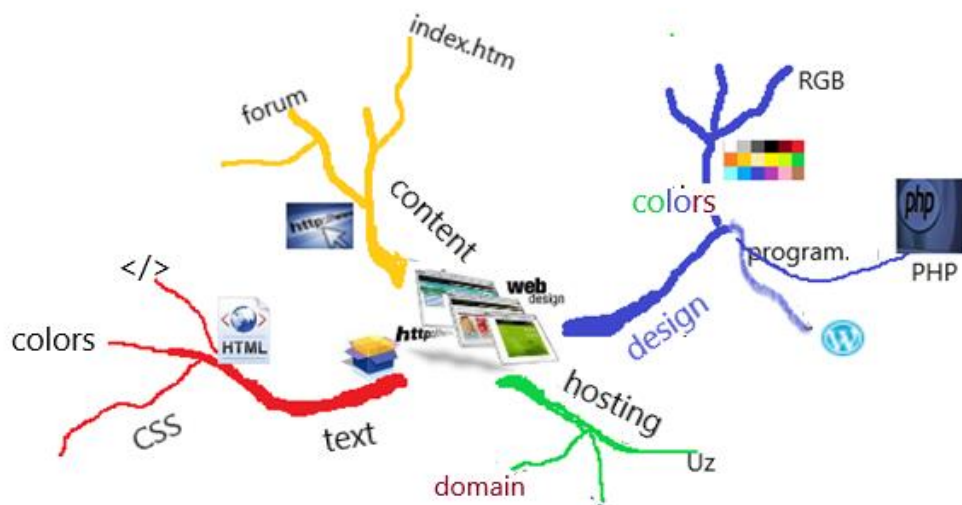

Figure 8. Web design presented in Mind Mapping technique (Tureniyazova, 2018).

A timeline of important events with comments and images on dates, the visual construction of the causal relationships of events and processes, deep insight into the essence of objects by drawing their internal structure and composition, a comparative diagram of two or more similar phenomena, and many other graphical organizers, creative and meaningful, facilitate the individual perception and understanding of the concepts being studied (Tureniyazova, 2013). The examples presented here assume a natural position inside of the modern classroom; they can be used due to their easy understandability and the simplicity of connections because they allow students to create powerful mental connections using the knowledge that they possess already and the new data that they are collecting.

The entrepreneurial spirit needs to be addressed inside the classroom; students and teachers need to adapt to new realities. Across the world, we found several examples of the need to develop new and different attitudes facing the learning and teaching process: For instance, in the Entrepreneurship 2020 Action Plan from the European Commission, it is stated that the world needs more entrepreneurs, and for that, ICT tools could help to bring the necessary and effective change.

Conclusion

To meet the requirements of a quickly changing world and labor market, our graduates must have strong knowledge, skills, and competencies, be able to think critically, be flexible, and be able to analyze the situation and make decisions. To train such personnel, effective educational technologies are needed. Learning and teaching processes should develop entrepreneurial capabilities like creativity and auto/self-confidence (Paiva & Tadeu, 2017), because attitudes of entrepreneurship education help students to be more innovative in their lives.

It has been proven that the use of information technologies improves the quality of training, but experience shows that, used with other techniques, they give an even greater effect. Presenting information in both text and graphic formats is one of the most basic ways to make a lesson accessible to more students. Visibility is one of the main didactic principles for increasing learning efficiency. The use of ICT makes it possible to provide this visibility, and good examples of the use of ICT in education and self-education are computer-generated organizers. Graphic organizers could be a very effective tool of teaching and learning for students of different ages and abilities. They can be used by teachers for presenting new material, for reviewing and testing the students' knowledge, and for homework or independent study. In the graphic organizers drawn on the computer, one can make changes in the course of mental activity without fear of "spoiling the picture" like in the case of drawing on paper, and that makes students feel free, confident, active, and creative in learning.

To conclude, the use of graphic organizers and ICT in combination allow for making the learning process easy, interesting, and understandable for students, and that is why it is effective.

References

- Baytak, A., Tarman, B., & Ayas, C. (2011). Experiencing technology integration in education: Children's perceptions. *International Electronic Journal of Elementary Education*, 3(2), 139-151.
- Cole, R. (Ed.). (2000). *Issues in web-based pedagogy*. London: Greenwood Press.
- Etherington, M. (2019). The Challenge with Educational Transformation. *Journal of Culture and Values in Education*, 2(1), 96-112. Retrieved from <http://cultureandvalues.org/index.php/JCV/article/view/33>

- García-Martínez, I., & Tadeu, P. (2018). The influence of pedagogical leadership on the construction of professional identity. *Systematic review, Journal of Social Studies Education Research (JSSER)*, DOI: 10.17499/jsser.90982
- Oblinger, D., & Oblinger, J. (2005). Is it age or IT: First steps toward understanding the net generation. *Educating the Net Generation*, 2(1-2), 20. Retrieved February 28, 2018, from <https://digitalcommons.brockport.edu/bookshelf/272>
- Paiva, T., & Tadeu, P. (2017). New approach to entrepreneurship education in primary schools: The BGENTL. *Turkish Online Journal of Educational Technology (TOJET)*, <http://hdl.handle.net/10314/3911>
- Paivio, A. (1986). *Mental representations: A dual coding approach*. Oxford, England: Oxford University Press.
- Tadeu, P., & Brigas, C. (2018). Using online programs to centre students in the twenty-first century. In C. Fitzgerald, S. Laurian-Fitzgerald, & C. Popa (Eds.), *Handbook of Research on Student-Centered Strategies in Online Adult Learning Environments* (pp. 102-119). Hershey, PA: IGI Global. doi:10.4018/978-1-5225-5085-3.ch005
- Tarman, B. (2009). *The digital divide in education*. ERIC (ED508213)
- Tarman, B. (2010). Global perspectives and challenges on teacher education in Turkey. *International Journal of Arts & Sciences (IJAS)*, 3(17), 78-96.
- Turenliyazova, A. (2013). Возможности использования информационных технологий в образовании. Муфаллим ҳам узликсиз билимлендириў. *Scientific-Methodical Journal*, 2013, №4.
- Turenliyazova, A. (2013). Informatikaning asosiy tushunchalarini o'rgatishda grafikli organayzerlardan foydalanish. *Physics, Mathematics and Informatics, Scientific-Methodical Journal*, №6. Tashkent.
- Turenliyazova, A. (2018). *Informatikani oqitiwdin formalari, metodlari ham qurallari*. T.: "Fan va texnologiyalar."
- Webgraphy (retrieved 03/04/2019)
<http://www.inspiration.com/visual-learning/graphic-organizers>
<http://www.mind-mapping.org/mindmapping-and-you/Knol-on-mind-mapping.html>
<http://www.mindmapping.com/mind-map.php>
<http://ec.europa.eu/growth/smes/promoting-entrepreneurship/action-plan/>