



**Article citation information:**

Homišín, J. Optimal tuning of mechanical systems by application of a pneumatic tuner of torsional oscillation. *Scientific Journal of Silesian University of Technology. Series Transport*. 2017, **97**, 47-55. ISSN: 0209-3324. DOI: <https://doi.org/10.20858/sjsutst.2017.97.5>.

**Jaroslav HOMIŠÍN<sup>1</sup>**

## OPTIMAL TUNING OF MECHANICAL SYSTEMS BY APPLICATION OF A PNEUMATIC TUNER OF TORSIONAL OSCILLATION

**Summary.** Reducing the dynamic load of any mechanical system can be achieved when the torsional vibration magnitude is optimized by applying a pneumatic tuner of torsional oscillation. Changing the torsional stiffness of a pneumatic tuner can be accomplished by changing the pressure of the gaseous medium, out of operation or during the operation of a mechanical system. This results in two suggested methods of tuning: (i) tuning of torsional oscillating mechanical systems that are out of operation, which fulfils the conditions for mechanical system tuning; (2) tuning mechanical systems during an operation in a steady state, thus ensuring the conditions of so-called continuous tuning of the given systems. The aim of this paper is to present the possibility of controlling torsional oscillation of a mechanical system that is out of operation by applying a tangential pneumatic tuner of torsional oscillation.

**Keywords:** mechanical system; torsional vibration of mechanical systems; pneumatic tuner of torsional oscillation; tuning of mechanical system

### 1. INTRODUCTION

Reducing the dynamic load of individual parts of any mechanical system is achieved by optimal tuning, i.e., optimizing the system in terms of the magnitude of torsional oscillation.

---

<sup>1</sup> Technical University of Košice, Faculty of Mechanical Engineering, Department of Design, Automotive and Transport Engineering, Letná 9, 040 01 Košice, Slovakia. Email: [jaroslav.homisin@tuke.sk](mailto:jaroslav.homisin@tuke.sk).

The most preferred member for tuning any mechanical system in advance is a suitably adapted pneumatic tuner of torsional oscillation. In our department, among others, we have been engaged in the development and research of pneumatic tuners of torsional oscillation for a long time. In particular, we focus on the possibilities of applying the given tuners of torsional oscillating mechanical systems with the intention to optimize them in terms of minimizing or eliminating dangerous torsional vibrations.

The aim of this paper is to present the possibility of controlling the torsional oscillation of mechanical systems that are *out of operation* by applying a *tangential pneumatic tuner of torsional oscillation*.

## 2. BRIEF CHARACTERISTICS OF PNEUMATIC TUNERS OF TORSIONAL OSCILLATION

### 2.1. Tangential pneumatic tuner of torsional oscillation

Tangential pneumatic tuning of torsional oscillation (Fig. 1a-b) consists of a driving (1) and a driven part (2) between which a compression space is located. The compression space is formed by circumferentially and tangentially spaced pneumatic-flexible elements (3). The pneumatic-flexible elements are characterized by a rubber cord single-bellow (Fig. 1a-b) air spring filled with gaseous medium. In the case of the load torque transmission, two pneumatic-flexible elements are compressed and two are expanded simultaneously, thereby ensuring the design of a two-sided pneumatic tuner. By means of the valve (4), the compression space of the pneumatic tuner is filled with gaseous medium in the range  $p=100\div 700$  kPa. The design of the pneumatic tuner allows the individual pneumatic-flexible elements to be interconnected by means of replaceable throttling nozzles (5) and hoses (6). To illustrate and present the basic characteristics of pneumatic tuners of torsional oscillation, we only present the course of static characteristics in general. From the obtained results of static measurements, it has been shown that, by changing the pressure of the gaseous medium, a pneumatic tuner is able to work with different characteristic (Fig. 2); thus, it is capable of working with other characteristic properties (torsional stiffness and damping coefficient).

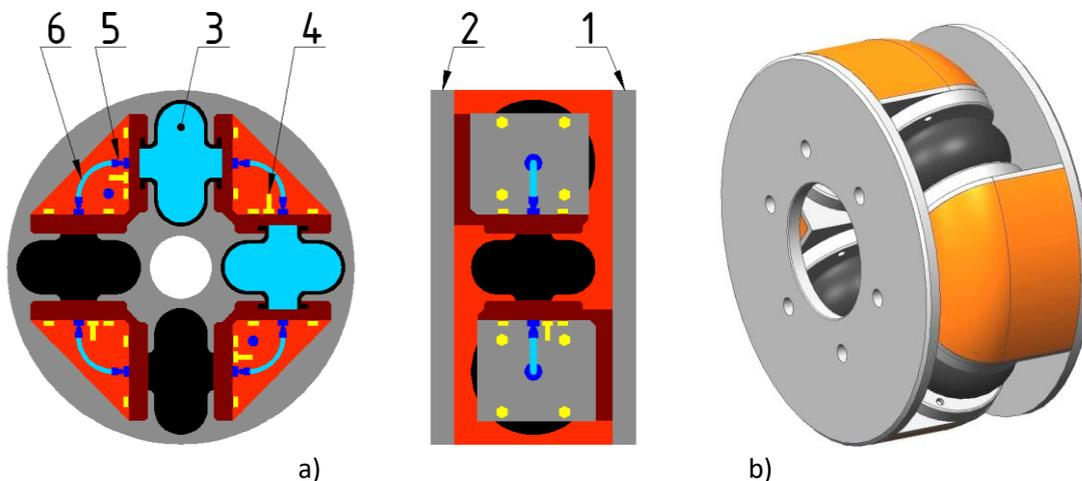

Fig. 1. Tangential pneumatic tuner of torsional oscillation type 4/1-T-C (a, b)

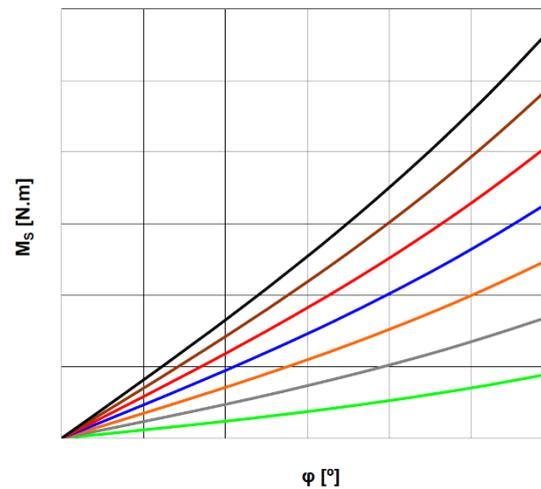

Fig. 2. Static characteristics of pneumatic tuners of torsional oscillation in the pressure range  $p=100\div 700$  kPa

Based on Fig. 2, it can be stated that the characteristics of the pneumatic tuners are slightly non-linear. We express them with the following equation:

$$M_s = a_1 \cdot \varphi + a_3 \cdot \varphi^3. \quad (1)$$

### 3. TUNING METHODS FOR TORSIONAL OSCILLATING MECHANICAL SYSTEMS

Changing the torsional stiffness of pneumatic tuners can be accomplished by changing the pressure of the gaseous medium, when out of operation or during the operation of the mechanical systems. This results in two suggested methods of tuning:

- Tuning of torsional oscillating mechanical systems that are out of operation, which fulfils the condition of the given mechanical system tuning
- Tuning mechanical systems during an operation in a steady state, thus ensuring the condition of the so-called continuous tuning of the given systems.

By tuning the torsional oscillating mechanical system with a pneumatic coupling, when out of operation, we mean to inflate the compression space of the pneumatic tuner to the appropriate pressure value of the gaseous medium before launching the system. At a given pressure, the mechanical system will work throughout its operation. The appropriate value of the pressure of the gaseous medium and thus the appropriate value of the dynamic torsional stiffness of the coupling are determined on the basis of the dynamic calculation of the system in terms of torsional dynamics.

The suggested method of mechanical systems tuning can be characterized as the “tuning of torsional oscillating mechanical systems”, which is only suitable for systems working at constant operating speeds.

When investigating the proper tuning of any torsional oscillating mechanical system operating at constant operating speeds, we start with the Campbell diagram (Fig. 6), which shows the positions of critical speed  $n_K$  (or the position of the critical angular speeds  $\omega_K$ ) depending on the natural speed frequencies  $N$  (or its natural angular frequencies  $\Omega_0$ ).

#### 4. CHARACTERISTICS OF THE TORSIONAL OSCILLATING MECHANICAL SYSTEM

The torsional oscillating mechanical system (Fig. 3) consists of a driving part (1), a pneumatic tuner of torsional oscillation (3) and a driven part (2). The driving part consists of a 16-kW direct current electric motor and an additional thyristor speed regulator (4) with the possibility of speed control in the range  $n=0\div 2,000\text{ min}^{-1}$ . A pneumatic tuner is used to drive an exciter of torsional oscillation, represented by a three-cylinder compressor mounted on the insulated layer (5). In order to increase the torsional impact introduced by the compressor into the mechanical system, we use a compressor without a flywheel. The load of the torsional oscillating mechanical system from the compressor will be regulated by a throttle valve (6) built into the outlet pipe of the compressor. This means that the load of the system will be controlled and its load value will be characterized by the pressure in the outlet pipe ( $p_k$ ), as read from the pressure gauge (7). In theoretical analysis and experimental measurements, the pressure in the range  $p_k=0.2\div 0.8\text{ MPa}$  is considered to correspond to the minimum or maximum load torque at certain operating speeds of the system.

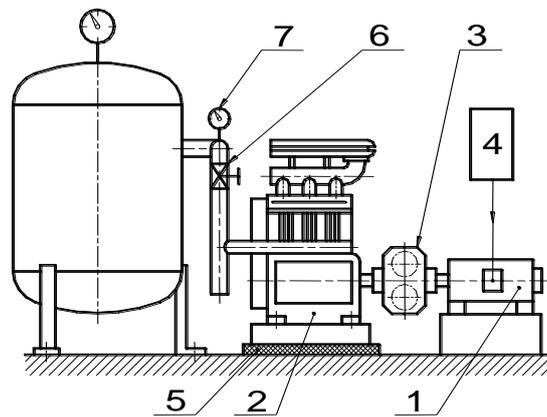

Fig. 3. Torsional oscillating mechanical system

##### 4.1. Analysis of the pneumatic tuner of torsional oscillation load

The analysis of the load of the pneumatic tuner of torsional oscillation when the mechanical system is in a steady state will be investigated on the basis of a schematic model of the torsional oscillating mechanical system (Fig. 4).

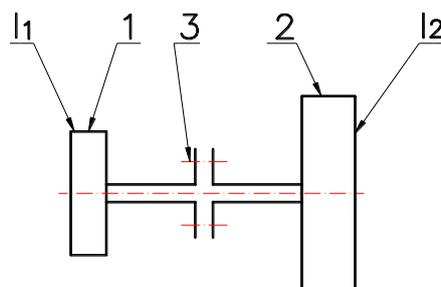

Fig. 4. Schematic model of a torsional oscillating mechanical system

When calculating the stress for the steady state of the mechanical system within its working mode, let us assume that the mechanical system rotates at angular velocity  $\omega$ , which varies over a wide range. A load torque acts on the mass ( $I$ ) with the moment of inertia  $I_1$  in the shape  $M_N + \sum M_i \cdot \sin(i \cdot \omega \cdot t + \gamma_i)$ . It follows from this relation that the pneumatic tuner, and hence the whole torsional oscillating mechanical system, are loaded both by the medium torque  $M_N$ , which does not change with the time in the steady state, and by the action of the harmonic component  $M_i$ . As a result, a component of additional dynamic torque  $M_d$  is introduced into the pneumatic tuner. Thus, the pneumatic tuner of torsional oscillation will be loaded in this case by the load torque  $M_S$ , which causes its maximum twist angle,  $\varphi_S$ .

$$M_S = M_N + M_d, \quad (2)$$

$$\varphi_S = \varphi_N + \varphi_d. \quad (3)$$

The magnitude of the additional dynamic torque and the dynamic element of the maximum twist angle calculated from the motion equations (4) can be characterized by relations (5) and (6).

$$I_2 \cdot \ddot{\varphi}_2 - b \cdot (\dot{\varphi}_1 - \dot{\varphi}_2) - k \cdot (\varphi_1 - \varphi_2) = 0. \quad (4)$$

$$M_d = \sum_{i=1}^n M_i \cdot \frac{I_2}{I_1 + I_2} \cdot \theta \cdot \sin[(i \cdot \omega \cdot t + \gamma_i) + \beta_i + \vartheta_i], \quad (5)$$

$$\varphi_d = \sum_{i=1}^n \frac{M_i}{I_1 \cdot \Omega_0^2} \cdot \xi \cdot \sin[(i \cdot \omega \cdot t + \gamma_i) + \beta_i + \vartheta_i], \quad (6)$$

## 5. THEORETICAL RESULTS OF OPTIMAL TUNING OF A TORSIONAL OSCILLATING MECHANICAL SYSTEM

Based on the theoretical results characterizing the size of torsional vibration, we evaluate the tuning of a torsional oscillating mechanical system. The size of torsional oscillation of the torsional oscillating mechanical system will be presented by:

- the amplitudes of torque oscillation in the pneumatic coupling depending on speed
- the dynamics twist angle amplitude of the coupling depending on speed

### 5.1. Results of the application of a tangential pneumatic tuner of torsional oscillation

The Campbell diagram, according to Fig. 6, characterizes the tuning of the mechanical system operating in the speed range  $n=750 \div 1,500 \text{ min}^{-1}$  by the tangential pneumatic tuner of torsional oscillation.

The diagram shows the critical speed positions  $n_k$  when dependent on the actual speeds  $N$ . The natural speeds are represented by the horizontal lines  $a, b, c, d, e, f, g$  for the entire gas pressure range of the pneumatic tuner  $p=100 \div 700 \text{ kPa}$ . Based on the figure, it can be stated

that the pneumatic tuner is capable of operating under all pressures of gaseous medium ( $p=100\div 700$  kPa). On the other hand, in terms of dynamic tuning, we are able to state that pneumatic tuning will be suitable for the given system under pressures  $p=200\div 600$  kPa. This is due to the resonance at the beginning of the operating mode at  $p=100$  kPa with the first harmonic component of the load torque at  $n=820$   $\text{min}^{-1}$ , while, at  $p=700$  kPa, the resonance also occurs with the first harmonic component, but at  $n=1,480$   $\text{min}^{-1}$ .

Based on the above, we will focus on the dynamic tuning characteristic of the realized system in the pressure range  $p=200\div 600$  kPa.

Based on the Campbell diagram (Fig. 5), it can be stated that the given tuner shifts the second to 12th harmonic component from the operating range. Critical speeds from the main harmonic component ( $i=3$ ) at pressures  $p=200, 300, 400$  and  $600$  kPa occurs at  $n_k=330, 360, 405, 440$  and  $460$  rpm. These values indicate that the torsional oscillating mechanical system is very well tuned due to the start of the operating mode. This fact is confirmed by the frequency ratio  $\eta=i.n/N$ , which, for the investigated pressures, acquires relatively high values of  $\eta=2.3\div 1.6$ . At the same time, we can see that the first harmonic component is reached in the range of gaseous pressure  $p=200\div 600$  kPa and in the operating speed range ( $n=750\div 1,500$   $\text{min}^{-1}$ ). It follows that, when using a pneumatic tuner, resonance with the harmonic component occurs at the given pressures. In particular, for pressures  $p=200, 300, 400, 500$  and  $600$  kPa, resonances occur at  $n_k=980, 1,090, 1,220, 1,330$  and  $1,430$  rpm.

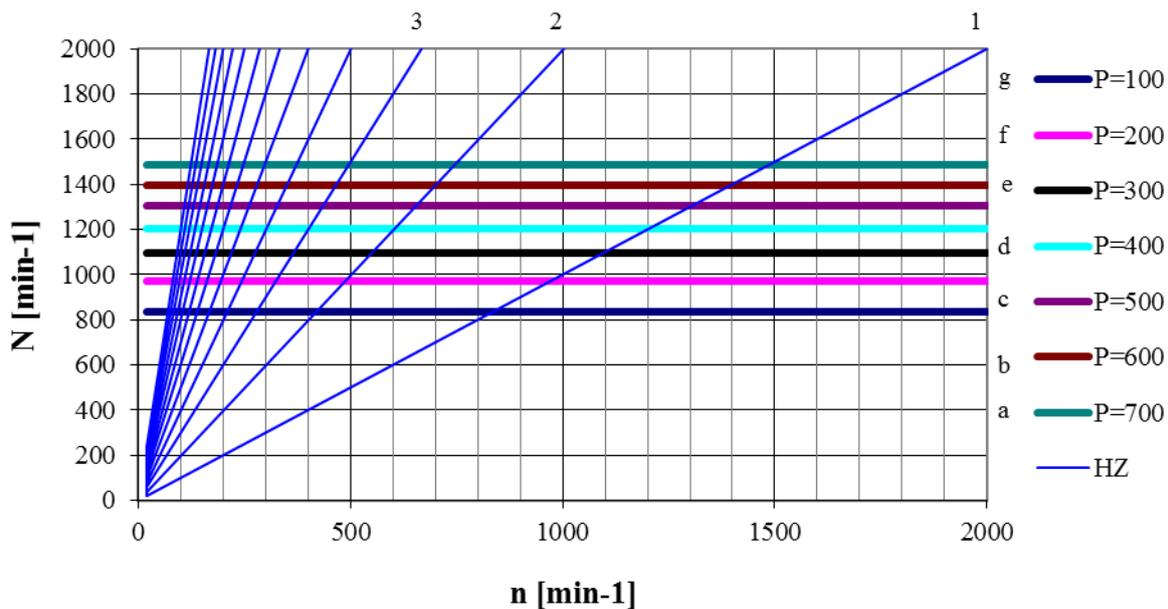

Fig. 5. Campbell diagram of a mechanical system with an applied pneumatic tuner of torsional oscillation (type 4-1/70-T-C) with constant pressures in the range  $p=100\div 700$  kPa

A suitable tuning of the torsional oscillating mechanical system by the tangential pneumatic tuner of torsional oscillation in relation to the main harmonic component ( $i=3$ ), as well as the operating speed range ( $n=750\div 1,500$   $\text{min}^{-1}$ ), is also confirmed by Figs. 6 and 7. Fig. 6 characterizes the dependency of the load torque dynamic component  $M_d$  on speed  $n$ , while Fig. 7 characterizes the course of the dynamic twist angle  $\varphi_d$ , depending on speed of the mechanical system with an applied tangential pneumatic tuner of torsional oscillation under constant pressures in the range  $p=100\div 700$  kPa.

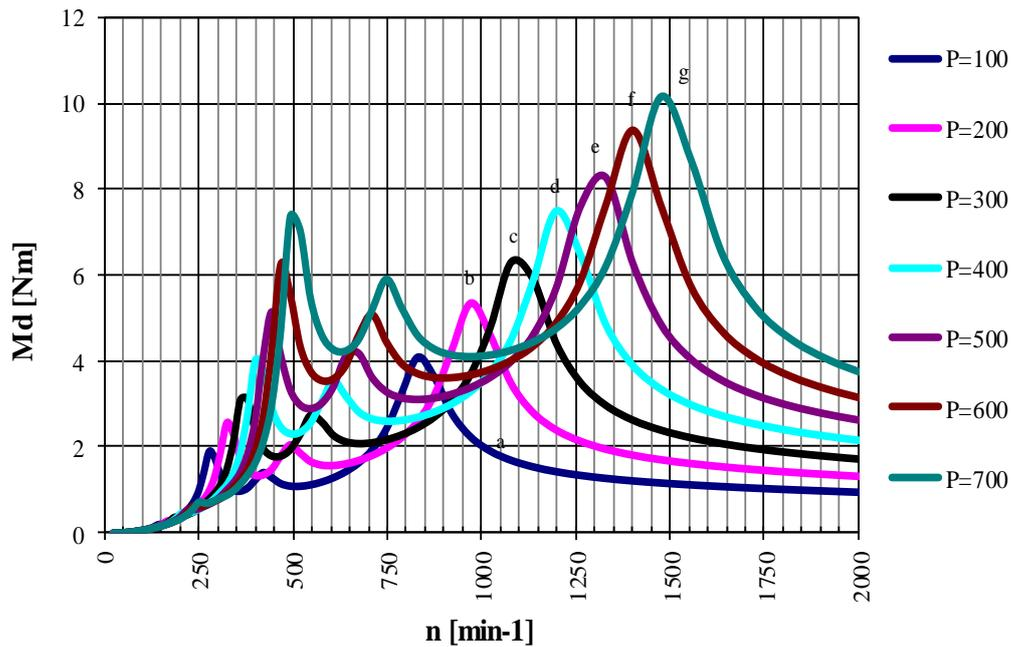

Fig. 6. Dynamic components of load torque  $M_d$  in speed range  $n=0\div 2,000$  min<sup>-1</sup> of a torsional oscillating mechanical system with the application of a tangential pneumatic tuner of torsional oscillation (type 4-1/70-T-C) under constant pressures in the range  $p=100\div 700$  kPa

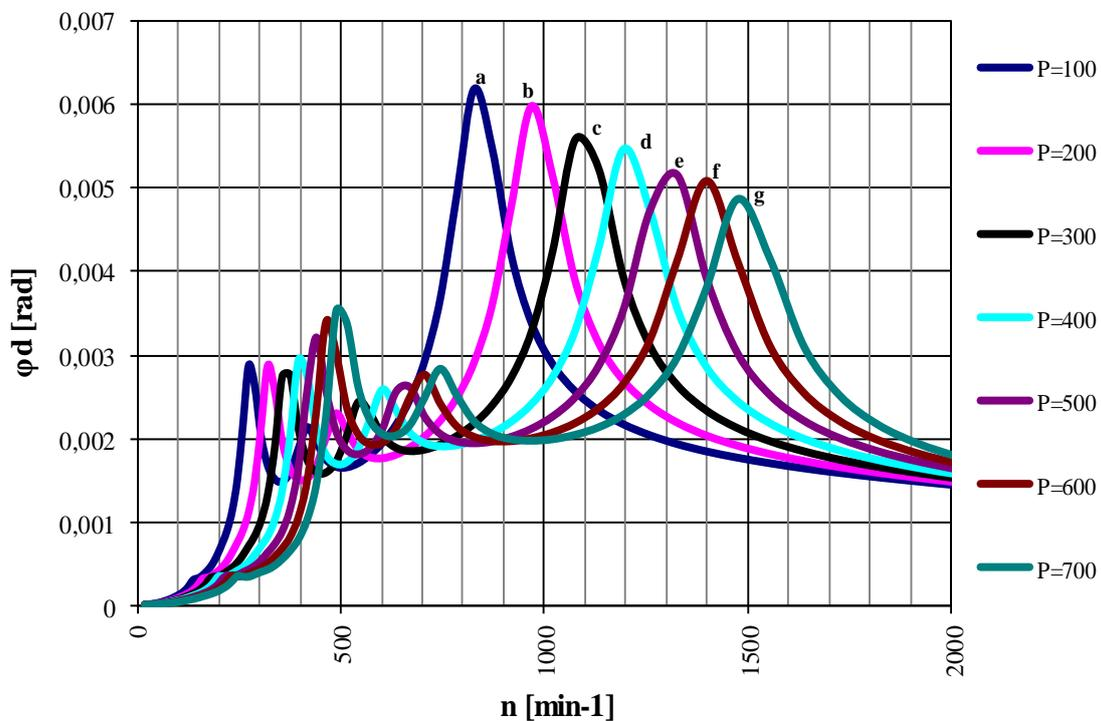

Fig. 7. Dynamic components of the twist angle  $\varphi_d$  in the speed range  $n=0\div 2,000$  min<sup>-1</sup> of a torsional oscillating mechanical system with the application of a tangential pneumatic tuner of torsional oscillation (type 4-1/70-T-C) under constant pressures in the range  $p=100\div 700$  kPa

## 6. CONCLUSION

Based on the presented results, it can be stated that the presented pneumatic tuners of torsional oscillation fulfil all requirements in terms of their application in torsional oscillating mechanical systems with both constant operating speeds and a range of operating speeds. At the same time, it was confirmed that reducing the adverse consequences of unforeseen disturbances that occur in mechanical systems is possible by applying the proposed optimization of torsional oscillating mechanical systems.

## References

1. Ankarali A., Z. Mecitoğlu, H. Diken. 2012. "Response spectrum of a coupled flexible shaft-flexible beam system for cycloidal input motion". *Mechanism and Machine Theory* 47: 89-102. ISSN: 0094114X.
2. Bingzhao G., C. Hong, Z. Haiyan, S. Kazushi. 2010. "A Reduced-order nonlinear clutch pressure observer for automatic transmission". *IEEE Transactions on Control Systems Technology* 18(2): 446-453.
3. Böhmer J. 1983. *Einsatz elastischer vulkan-kupplungen mit linearer und progressive drehfeder-charakteristik*. [In German: *Use of Elastic Volcano Clutches with Linear and Progressive Torsion Spring Characteristic*.] Berlin: MTZ Berlin 44/5.
4. ČSSR 259224 B6. *Pneumatická pružná hriadel'ová spojka s reguláciou tlmenia*. [In Slovak: *Pneumatic Flexible Shaft Coupling with Damping Control*.] Vysoká škola technická v Košiciach, ČSSR. 25 June 1987.
5. Czech P., J. Mikulski. 2014. "Application of Bayes Classifier and Entropy of Vibration Signals to Diagnose Damage of Head Gasket in Internal Combustion Engine of a Car". In: J. Mikulski (ed.). 14th International Conference on Transport Systems Telematics. Katowice Ustron, Poland. 22-25 October 2014. Telematics - Support for Transport. Book series: Communications in Computer and Information Science, Vol. 471: 225-232.
6. Czech P. 2013. "Intelligent approach to valve clearance diagnostic in cars". In: J. Mikulski (ed.). 13th International Conference on Transport Systems Telematics. Katowice Ustron, Poland. 23-26 October 2013. Activities of Transport Telematics. Book series: Communications in Computer and Information Science, Vol. 395: 384-391.
7. Figlus Tomasz, Marcin Stańczyk. 2016. "A method for detecting damage to rolling bearings in toothed gears of processing lines". *Metalurgija* 55(1): 75-78. ISSN: 0543-5846.
8. Figlus Tomasz, Marcin Stańczyk. 2014. "Diagnosis of the wear of gears in the gearbox using the wavelet packet transform". *Metalurgija* 53(4): 673-676. ISSN: 0543-5846.
9. Folega Piotr, Grzegorz Wojnar, Rafał Burdzik, Łukasz Konieczny. 2014. "Dynamic model of a harmonic drive in a toothed gear transmission system". *Journal of Vibroengineering* 16 (6): 3096-3104. ISSN 1392-8716.
10. Gąska Damian, Tomasz Haniszewski, Jerzy Margielewicz. 2017. "I-beam girders dimensioning with numerical modelling of local stresses in wheel-supporting flanges". *Mechanika* 23(3): 347-352. ISSN 1392-1207.



11. James D., Van de Ven, J. Cusack. 2014. "Synthesis and baseline testing of a digital pulse-width-modulated clutch". *Mechanism and Machine Theory* 78: 81-91. ISSN: 0094114X.
12. Krejčíř O. 1986. *Pneumatická vibroizolace*. [In Czech: *Pneumatic Vibration Isolation*.] Liberec: DDP.
13. Lacko P., V. Lacko 2000. "Continuously driven resonance". *Strojárstvo* 42 (3/4): 127-135.
14. Pešík L., P. Němeček. 1997. *Identification of the Dynamic System of a Machine with an Elastic Base*. Chicago, USA: McNU 97.
15. SR 5276 B1. *Pneumatická spojka bez prepojenia pružných dutých telies v tvare kotúča*. [In Slovak: *Pneumatic Coupling Without Linking Elastic Hollow Bodies in the Shape of a Disc*.] Technická univerzita v Košiciach, SR. 12 August 2009.
16. SR 5277 B1. *Pneumatická spojka so zabudovaným škrtiacim prepojením pružných dutých telies*. [In Slovak: *Pneumatic Coupling Without Linking Elastic Hollow Bodies in the Shape of a Disc*.] Technická univerzita v Košiciach, SR. 12 August 2009.
17. SR 278025. *Pneumatická pružná hriadeľová spojka so schopnosťou autoregulácie*. [In Slovak: *Pneumatic Flexible Shaft Coupling with Self-regulating Capability*.] Technická univerzita v Košiciach, SR. 1995.
18. SR 278272. *Pneumatická spojka s prídavným regulátorom konštantného uhla skrútenia*. [In Slovak: *Pneumatic Coupling with Additional Constant Curve Angle Regulator*.] Technická univerzita v Košiciach, SR. 1996.
19. SR 6219 B6. *Pneumatická pružná hriadeľová spojka s prídavným regulátorom konštantného uhla skrútenia*. [In Slovak: *Pneumatic flexible shaft coupling with additional constant-angle twist regulator*.] Technická univerzita v Košiciach, SR. 3 September 2012.
20. SR 5274 B1. *Mechanická sústava optimálne vyladená pneumatickou spojkou*. [In Slovak: *The Mechanical System Is Optimally Tuned by the Pneumatic Coupling*.] Technická univerzita v Košiciach, SR. 25 June 2009.
21. Wittek Adam Marek, Damian Gąska, Bogusław Łazarz, Tomasz Matyja. 2014. "Automotive stabilizer bar – stabilizer bar strength calculations using FEM, ovalization of radial areas of tubular stabilizer bars". *Mechanika* 20(6): 535-542. ISSN 1392-1207.
22. Yubao S., W. Jihong, Y. Dianlong, W. Xisen. 2013. "Analysis and enhancement of torsional vibration stopbands in a periodic shaft system". *Journal of Physics D: Applied Physics* 46 145306: 7-13. ISSN 0022-3727.
23. Zoul Václav 1984. *Torzni vibrace v pohonech a způsob jejich snižování*. [In Slovak: *Torsion Vibration in Drives and Their Reduction*.] Prague: ČSVTS.

VEGA 1/0473/17 "Research and development of technology for homogeneous charge self-ignition using compression in order to increase engine efficiency and to reduce vehicle emissions"

Received 04.08.2017; accepted in revised form 29.10.2017



Scientific Journal of Silesian University of Technology. Series Transport is licensed under a Creative Commons Attribution 4.0 International License