

# OPTIMIZATION AND COMPUTATIONAL FLUID ANALYSIS OF RAMP IN SCRAMJET INLET TO INCREASE COMPRESSION EFFICIENCY

SAHAYA PRINCE.D, FAZLUDEEN.J, SUDHARSAN.S & UTHAYA KUMAR.N

Dept. of Aeronautical Engineering, Infant Jesus College Of Engineering,  
Tuticorin, Tamilnadu, India.

**ABSTRACT:** In our project we have re-designed the rectangular type scramjet inlet in comparison of different ramp angles by making shock trains formed in isolator region for compression that happens inside the inlet has analysed through Computational Fluid Analysis with the airflow of high mach number passing over on it. Using CATIAV5 for designing the scramjet engine and by ANSYS-Workbench the followed designing of inlet through GEOMETRY (Design Modeler) and meshing by MESH (ICEM-CFD) & FLUENT analysis has been done for analyzing/checking the flow reactions. By re-designing an inlet which makes the compression that possibly efficient internally for such high mach number 10. The optimization of our project helps knowing all the aspects of and about ramp angle implementing to increase the compression efficiency.

**Key Words:** CATIAV5, ANSYS, Ramp Angle, K- $\epsilon$  Turbulence Model

## Introduction:

A supersonic combustion ramjet (scramjet) is a variant of a ramjet air-breathing combustion jet engine. The definition of ramjet engine is first necessary, as a scramjet engine is a direct descendant of a ramjet engine. Ramjet engines have no moving parts, instead operating on compression to slow free stream supersonic air to subsonic speeds, thereby increasing temperature and pressure and then combusting the compressed air with fuel. Finally, a nozzle accelerates the exhaust to supersonic speeds, resulting in thrust.

Due to the deceleration of the free stream air, the pressure, temperature and density of the flow entering the burner are “considerably higher than in the free stream”. At flight Mach numbers of around Mach 6, these increases make it inefficient to continue to slow the flow to subsonic speeds. Thus, if the flow is no longer slowed to subsonic speeds, but rather only slowed to acceptable supersonic speeds, the ramjet is then termed as supersonic combustion ramjet, resulting in the acronym scramjet. To study the inlet performance, multiple standard parameters need to be evaluated.

This study involves comparison of performance parameters for scramjet inlet which are evaluated as a result of FEM computation of 2-D turbulent flow field around six different scramjet inlet geometries. The salient geometrical parameters which are varied are; inlet ramp angle and length, cowl lip angle, leading edge and axisymmetric inlet. The 2-D computation of turbulent flow is obtained by implementing high Reynolds number k- $\omega$  compressible turbulent formulation.

The boundary and initial conditions are carefully selected to the free stream conditions that pertain to a cruise altitude of 25km. The simulations were performed for two free stream Mach number 8. Thus from the obtained result, comparative studies of performance parameters are carried out by parameterising geometrical variables and free stream Mach number.

It is necessary to simulate the inlet design to obtain the appropriate inlet performance. Computational Fluid Dynamics (CFD) is used to study flight simulations in both steady and un-steady flow. A time-averaged, viscous, two Dimensional, CFD scheme used to compute aero-thermodynamic quantities including boundary layer effects. A variety of turbulent models available ranging from one to three equations transport models. Oblique shock waves, expansion waves and shock wave interactions are mainly considered.

Accuracy of the solution is dependent on many parameters like size of the control volume, orientation of boundaries, discretization and its order of accuracy.

### **Scramjet Inlet:**

Intake is the most vital component of the engine. It converts the K.E of the air flow into a static pressure rise that helps in deceleration of flow at lower speeds. This deceleration takes place as the flow passes through a series of oblique shocks that are formed due to the presence of ramps in the inlet, also called as staged compression. The internal inlet compression provides the final compression of the propulsion cycle.

The forebody along with the internal inlet is designed to provide the required mass capture and aerodynamic contraction ratio at maximum inlet efficiency. The air in the captured stream tube undergoes a reduction in Mach number with an attendant increase in pressure and temperature as it passes through the system of shock waves in the fore body and internal inlet. It typically contains non-uniformities, due to oblique reflecting shock waves, which can influence the combustion process.

A scramjet air induction phenomenon includes vehicle bow shock and isentropic turning Mach waves, shock boundary layer interaction, non-uniform flow conditions, and three-dimensional effects.

### **Ramp Angle:**

An intake ramp is a rectangular plate-like device within the air intake of a jet engine designed to generate a number of shock waves to aid the inlet compression process at supersonic speeds. The ramp sits at an acute angle to deflect the intake air from the longitudinal direction.

At supersonic flight speeds, the deflection of air stream creates a number of oblique shock at each change of gradient along the ramp. Air crossing each shock wave suddenly slows to a lower mach number, thus increasing pressure.



Inlet Ramp

Ideally, the first oblique shock wave should intercept the air intake lip, thus avoiding air spillage and pre-entry drag on the outer boundary of the deflected streamtube. For a fixed geometry intake at zero incidence, this condition can only be achieved at one particular flight mach number, because the angle of the shock wave to the longitudinal direction becomes more acute with increasing aircraft speed.

More advanced supersonic intakes feature a ramp with a number of discrete changes of gradient in order to generate multiple oblique shock waves. For a fixed geometry it is feasible to use curved intakes without any shock before the final normal shock.

Variable geometry intakes, such as those on concorde, vary the ramp angle to focus the series of oblique shock waves onto the intake lip, control of which is accomplished by complex non-linear control laws using the ramp void pressure as a control input.

#### **K-epsilon (k- $\epsilon$ ) turbulence model:**

It is the most common model used in Computational Fluid Dynamics (CFD) to simulate mean flow characteristics for turbulent flow conditions. It is a two equation model which gives a general description of turbulence by means of two transport equations (PDEs). The original impetus for the k-epsilon model was to improve the mixing length model, as well as to find an alternative to algebraically prescribing turbulent length scales in moderate to high complexity flows.

The first transported variable determines the energy in the turbulence and is called **turbulent kinetic energy (k)**.

The second transported variable is the **turbulent dissipation ( $\epsilon$ )** which determines the rate of dissipation of the turbulent kinetic energy.

*k- $\epsilon$  turbulence model derives two equations in CFD analysis and they were., Continuity and Momentum equation (u & v momentum eqn).*

## **ANSYS-WORKBENCH:**

ANSYS Workbench platform is the framework upon which the industry's broadest deepest suite of advanced engineering simulation technology is built. An innovative project schematic view ties together the entire simulation process, guiding the user through even complex multi-physics analyses with drag-and-drop simplicity.

With bi-directional CAD connectivity, powerful highly-automated meshing, a project-level update mechanism, pervasive parameter management and integrated optimization tools, the ANSYS Workbench platform delivers unprecedented productivity, enabling Simulation Driven Product Development.

The version of ANSYS software we used in our project designing and analyzing is *ANSYS-Workbench 17.1*

### **Inlet Ramp Angle Selection:**

A design of Ramp types selected in our project are draw through Graphical User Interface (GUI) in ANSYS-Workbench Design Model.

### **Methodology:**

The design geometry we drawn in ANSYS Design Modeler are as follow.,

- ✓ Sharp Axi-symmetric Ramp Inlet.
- ✓ Sharp Four Ramp Angle Inlet.
- ✓ Sharp Five Ramp Angle Inlet.

The sketching of ramp design in ANSYS-Workbench has tools that to create the sketch that then by using constraints and dimensions the desirable geometry has drawn.

After completing the sketch, the boundary used for fixing the sketch that a body that influencing the sketch of ramp model. Through Surfaces from sketches, the sketch then formed as a surface for further consideration.

**Selected Ramp Angle Parameters:**

Leading edge	Sharp
No. of ramps	Three
Ramp angles	5.5°, 10.8°, 14.1°
Throat area	50mm

Table 1., Sharp axi-symmetric Inlet Specifications

Leading edge	Sharp
No. of ramps	Five
Ramp angles	5.5°, 6.05°, 8.14°, 9.60°, 11.5°
Cowl angle	11.5°
Throat area	60mm

Table 2., Five Ramp Angle Inlet Specifications

Leading edge	Sharp
No. of ramps	Four
Ramp angles	5.5°, 7.55°, 9.05°, 12.5°
Cowl angle	12.5°
Throat area	60mm

Table 3., Four Ramp Angle Inlet Specifications

**Geometry and Grid Generation:**

**Computational Model:**

This problem analyses the flow analysis of air along the inlet ramp angle. The mole fractions of each of the species are also shown in the analysis.

Procedure in the way of analysis were.,

1. Draw a Geometry of 2-Dimensional sketch in the Design Modeler.
2. Using Mesh the following mesh has to be carried out for further analyzing process.
3. Analysis in Fluent, the selection of inputs and Boundary Conditions are to be considered.
4. Select the k- $\epsilon$  Turbulence Model for analysis which solves two equations
5. Check On the Energy Equation.
6. Preferred Boundary Conditions are to be applied.
7. Results were taken.

### Create Modeling:

#### Sharp Axi-Symmetric Inlet Geometry:

The sharp axi-symmetric model used to drawn in ANSYS-Workbench as.,

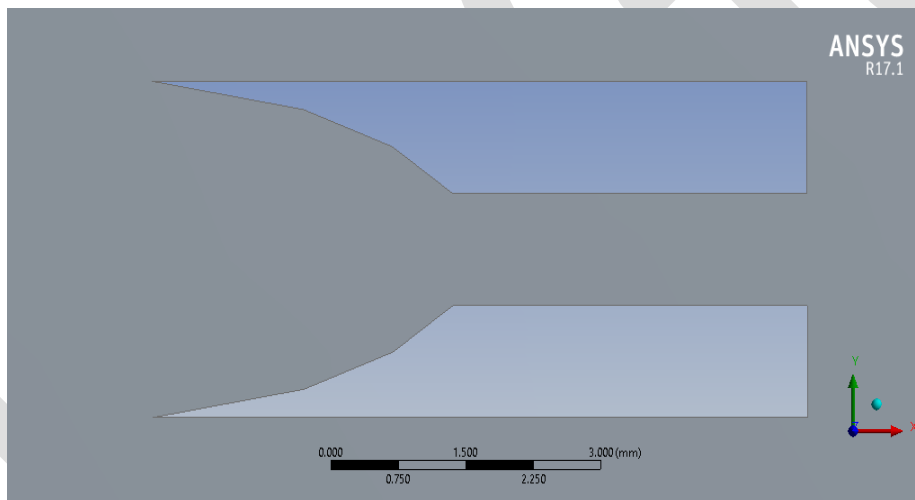

Geometry of Axi-symmetric Inlet

#### Five and Four Ramp Angle Inlet Geometry:

Five and Four ramp angle inlet model has drawn in ANSYS-Workbench as.,

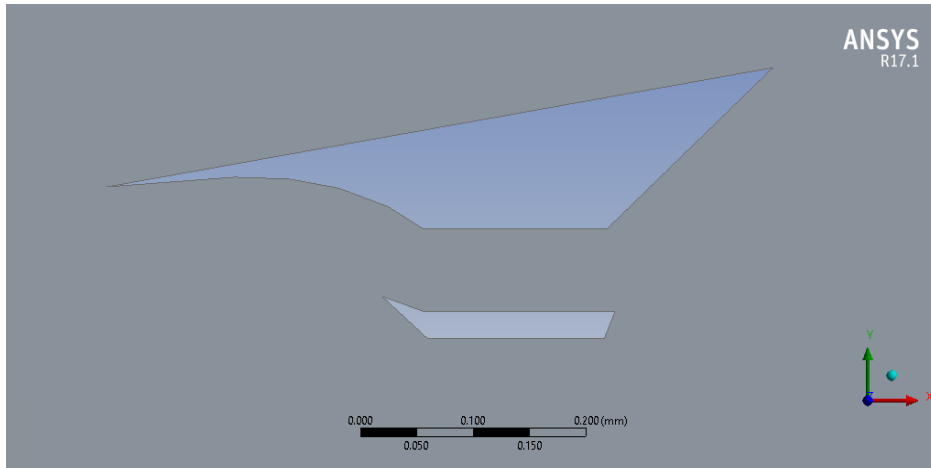

Five Ramp Angle Inlet Geometry

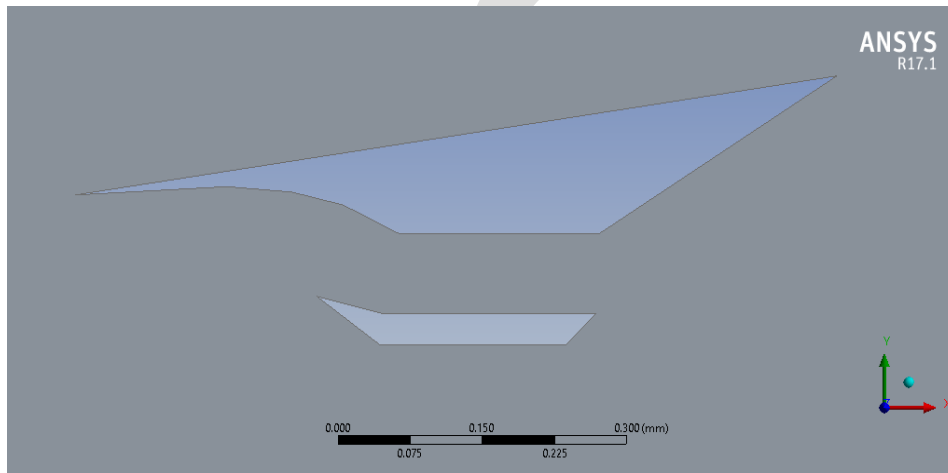

Four Ramp Angle Inlet Geometry

#### MESHING:

A mesh is the **Discretization** of the component into a number of small elements of defined size. Finite element analysis is dividing the geometry into various small numbers of elements. These elements are connected to each other at points called nodes. Each node may have two or more than that elements connected to it. A collection of these elements is called mesh.

Meshing is a very important part of pre-processing in any **FEA** software. In **ANSYS-Workbench** there are many tools and options available to help you create an effective mesh. And effective mesh is one that requires less computational time and gives maximum accuracy.

In ANSYS-Workbench, you can generate mesh with the default settings available when you start the software. You can also set parameters as per your requirements to generate the mesh.

### Create Meshing:

### Meshing Of Inlets:

Meshing of all the inlet type for the considered geometry will then draw through ANSYS-Mesh (ICEM-CFD) as follow.,

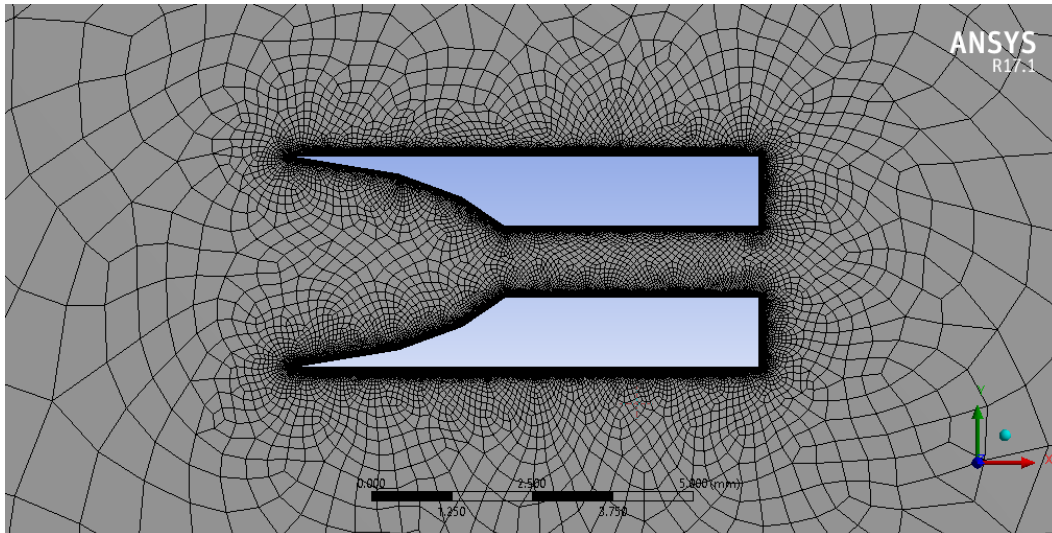

Mesh Of Axi-Symmetric Inlet Design

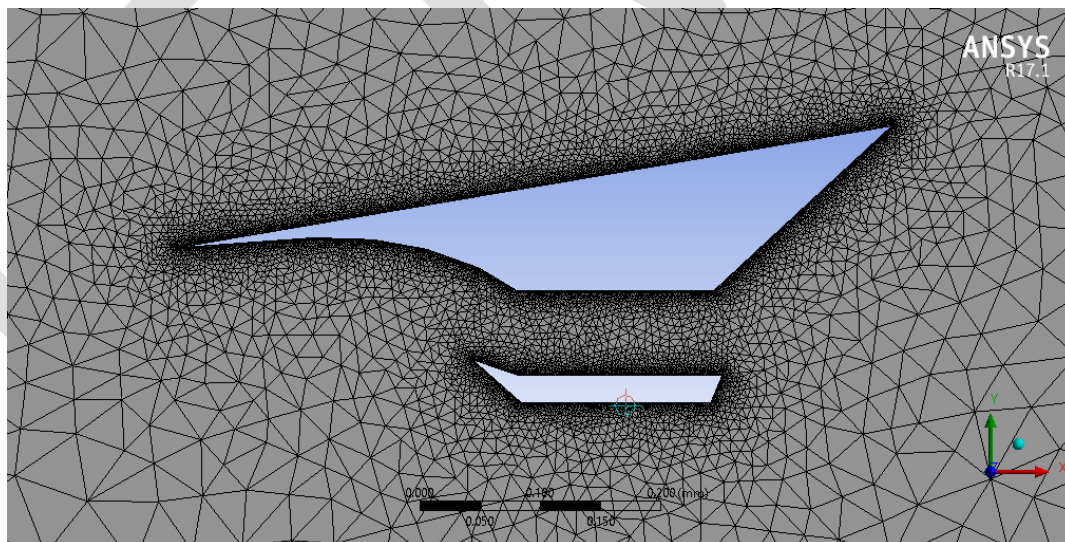

Mesh Of Five Ramp Angle Inlet Design



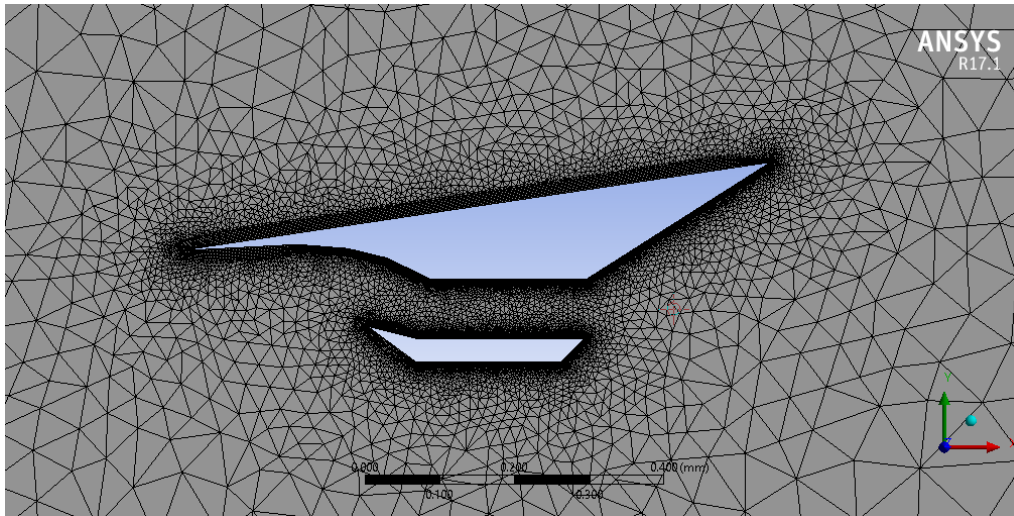

Mesh Of Four Ramp Angle Inlet Design

In global meshing, the mesh selected is for CFD analysis with fine mesh and the quality of hard smoothing.

In local meshing, the body sizing, edge sizing and inflation has done to qualify the meshed model for better accurate results. By doing smaller divisions of elements assumed as minimum sizing of 0.02mm and number of elements as between 8 to 12.

### Result and Analysis:

Two dimensional simulations of the flow field using FLUENT are to be made. Computations validated through the simulation of hypersonic inlet at desired mach number.

### Boundary Conditions:

Inlet	Velocity inlet
Outlet	Pressure outlet
Upper boundary	Wall
Lower boundary	Wall
Body & Cowl	Farfield
Fluid	Air
Mach number	10
Gauge pressure	1197 pa
Reference temperature	226.5 k

Turbulent viscosity	0.01
Turbulent ratio	10

Table 4., Boundary conditions

### Fabrication of Scramjet Engine



Fully Fabricated Scramjet Engine

### ANALYSIS OF SCRAMJET INLET IN FLUENT

#### Case 1 – Sharp Axi-symmetric Inlet

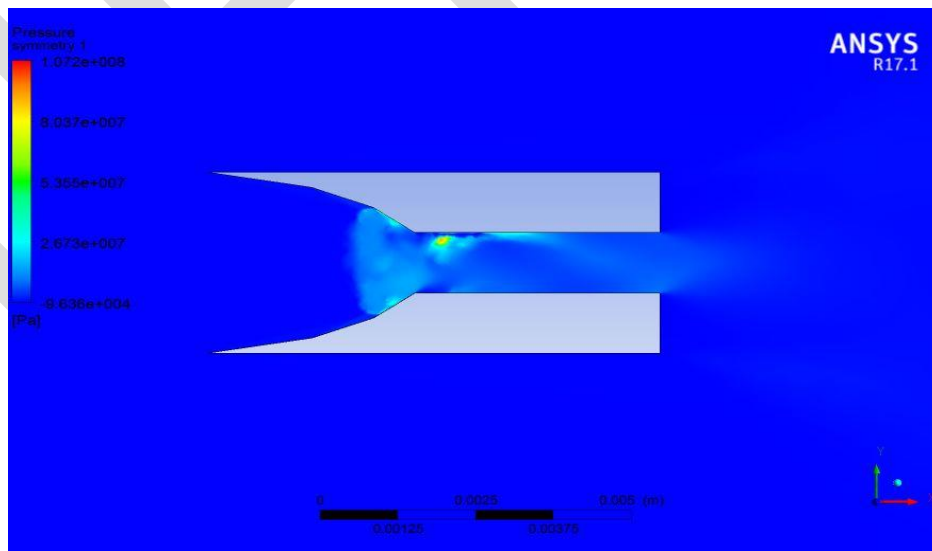

Axi-symmetric Pressure Contour

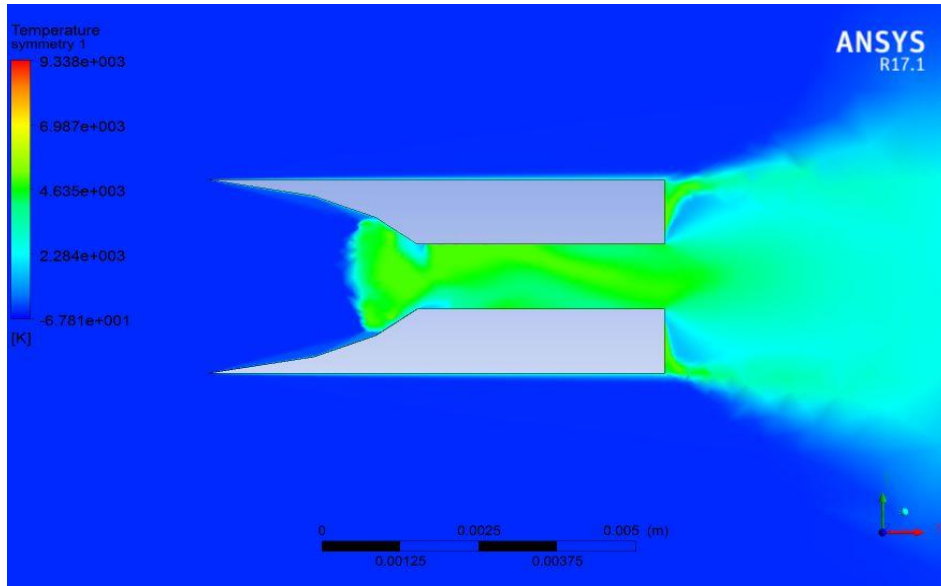

Axi-symmetric Temperature Contour

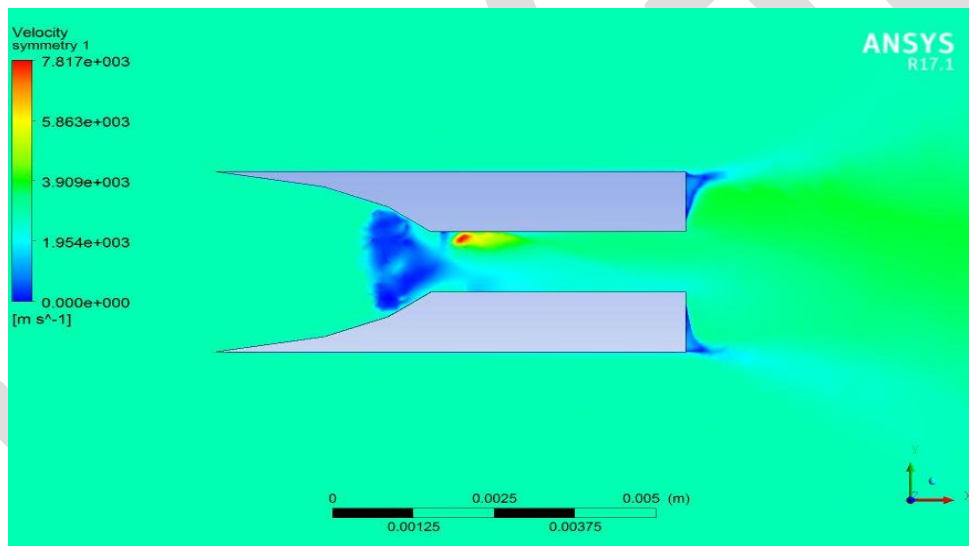

Axi-symmetric Velocity Contour

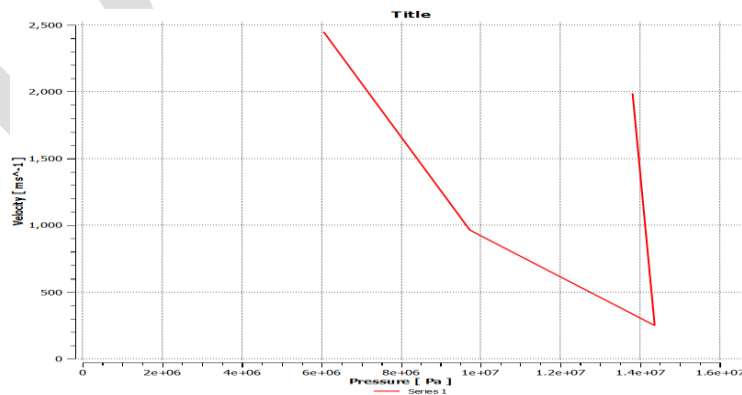

Pressure to Velocity at Inlet

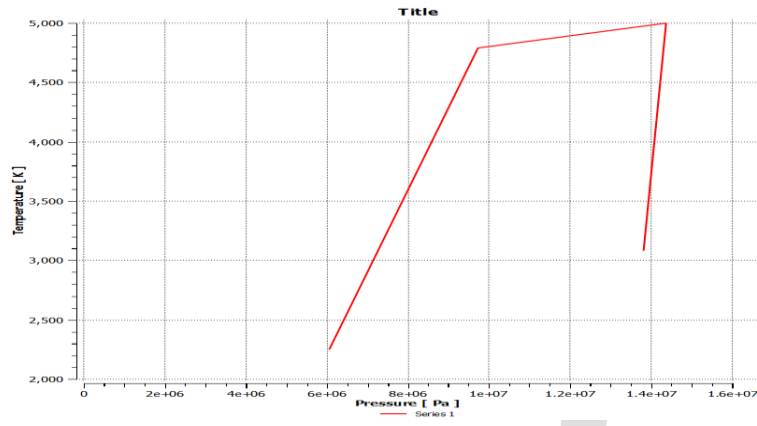

Pressure to Temperature at Inlet

### Case 2 – Five Ramp Angle Inlet

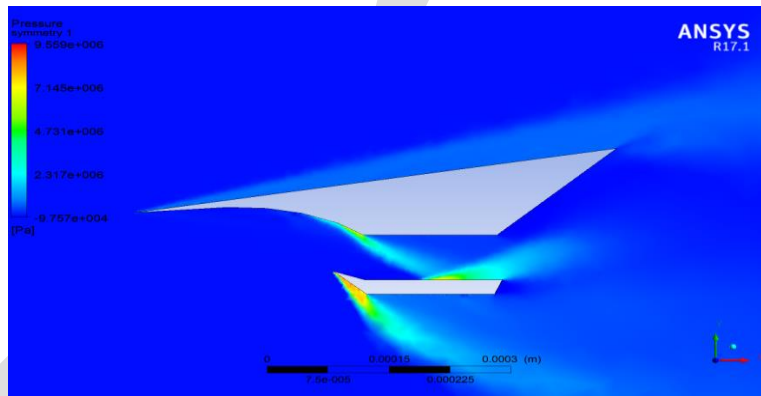

Five Ramp Pressure Contour

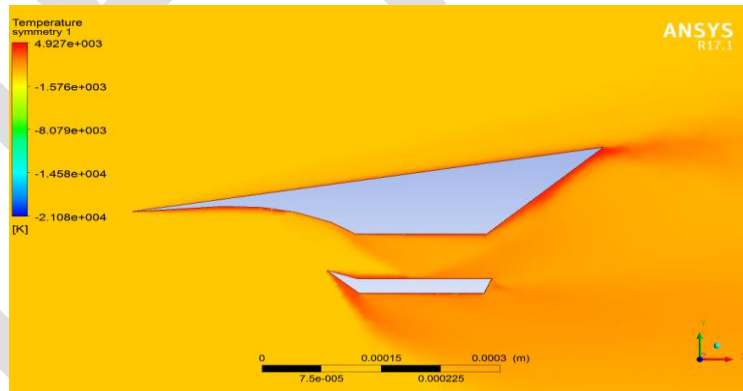

Five Ramp Temperature Contour

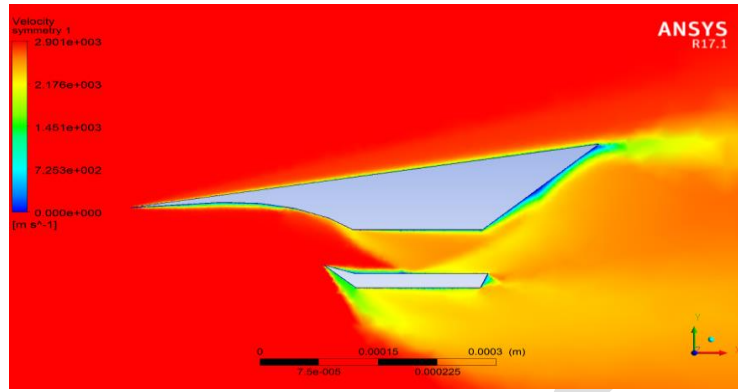

Five Ramp Velocity Contour

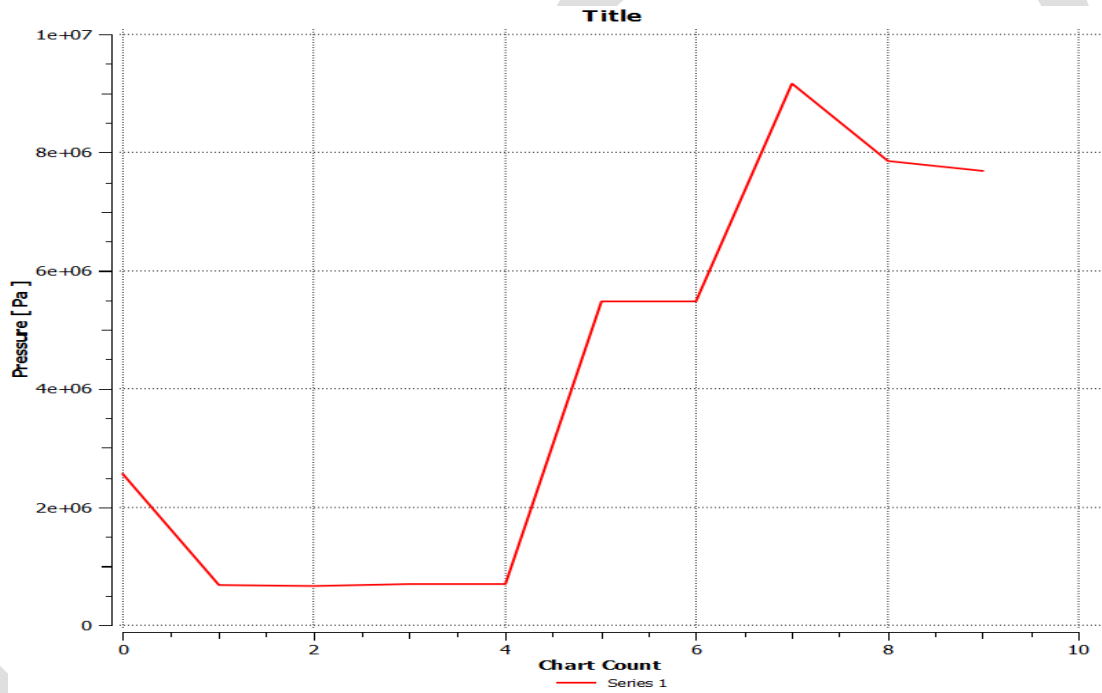

Pressure at inlet

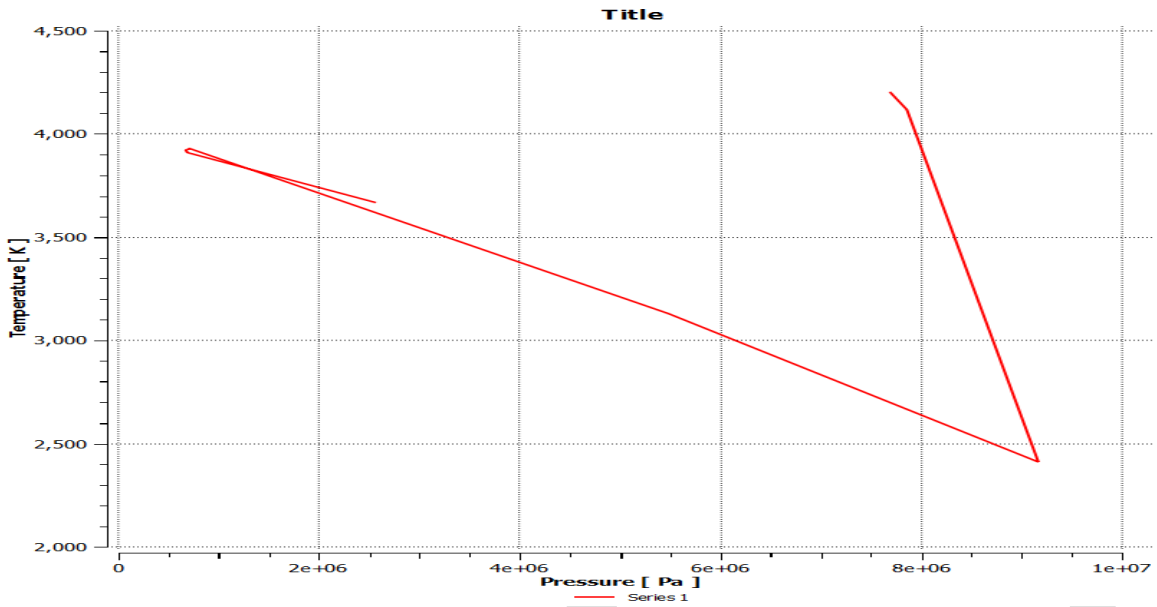

Pressure to Temperature at Inlet

### Case 3 – Four Ramp Angle Inlet

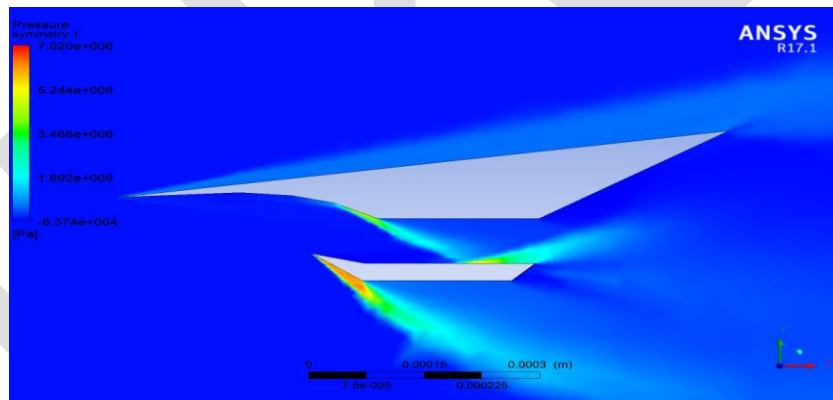

Four Ramp Pressure Contour

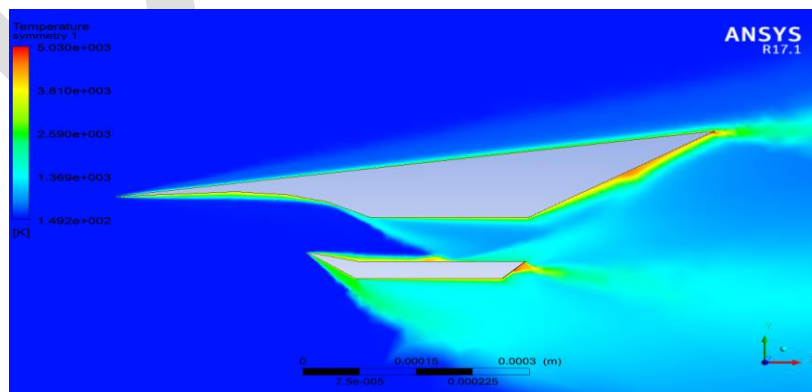

### Four Ramp Temperature Contour

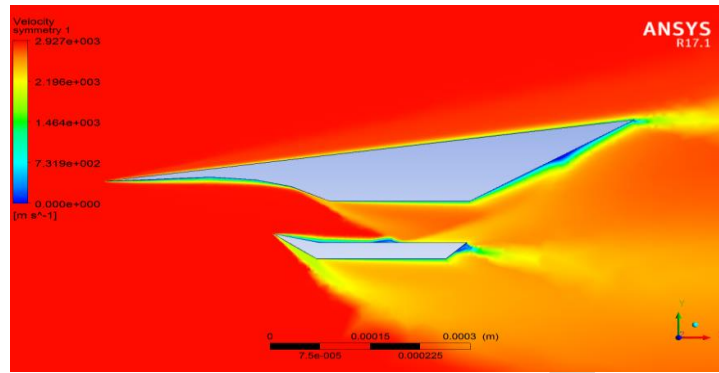

### Four Ramp Velocity Contour

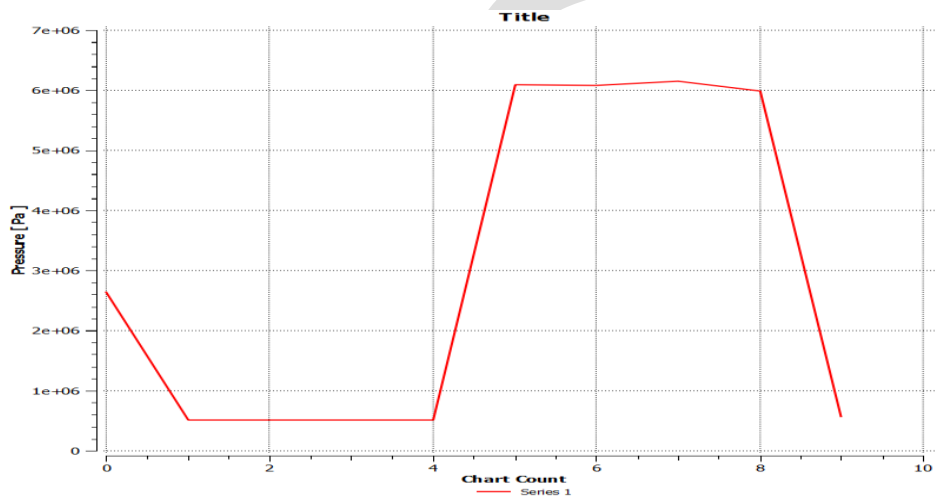

### Pressure at Inlet

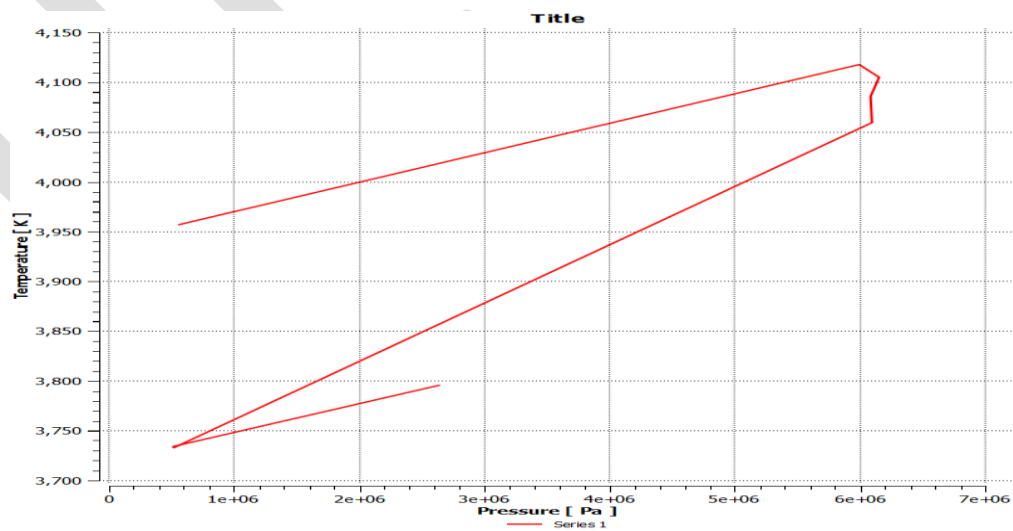

### Pressure to Temperature at inlet

Parameters	Sharp Axi-symmetric Inlet		Five Ramp Angle Inlet		Four Ramp Angle Inlet	
	Min	Max	Min	Max	Min	Max
Static Pressure	-96355.5 pa	1.07e6 pa	-97569.1 pa	9.55e6 pa	-83744.6 pa	7.02e6 pa
Static Temperature	-67.81 k	9338.13 k	-21083.9 k	4926.75 k	149.2 k	5029.8 k
Velocity Magnitude	0 m/s	7817.36 m/s	0 m/s	2901.36 m/s	0 m/s	2927.4 m/s
Density	0.0035 kg/m <sup>3</sup>	74.76 kg/m <sup>3</sup>	0.0036 kg/m <sup>3</sup>	9.65 kg/m <sup>3</sup>	0.015 kg/m <sup>3</sup>	10.54 kg/m <sup>3</sup>
U Velocity	-1.202e3 m/s	5.21e3 m/s	-36.101 m/s	2901.26 m/s	-585.17 m/s	2925.95 m/s
V Velocity	-3.08e3 m/s	6.02e3 m/s	-1605.75 m/s	1893.95 m/s	-1427.4 m/s	1738.13 m/s

Table 5., CFD Result Comparison

**Conclusion**

In this project, the Computational Fluid Dynamics Analysis is performed by using ANSYS-Workbench and ANSYS-Fluent software`s. Analysis has compared to all these three cases of inlet types as.,

Case 1: Sharp Axi-symmetric Inlet.

Case 2: Sharp Five Ramp angle inlet.



Case 3: Sharp Four ramp angle inlet.

When the upcoming air that enters into the rectangular type inlet, through the ramp angle design the air that facing the inlet has distracted and the process of shock formation that possibly attain inside the inlet lip which then makes the flow of air be compressible that then helps the flow as pressurized to meet the combustion chamber of mach 1. The name supersonic combustion happens inside the chamber that possible if the pressurized air be so effectively compressed by shock waves that makes through ramp angle deflection. In this present work project, the simulation of ramp angle types that in the scramjet inlet rectangular type is analyzed. Optimization in ramp angle re-design has considered as effective and implementing that in inlet design were possibly analyzed as efficient in compression and make it more effective in pressure formation. Five ramp angle inlet simulation results as the most preferable one as it gives efficient in compression at the selected mach number and has better performances.

**REFERENCES:**

1. Luu Hong Qyan, Nguyen Phu Hung, Le Doan Quang, Vu Ngoc Long, "Analysis and Design of a Scramjet engine Inlet operating from mach 5 to 10" "Science Publishing Group" 2016.
2. Ajay kumar, S.N. Tiwari, "Analysis of Scramjet Inlet flow field using 2D Navier-Stokes equations" "NASA Contractor Report 3562", Langley Research Centre 1982.
3. Michael k. Smart, "Scramjet Inlets" Centre of Hypersonics, NATO OTAN & ORT Organization, Approved OMB No. 0704-D188, 2010.
4. B. Reinartz, "Performance Analysis of a 3D Scramjet Intake" AICES Technical Report, 2008-13.
5. V. Rajashree, P. Manivannan, G. Dinesh Kumar, "Computational Analysis of Scramjet Inlet" International Journal of Innovative Research in Science, Engineering and Technology, Volume 3, Issue 3, 2014.
6. Ramesh Kolluru and Vijay Gopal, "Comparative Numerical Studies of Scramjet Inlet Performance using k- $\epsilon$  Turbulence Model with Adaptive Grids" COMSOL Conference, 2012.
7. Yufeng Yao & Danial Rincon, Yao Zheng, "Shock Induced Separating Flows in Scramjet Intakes" International Journal of Modern Physics Conference Volume 19, 2012.
8. Bo Huang, Zhufei Li, Jiming Yang, Xisheng Luo, "An Experimental Observation of 3D Scramjet Inlet Flow in Shock Tunnel" 10<sup>th</sup> International Conference on Fluid Control, Measurements and Visualization, 2009.

9. Kristen Nicole Roberts, "Analysis and Design of a Hypersonic Scramjet Engine with a Starting Mach Number of 4" Project in University of Texas, 2008.
10. Richard J. Weber & John S. Mackay, "An Analysis of Ramjet Engine using Supersonic Combustion" Technical Note-4386, National Advisory Committee for Aeronautics, 1958.

IJERGS