

# Analysis of HVDC Link in Large Scale Offshore Wind farm, Study and Comparison of LCC and VSC Based HVDC Links and Interconnection of Asynchronous Power Systems Utilizing VSC-Based HVDC Converter

\*Usman Raees Baig, \*\*Mokhi Maan Chang

\*Student of Department Of Electrical Engineering, Mehran University of Engineering and Technology, Jamshoro. [usmanraeesbaig@gmail.com](mailto:usmanraeesbaig@gmail.com)

\*\* Assistant Professor of Department Of Electrical Engineering, Mehran University of Engineering and Technology, Jamshoro

**Abstract**— HVDC transmission system and offshore wind farms are not very popular in many countries across the globe. This paper highlights research on offshore wind farms as it contains many advantages over onshore wind parks. Also on possibilities of appropriate transmission schemes, if Pakistan is to have offshore wind farms in premises of Arabian Sea in future years. Grid integration, design layout and power quality issues in offshore wind farms and comparison of two HVDC technologies by simulated models of HVDC system are discussed. At the end results are concluded from simulated models of HVDC link and appropriate scheme for offshore wind farm design is selected showing that two Dc interconnected systems are more feasible for operation than Ac interconnected system.

**Keywords**— HVDC transmission, Offshore Wind farms, Low voltage ride through (LVRT), Voltage source converter (VSC), Line Commutated Converter (LCC).

## 1. INTRODUCTION

Due to high wind pressure and abundant space in oceans. The offshore wind farms which consist of large and modern wind turbines are replacing many small onshore wind farms. In present era large offshore wind farms like Horns Rev (160MW) or Nysted (165MW) in Denmark are in operating condition also number of offshore wind farms are under planning all across the Globe due to large and shallow offshore reservoirs [1]. Extensive construction of such wind farms means that our power system is more vulnerable on the wind speed. Therefore adequate arrangements are to be made for stability, protection scheme and power quality issues in order to make our system stable and free from transients or to scour from any sort of intricate situation in our power system.

Denmark has credit to initialize the practical concept of offshore wind parks. As there is strong wind speed in ocean as compared to land. Offshore wind parks have been installed in several parts of the world, due to the cleanliness and green production of electrical energy. Pakistan recent wind power projects are all onshore. However, Pakistan does have the capability to install offshore wind farm in premises of Arabian Sea as shown in the wind map report proposed by NASA/SSE (**Fig. 1**) the wind speed in offshore areas of Pakistan is around 6 to 6.5 (m/s) annually [2] which is best suited for the offshore wind power generation.

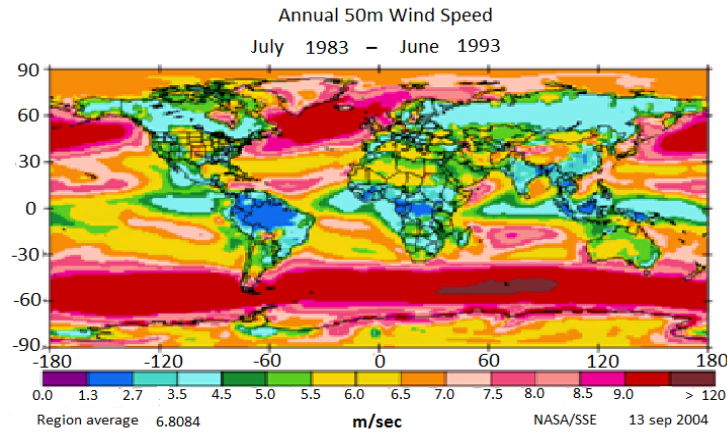

**Fig 1.** Wind Map from NASA/SSE Report

## 2. HVDC TRANSMISSION SYSTEM

Mostly offshore wind power plants are located hundreds of kilometers away from load centers AC transmission system can't be implemented because of high line losses. Therefore HVDC transmission system is best suitable method to transmit high amount of power with least possible losses. In case of HVDC transmission at the generating station the voltage is stepped up. Before the power is transmitted through HVDC transmission system this generated power is rectified by using Ac to Dc converters (rectifier). Then near the load centers or at termination points power is inverted by using Dc to Ac converter (inverter) then this inverted power is distributed to the load centers [3].

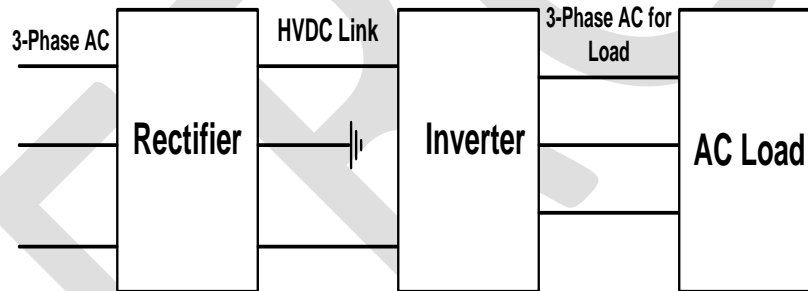
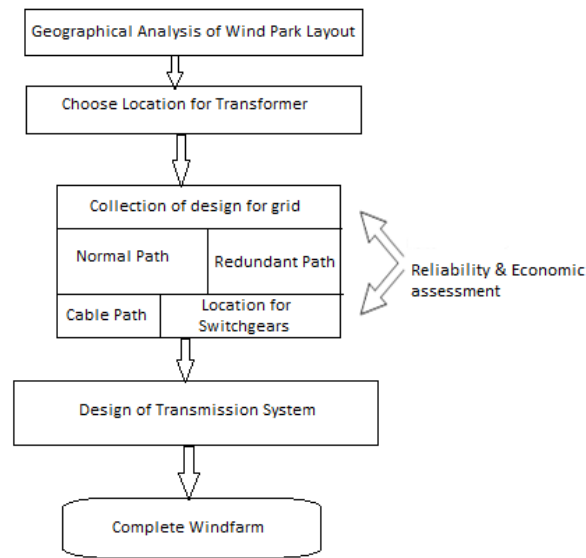

**Fig :** HVDC Transmission System

## 3. DESIGN PROCESS DESCRIPTION

The procedure for optimization is illustrated below.

1. On the basis of fixed wind park layout, choose appropriate place for transformer.
2. Considering cost limitations, plan string structure on the basis of former work.
3. After reliability analysis and economic cost assessment, construct suitable redundancy design.

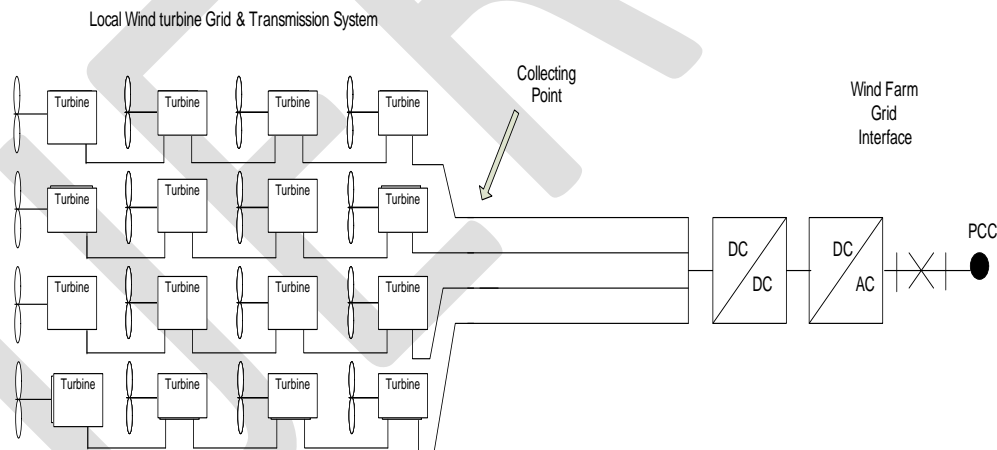

**Fig3.** Hierarchy Chart for Design of Wind Farm

#### 4. DESIGN LAYOUTS

##### 4.1 Small DC wind farm

In this every wind turbine is connected to rectifier and thus DC power sent to grid interface is inverted and then fed to grids. System topology is shown in (Fig. 4).



**Fig 4.** Small DC Wind Farm Layout

##### 4.2 Large parallel DC wind farm

Each section consists of number of wind farms which are connected to DC/DC converter. After that DC power is supplied to main grid interface where this DC power is boosted and fed to wind farm grid interface where it is inverted and transmitted to grids [4]. System topology is shown in (Fig. 5).

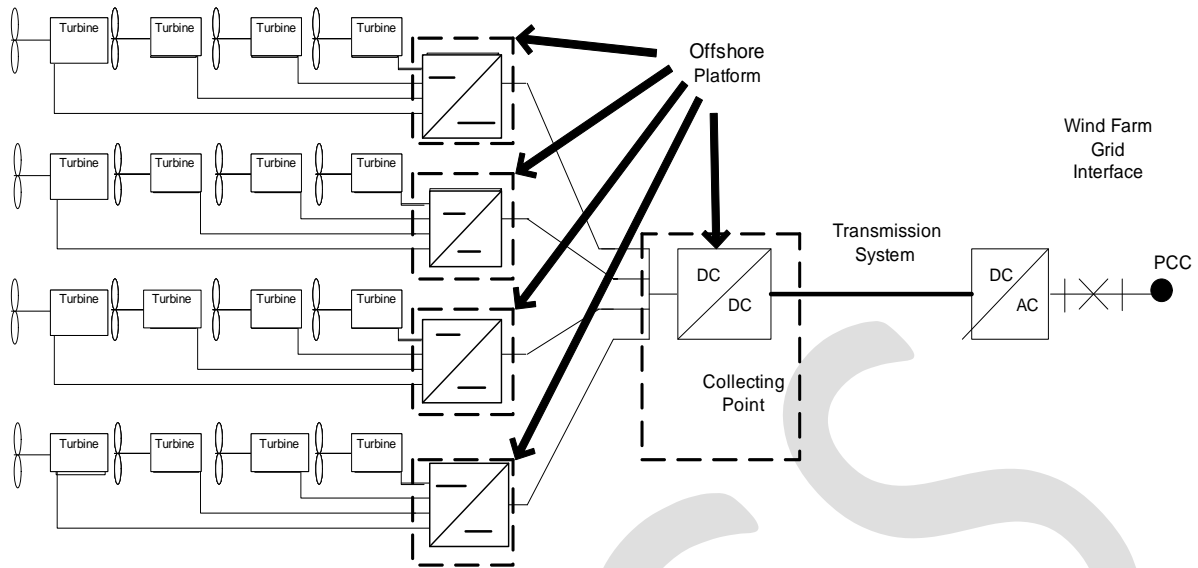

**Fig 5: Large DC Wind Farm Layout**

### 4.3 Series DC wind farm

Here 'n' number of wind turbines are in series arrangement to get the voltage level feasible for transference as well as 'm' number of series connection are made in parallel in order to get desired power level [4]. Main advantage of this topology is, here DC generators are used and bulk DC power is directly inverted without any need of rectifiers.

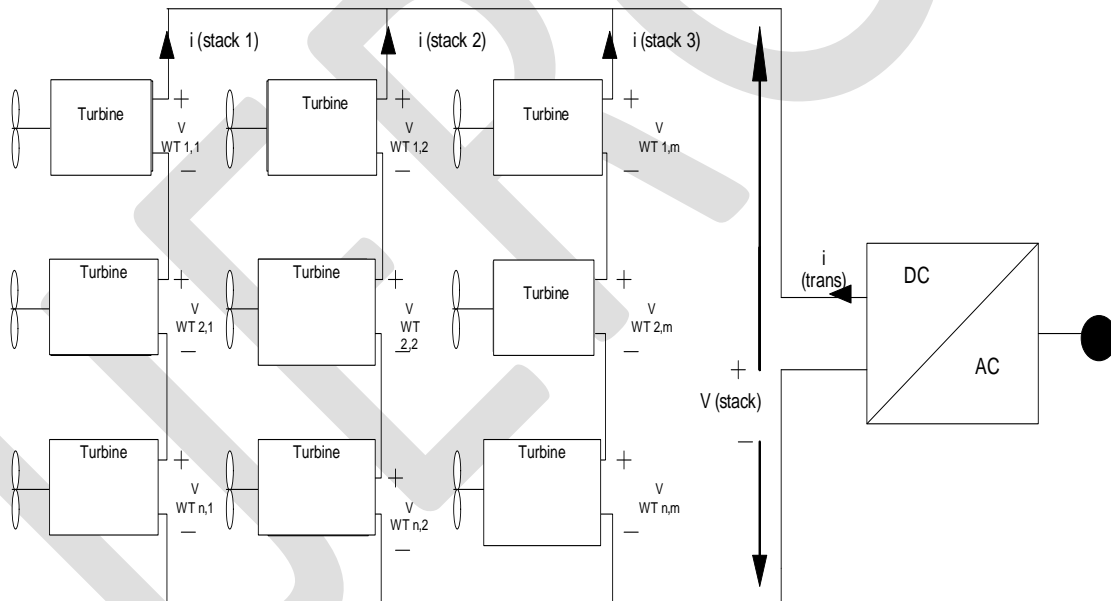

**Fig 6: Series Wind Farm Layout Based on DC Generators**

## 5. OFFSHORE GRID INTEGRATION

There are number of ways to construct/design offshore grids, depending on the size of wind farms and level of redundancy required. It must be kept in mind that redundancy level depends on economy [4]. The notional designs which are implemented for layout of seaward wind park are mentioned below [4],

### 5.1 Radial design

In radial design several wind turbines are connected in series as its name implies “Radial”. This grid integration is mostly used in small scale offshore wind parks. Design for radial type grid integration is shown in (Fig. 7).

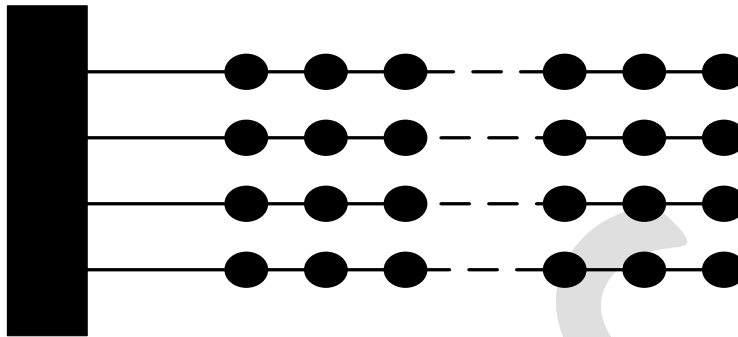

Fig 7. Radial Offshore Grid

### 5.2 Loop design

Design is somehow similar to radial offshore grid, but here redundancy is established between wind turbines. Some versions of loop design offshore grid integration are shown in (Fig. 8, 9).

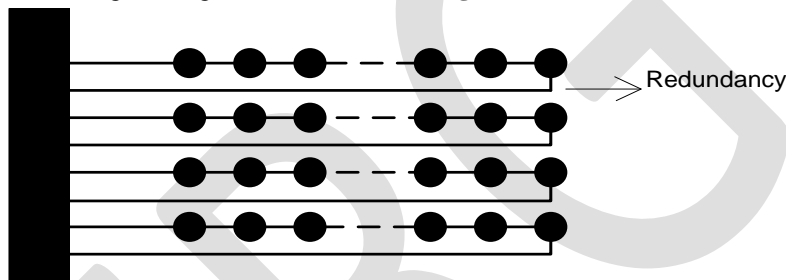

Fig 8. Single sided ring offshore grid

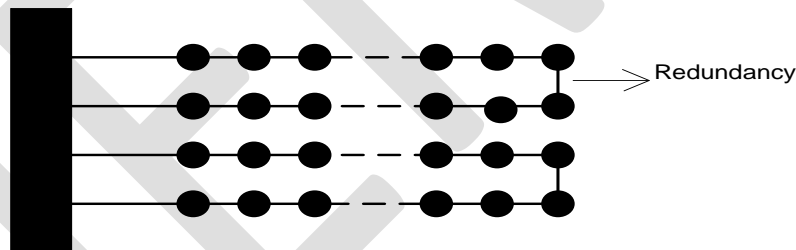

Fig 9. Double Sided ring offshore grid

### 5.3 Star design

Wind turbines are spread over number of feeders. Mainly used to operate equipment with low rating. This system is more reliable because outage of cable affects only one wind turbine and give liberty to use less number of cables. (Fig. 10) shows its practical form.

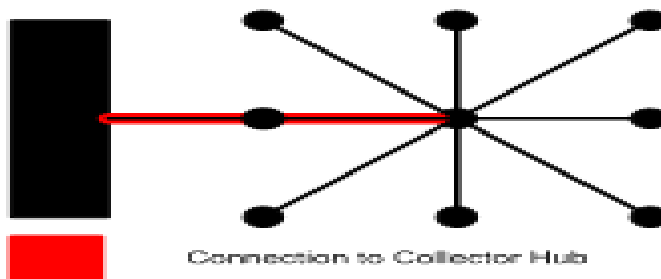

Fig 10. Star offshore grid

## 6. Power Quality Issues in Offshore Wind farm & Their Proposed Solutions

Due to availability of vast area and lack of involvement in human activities, offshore wind parks are growing their root across the globe. In coming future as it is expected that adequate amount of power will be dependent on offshore wind generation, hence such wind farms are under great consideration of concerned authority. Furthermore, to obtain maximum efficiency with minimum cost investment following major issues in offshore wind parks should be analyzed and methods to scour out from these issues must be proposed.

### 6.1 Low voltage ride through (LVRT)

LVRT is the most consistent issue occur in offshore parks in which under low wind pressure condition generators fail to supply reactive power hence power to load end cannot be delivered. (Fig. 11) shows LVRT characteristic curve [5].

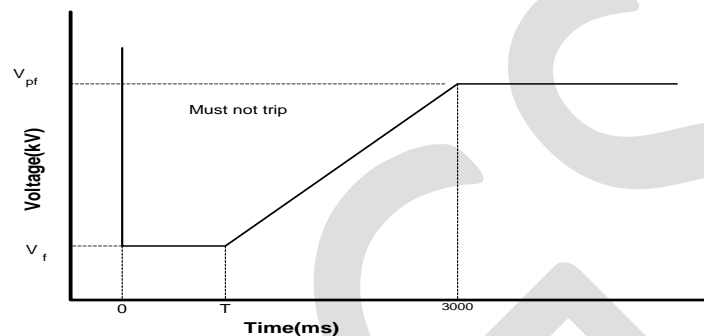

Fig 11. Low Voltage Ride through Characteristic

To increase LVRT capability in generating stations following issues are proposed [6].

- By insertion of chopper resistor in DC links.
- Energy must be dumped in Energy Storage System, like batteries & super capacitors etc.
- Using STATCOM near load centers & reactive power compensator also increase LVRT capability.

### 6.2 Harmonics

The two main causes which produce harmonics in the wind farms are non-linear characteristics of electronic devices and resonance [7]. Harmonics may cause following harmful effects on HVDC transmission system.

Inappropriate heating in transformer and rotating machine, over loading in neutral conductor, transmission lines are over loaded, deterioration of fuses [8]. Following (Table. 1) of IEEE standard 519-1992 suggest limits of total distortion in demand at customer side [9].

Table 1: limit for Harmonic Distortion

Max Distortion of Harmonic Current IL						
Individual Odd Harmonic						
Isc/IL	H<11	11<h<117	17<h<23	23<h<35	35<h	TDD
<20	4.0	2.0	1.5	0.6	0.3	5.0
20<50	7.0	3.5	2.5	1.0	0.5	8.0
50<100	10.0	4.5	5.0	1.5	0.7	12.0
100<1000	12.0	5.5	4.0	2.0	1.0	15.0
>1000	15.0	7.0	6.0	2.5	1.4	20.1
Limit of Even harmonics is 25% of odd Harmonic Limit						
Distortion in Current is Limited in DC offset Not Allowed						
There is a limit for current distortion values in power generation equipment irrespective of actual Isc/IL						
Where,						
Isc = maximum short circuit current at PCC						
IL = maximum demand load current (fundamental frequency component) at PCC						

Solutions for harmonic mitigation are given as under [10]

- In delta-star system neutral of star connection must be ground.
- In delta-delta system secondary delta is ground by using tertiary winding.
- Using Power line Carriers (PLC) separates distinct frequency signals as in de-multiplexing reduce harmonic distortion.
- Using hybrid filters which allow specific frequency signals to pass through them.

### 6.3 Voltage stability

Voltage stability in wind parks is analyzed under following conditions.

- Steady state voltage at the time of generating power.
- Voltage flickers.
  - Fluctuation at time of operation
  - Fluctuation at time of switching

Solutions for voltage stability issue are [11].

- Frequent load flow analysis is required to ensure that system voltage must not go beyond or below the prescribed limits.
- Using SSSC (FACTS) controller near load end overcome the issue of voltage regulation [12].

## 7. SIMULATIONS IN MATLAB-SIM POWER SYSTEMS

### 7.1 Single phase diode bridge rectifier & single phase two pulse IGBT inverter

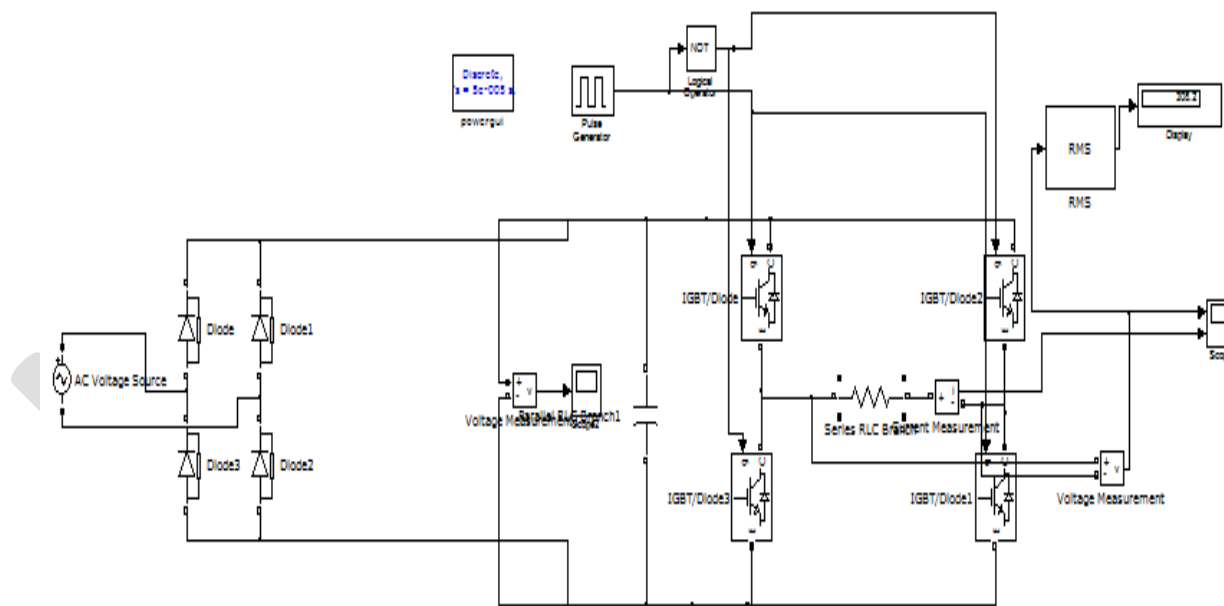
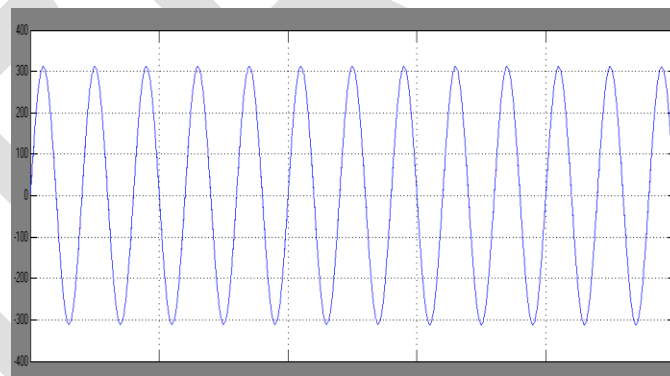

Fig 12: Simulation of VSC-HVDC link

Simulated model at (Fig. 12) shows Ac source of peak voltage 311.127V-50Hz supply is used as an input. This input voltage is fed to single-phase diode bridge rectifier which converts the input Ac to Dc, output obtain from single-phase diode bridge rectifier is 308.2V Dc. After eliminating ripples through capacitor. The Dc from rectifier is fed to inverter which makes peak voltage 308.2V-50Hz square wave Ac.

**Table 2: Obtained Results**

Input Peak Voltage	311.127V Ac
Input RMS Voltage	220V
Input Frequency	50Hz
Output Voltage of Rectifier	308.2V Dc
Output Peak Voltage of Inverter	308.2V Ac
Output RMS Voltage of Inverter	217.5V
Output Peak Current of Inverter	0.6A
Output RMS Current of Inverter	0.43A
Gate Pulses of Inverter	Amplitude=1, Period= 0.02sec Pulse width= 50%, Phase delay= 0sec
Active Power	93.525W
Reactive Power	0 (As load is pure resistive)
Power Factor	1 (Pure resistive load)
Current THD (Total Harmonic Distortion)	48.30%
Voltage THD ( Total Harmonic Distortion)	48.30%
Voltage Drop	2.5V
Voltage Regulation	0.413%



**Fig 13. Rectifier Input Voltage**

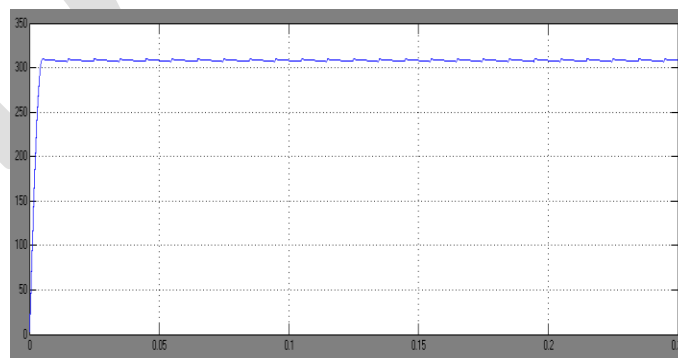

**Fig 14. Rectifier Output Voltage**



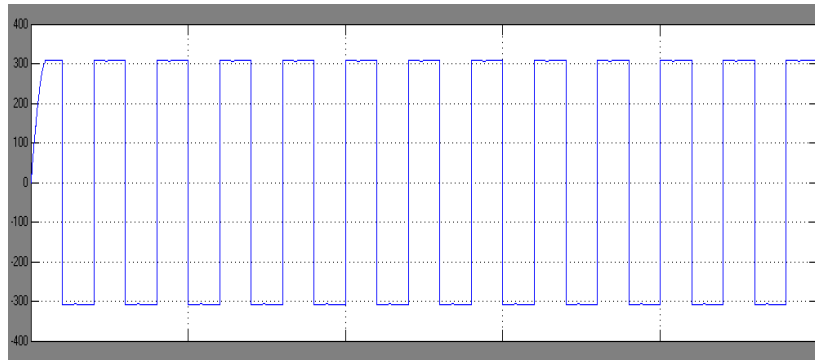

Fig 15: Inverter Output Voltage

### 7.2 Single phase thyristor bridge rectifier & single phase two pulse IGBT inverter

Ac source of peak voltage 311.127V-50Hz supply is used as an input. This input voltage is fed to single-phase thyristor bridge rectifier which converts the input Ac to Dc, output obtain from single-phase thyristor bridge rectifier is 205.8V Dc. After eliminating ripples through capacitor. The Dc from rectifier is fed to inverter which makes peak voltage 205.8V-50Hz square wave Ac.

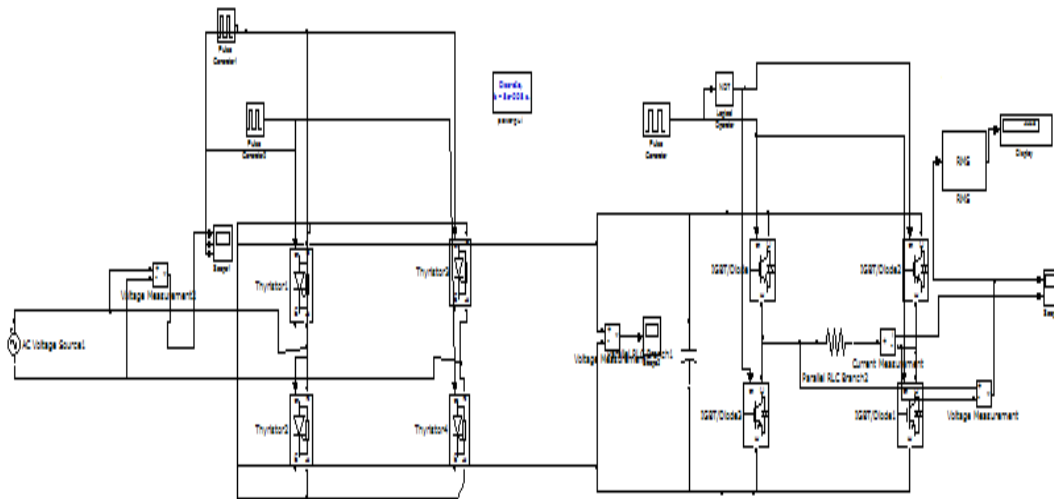

Fig 16. Simulation of LCC-HVDC link

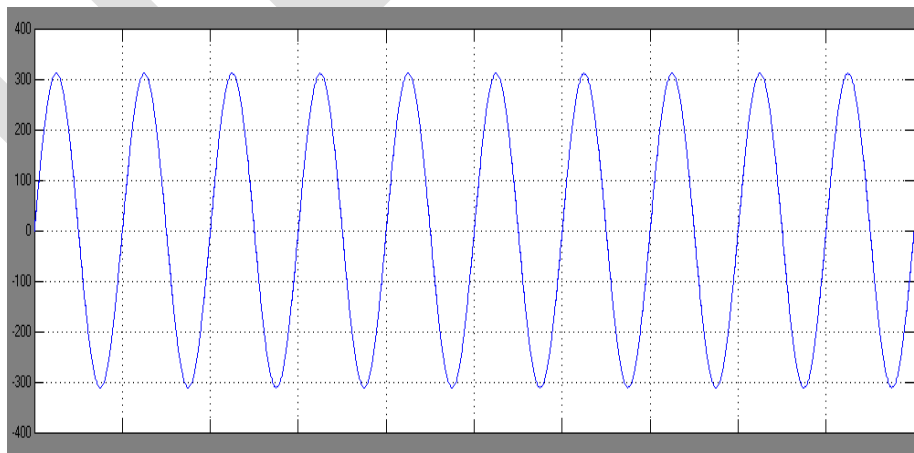
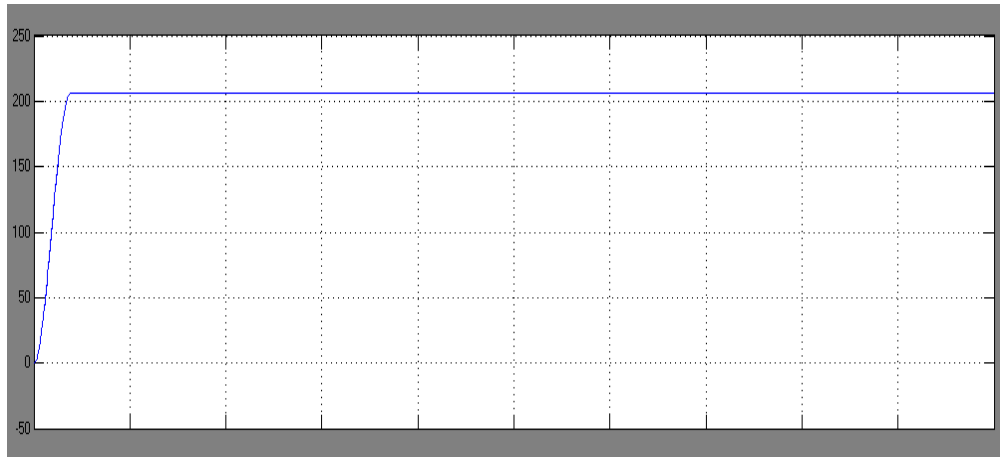
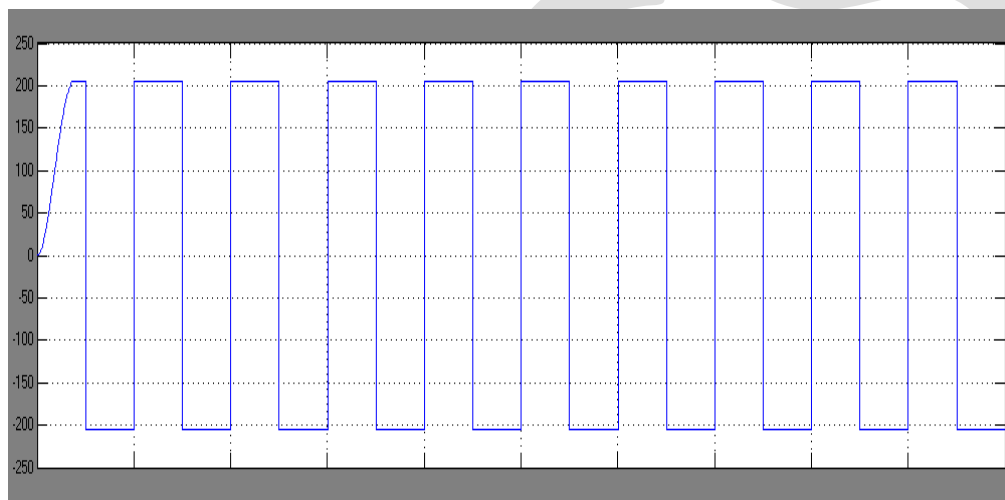

Fig 17. Rectifier Input Voltage



**Fig18. Rectifier Output Voltage**



**Fig 19. Inverter Output Voltage**

Table 3. Obtained Results

Input Peak Voltage	311.127V Ac
Input RMS Voltage	220V
Input Frequency	50Hz
Output Voltage of Rectifier	205.8V Dc
Output Peak Voltage of Inverter	205.8V Ac
Output RMS Voltage of Inverter	145.2V
Output Peak Current of Inverter	0.42A
Output RMS Current of Inverter	0.15A
Gate Pulses of Inverter	Amplitude=1, Period=0.02sec Pulse width= 50%, Phase delay= 0sec
Gate Pulse of Thyristor 1 &4	Amplitude=1, Period=0.02sec Pulse width= 10%, Phase delay= 0.01sec
Gate Pulse of Thyristor 2 &3	Amplitude=1, Period=0.02sec Pulse width= 10%, Phase delay= 0sec
Active Power	21.78W

Reactive Power	0 (As load is pure resistive)
Power Factor	1 (Pure resistive load)
Current THD (Total Harmonic Distortion)	48.34%
Voltage THD ( Total Harmonic Distortion)	48.34%
Voltage Drop	74.8V
Voltage Regulation	4.686%

### 7.3 Connection and inversion of two (50 hz & 60 hz) single phase ac schemes to 220 v, 50 hz output

Simulation shown in (Figure 20) consists of two different Ac sources with the same voltage ratings of 220V- Ac but with different frequencies (50 Hz and 60 Hz) respectively. The output from each Ac source is rectified by using diode bridge rectifier. Ripples are removed by the help of two parallel connected capacitors. Then the rectified powers from rectifier are coupled and supplied to the IGBT based inverter, which produces an output 220V and 50Hz Ac.

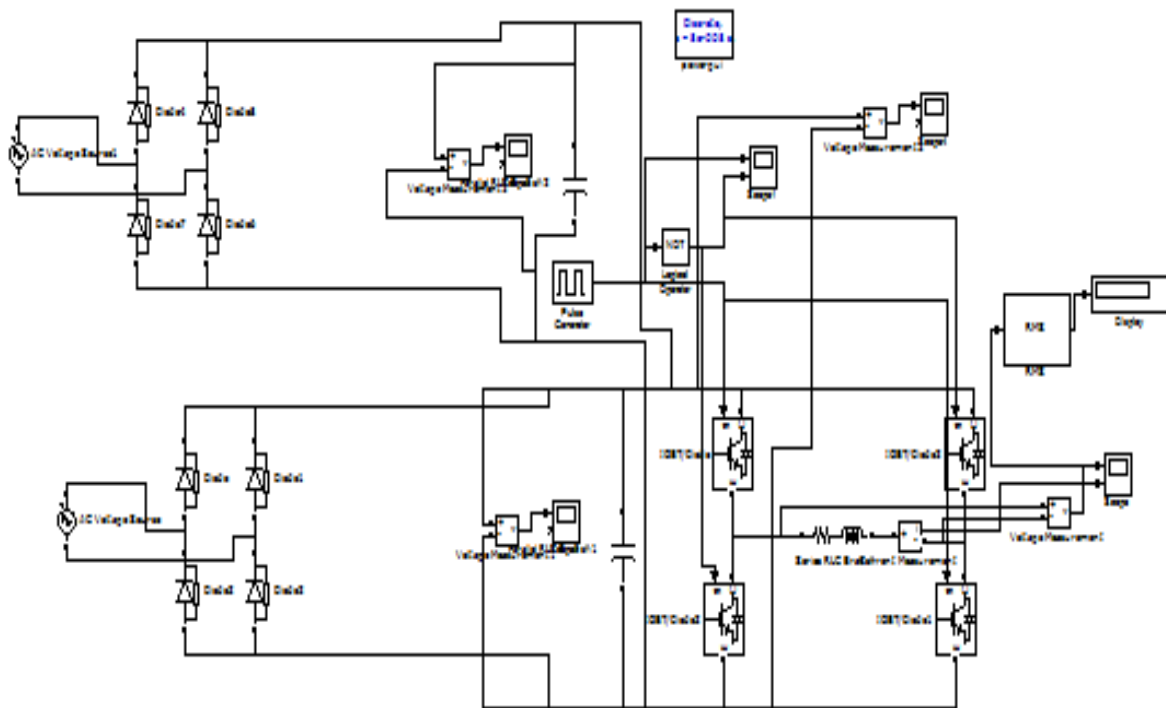

**Fig 20.** Connection and Inversion of two (50 Hz & 60 Hz) single phase Ac schemes to 220V, 50 Hz output

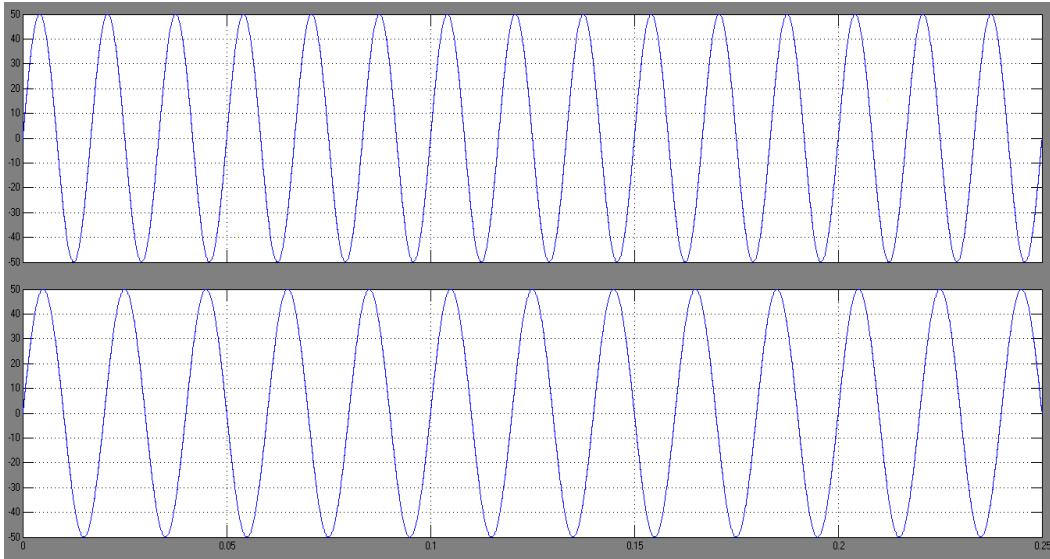

**Fig 21.** Two ACs 220V 50 Hz and 220V 60Hz

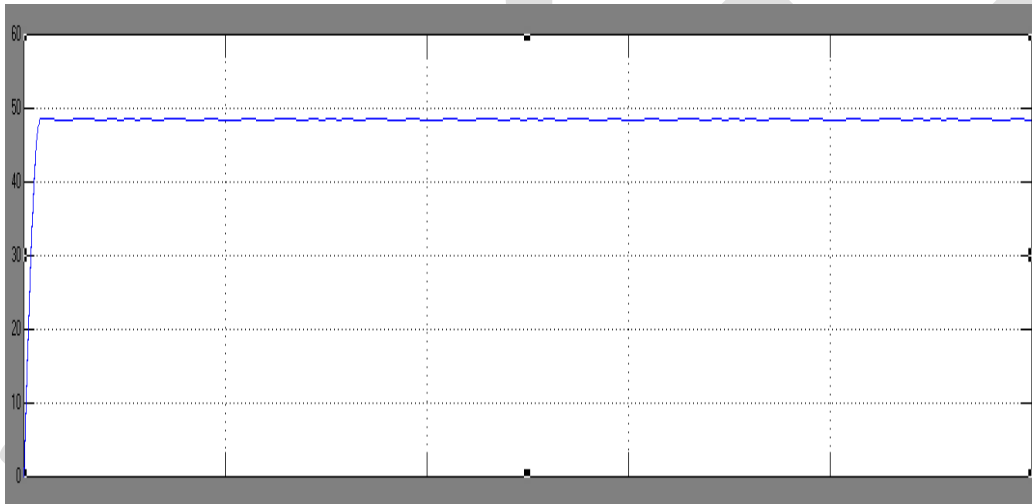

**Fig 22.** Rectifier Output Voltage

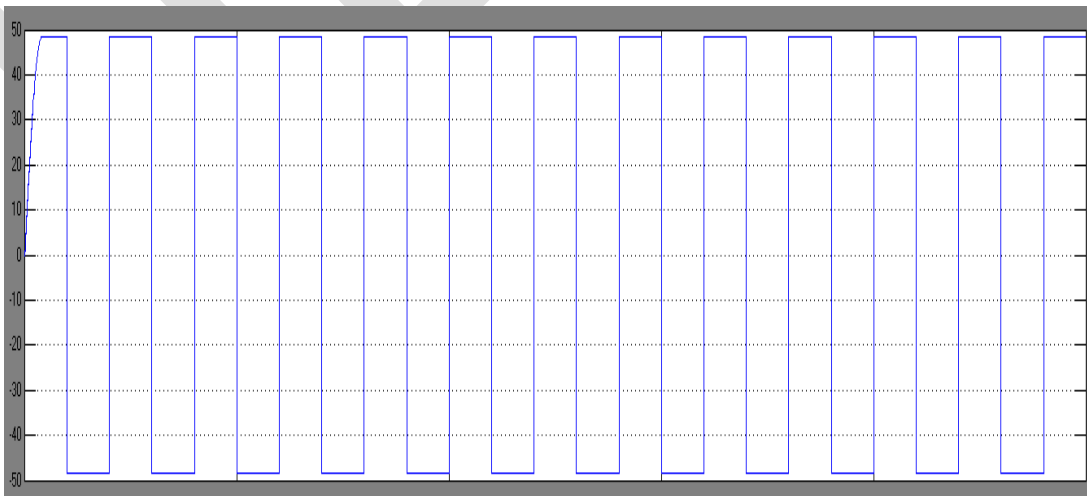

**Figure 23.** Inverter Output Voltage

## 8. ACKNOWLEDGMENT

The Authors are highly thankful to Of Electrical Engineering, Mehran University of Engineering and Technology, Jamshoro; for providing concerned research resources.

## 9. CONCLUSION

After study in every perspective of offshore HVDC based wind farms. We come to conclude that as Pakistan is coasted with Arabian Sea, thus we have an ample space to install IPPs (Independent Power Plants) within our premises. Moreover, two distinct and most extensively used converter technologies (Voltage Source Converter & Line Commutated Converters) are compared and suitable HVDC transmission scheme is proposed on the basis following parameters.

- Voltage Regulation
- Voltage Drop
- Total Harmonic Distortions
- Control Strategy
- Pulse generator
- Reactive Power Control

Considering all above mentioned parameter VSC-HVDC transmission system is found to be more feasible in both aspects (economically and technically). On the basis of modern developments VSC based transmission system is considered as the most convenient and functional way for HVDC transmission as well as for asynchronous tie lines. Though for higher voltage transmission system, VSC based Dc transmission schemes are not preferred due to high economic factor. But the high level of controllability is the main reason for its adaptation.

At last, the interconnection of two Ac power sources with the voltage level of 220V and frequencies of 50Hz & 60Hz respectively using VSC based HVDC link is shown in fig 20. Using VSC-PWM based HVDC link enables the entire control on the flow of power as well as on the reactive power and grant full control in independent dynamic voltage. For the purpose of black start back-to-back converters are used. VSC based system is the most favorable and simple tool for the interconnection of two power systems. Furthermore, using this technology the power transfer control is made possible and even more sophisticated.

## REFERENCES:

- [1] University of Delaware, College of Earth, Ocean & Environment. Mapping the Global Wind Power Resource. Report issued by NASA/SSE.
- [2] Sørensen, P., Cutululis, N. A., Lund, T., Anca, D., Sørensen, T., Hjerrild, J., ... Kræmer, H. (2007). Power Quality Issues on Wind Power Installations in Denmark, 3–8.
- [3] HVDC Power Transmission Systems Technology & System Interactions, By K.R.Padiyar Indian Institute of Science Banglor
- [4] Hansen, T. H. (2009). Offshore Wind Farm Layouts, (July).
- [5] Huang, H. M., Chang, G. W., Chen, C. K., Su, H. J., & Wu, T. C. (2011). A study of low voltage ride-through capability for offshore wind power plant. *2011 IEEE International Conference on Smart Grid Communications (SmartGridComm)*, 517-521.
- [6] Hasegawa, N., & Kumano, T. (n.d.). Low Voltage Ride-Through Capability Improvement of Wind Power Generation Using Dynamic Voltage Restorer 2 Application of DVR to Wind Power System. *Energy & Environment*, 166–171.
- [7] Miao, Y. (2010). The impact of large-scale offshore wind farm on the power system. *Electricity Distribution (CICED), 2010 China International Conference on*, (1671), 1–5.
- [8] Chen, Z. (2005). Issues of connecting wind farms into power systems. *Proceedings of the IEEE Power Engineering Society Transmission and Distribution Conference, 2005*, 1–6.
- [9] Schneider-Electric. (2014). IEEE Standard 519- 2014, 50.

[10] Sandoval, G., & Houdek, J. (2005). A Review of Harmonic Mitigation Techniques, 1–17.

[11] Martins, M. (2006). Voltage Stability Issues Related to Implementation of Large Wind Farms by Marcia Martins.

[12] Transmission, I. N. P. (2007). *Facts Controllers in Power Transmission. Powe by KR. Padiyar.*

IJERGS