

Aneta Tor-Świątek

Lublin University of Technology, Department of Polymer Processing
36 Nadbystrzycka Str., 20-618 Lublin, a.tor@pollub.pl

INNOVATIVE HYBRID POLYMER COMPOSITES CELLULAR POLYMER-METAL POWDER OBTAINED IN EXTRUSION PROCESS

Abstract

Polymer matrix composites used for different cable coatings or pipes, are fabricated from materials containing various kinds of powder fillers or fibrous. Properties and structure of these materials depend on the type of added ingredients, their miscibility and quantity. Proper processing method also plays an important role, which allows for obtaining products of homogeneous reproducible properties. The composition was prepared by extrusion with changed processing parameters according to solid plastics. The roughness of obtained shapes was measured with the use of linear method. Results shows that adding blowing agent has a significant influence on mechanical properties.

Key words

extrusion, poly(vinyl chloride), blowing agent, metal powder, composite

Introduction

The extrusion process of polymer materials has been extensively researched. However, as a result of constant improvements to this process, as well as changes and modifications of polymer material, it is vital to analyse the influence of this modification on the processing itself, as well as on the characteristics and structure of the obtained products. Widely used thermoplastic polymer materials such as LDPE, HDPE, PP, PS, PVC contain various types of additives to change their characteristics [1, 2, 3]. Some of the most often used additives are: fillers, nucleating agents, anti-adhesive agents, and retardants.

Among these agents there are also porous agents and microporous agents (blowing agents), in which the structure of the polymer changes as a result of the emission of gas products during the processing. Porous agents used in polymer processing are categorized usually into physical and chemical ones. This categorisation is based on the way the porous gas is emitted [4]. Physical porous agents (physical blowing agents) during the blowing process do not change their chemical structure, but only their state of matter. Thus, these are liquids or gases dispersed under pressure in a polymer material, which after raising the temperature and lowering the pressure evaporate or are liberated in the form of bubbles. This group includes organic liquids with low boiling point: mostly aliphatic compounds and their chlorine and fluorine derivatives. Chemical porous agents (chemical blowing agents) operate in a way similar to physical blowing agents, but gas products causing blowing are created of their dispersion in the polymer. They can be divided into inorganic and organic. Inorganic blowing agents are mostly certain carbons and hydrocarbons, for instance sodium hydrogen carbonate. At elevated temperatures they are decomposed with liberation of gas, usually CO₂ and NH₃. Organic blowing agents are currently the most important group of chemical blowing agents used in the extrusion of polymer materials. They belong to several groups with different chemical structure. They are, inter alia: azo compounds, hydrazine derivatives, semicarbazides, azides, N-nitroso compounds, triazoles, tetrazoles and urea derivatives. The most important of those is an azo compound, diamide of azo-formic acid, azodicarbonamide. These blowing agents have a wide range of decomposition temperature and the amount of the emitted gas [5].

Blowing agents used in the blowing process of polymers have either exothermic or endothermic distribution characteristics. However, the agents used until now in the extrusion process have exothermic distribution characteristic. The initiated distribution of the blowing agent is automatic, even after cutting off the energy supply. Therefore, porous products produced with the use of such agents have to be cooled to prevent deformation and to maintain appropriate porous structure. The main representatives of this group are hydrazides, e.g. sulfohydrazide, and azo compounds, e.g. azodicarbonamide [2, 5].

Commonly used blowing agents may take the form of a solid (powder, granulate), liquid or gas. However, the use of a chosen blowing agent determines the selection of the appropriate processing methods and the ele-

ments of technological line. The extrusion process in which a blowing agent or a microblowing agent is added to the polymer material is called respectively foam extrusion and micro-foam extrusion. An agent causing a modification both in the extrusion process and in the extrudate can be added to the polymer during its processing or during its production.

As a result of modification of a polymer material with a blowing agent, substantial changes are observed in the characteristics of both the processing and in the structure and characteristics of the obtained products. The resulting changes may be of a different nature and depend on many factors, such as particular conditions of the processing, the type of polymer material used in the process, the type and the content of the modifier – blowing agent, elements of machines and equipment used in the processing [6]. Auxiliary agents in the form of powders are added to polymers to improve the mechanical, dielectric, thermal, chemical or processing properties (better flow, reduced processing shrinkage). These agents primarily include: calcium carbonate, magnesium oxide, beryllium oxide, talc, chalk, and oxides of metals (aluminum, brass, nickel, copper and iron). The addition of metal powders to a polymeric material results in a significant change in its characteristics and structure. The addition of aluminum and brass enhances acoustic conductivity, nickel powder increases impact resistance, and copper improves thermal stability.

Polymer composites, type polymer-metal, may take different forms; inter alia, we can distinguish layered composites – laminates, porous or conductive. Their form depends mainly on the manufacturing process, primarily by injection molding or laminating [7]. Mixing metal materials with polymer ones brings with it many benefits. Obtained products are characterized by a simplified construction and reduced weight, which affects the increase in efficiency and reduction of costs [9]. Hybrid polymer composites containing metal powders are gaining attention due to their novel properties, such as efficient screening of the magnetic field. Furthermore, they are characterized by low specific gravity, resilience to corrosion, flexibility and ease of processing. In the work [12][13] an analysis of the properties of polymer composites containing copper powder or flakes was conducted. The electromagnetic properties and the structure of the obtained composites were established. In the study, materials such as EVA, LDPE, LLDPE, PP and PVC were used as the polymer matrix. Studies have shown magnetic permeability of value less than 1 and large dielectric permeability. It has been shown that two-layer composites have the best shielding properties.

Composites obtained by a team from the Israel Institute of Technology [8] included microparticles of Al, Ag and Ni in polymer matrix made of low-density polyethylene, and thermoplastic elastomer. Obtained composites were injected and then their mechanical and tribological properties and their structure were analysed. In the analysed solution the polymer matrix was solid throughout. The study showed a significant effect of hardness, elastic modulus, dynamic friction and state friction with the increasing content of individual metal powders. However, at the smallest metal content (2% wt.) there was a decrease in the tested properties, and with further increase of the amount of metal in the material, the tested properties' values were increasing. The analysis of the literature revealed that studies of polymer compositions containing metals concern only the solid polymer materials, not porous ones [9, 10, 11]. In all analyzed cases the added metal had the form of fibres, not powder and was produced in the process of injection molding or galvanization, not twin-screw extrusion [11, 12]. The addition of the metal powders results in obtaining new products with new, special properties like electrical, thermal and magnetic conductivity, as well as reduced wear. In addition, an increase in the barrier and strength properties, such as hardness or tensile strength was observed [13].

The main goal of this work is closer investigation of the effect of modification of poly(vinyl chloride) plasticized, with selected special blowing agent and metal powders on the course and efficiency of the extrusion process, the selected properties of the resultant porous extrudate and on its structure. A further aim of this work is to obtain an extrudate in the form of tubes with porous structure and satisfactory physical properties, relevant geometrical features, as well as meeting the requirements of the market. These objectives will be achieved through experimental research process of extrusion blowing of poly(vinyl chloride) plasticized and experimental studies of selected properties and characteristics of this material.

Experimental studies

The process of extrusion blowing of poly(vinyl chloride) modified blowing agent and metal powder was carried out on a laboratory pipe extrusion process line. The applied technological line was equipped with a single screw extruder T-32-25 with variable screw rotation speed, extruder head and standard auxiliary equipment (cooling device in the form of a cooling bath and a receiving device). The study used straight spindle extruder head for

pipe extrusion, the appearance and diagram of which are shown in Fig. 1. The extrusion head used was dedicated to obtain shapes with open and closed sections, such as mainly struts and pipes. The nozzle used in research, and is characterized by an outer diameter of 19.5 mm and a channel diameter of 13.5 mm inner channel. The process used the classic screw intended for the processing of poly(vinyl chloride).

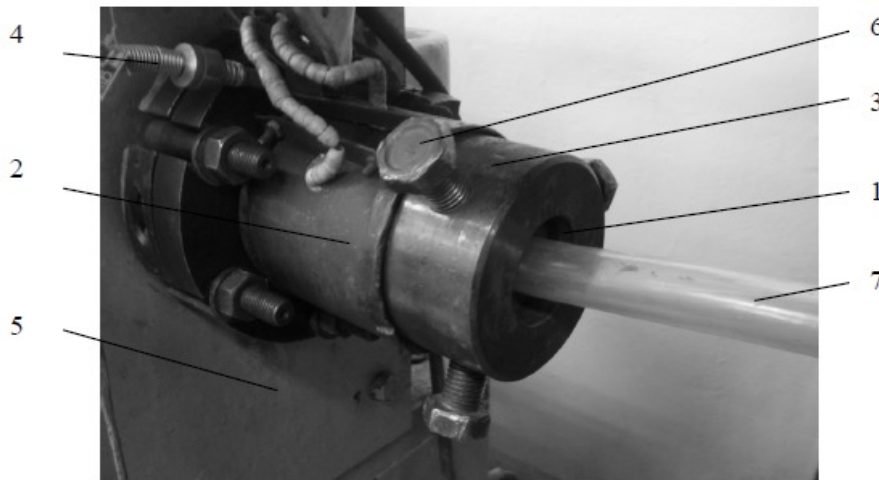

Fig. 1. View of extruder head: 1 - body of the nozzle head, 2 - heater ring, 3 - head body, 4 - temperature sensor, 5 - fragment of the extruder plasticizing unit, 6 - adjustment screws nozzle body 7 - formed pipe

Source: author's own work

Prior to the experimental process, the temperature was adjusted within a zone of the plasticizing unit and extrusion head by means of automatic control, in which the extruder is equipped with a T-32-25. The values that are matched to the temperature processed poly(vinyl chloride) and a blowing agent used based on the manufacturer of the material and blowing agent and the results of preliminary exploratory studies. The temperature in the individual zones of the plasticizing unit was appropriate, in accordance with the program of research: 110, 120, 140 and 140°C, while the temperature in the extrusion head equalled to 160°C. Microcellular extrusion process was initiated at stabilizing the distribution of the set temperature. A process was carried out at a screw rotation of 50 rpm.

The investigation of selected mechanical properties of the obtained section was conducted using strength testing machine Zwick Roel Z010. It was assumed that the speed of stretching was 50mm/min and was constant during the experiment. The temperature was 23°C, and the mean humidity 50%.

The roughness of the surface layer was examined with the use of linear method. The roughness testing was conducted using a TR200 profilometer with an in-built detector and specialised software. This is a contact device comprising a measuring head ended with probe, mapping linear profiles of tested samples. Research was executed according to standard PN-EN ISO 4287:1999.

In experimental studies the following factors was research:

- temperature distribution T1, T2, T3, T4, T5, at certain points along the plasticizing unit of the extruder and along the extrusion head, °C
- rotational speed of the screw u , s-1
- type of coolant,
- the coolant temperature t , °C
- D_w diameter measurement samples, mm
- D_d nozzle diameter of the head, mm
- length L of sample measurement, mm
- force F_r when picking measurement samples, N
- initial area A_0 -sectional area of measurement samples, mm²
- Δl_r increase in the length measurement section at a breaking point measurement samples, mm
- initial length l_0 samples measuring section, mm
- arithmetic mean deviation of the profile R_a , μm
- maximum height of the profile R_y , μm

- maximum depth of the profile peak R_m , μm
- profile asymmetry S_k ,
- sum of the maximum peak height R_t , μm
- average spacing of individual peaks of the profile S , mm
- maximum height of the profile above the average line of the measuring section R_p , μm
- average spacing of the profile spread S_m , mm

As an indirect result the following factors were considered:

- ρ_n normal density measurement samples, kg/m^3
- porosity SP measurement samples, %
- tensile strength σ measurement samples, MPa
- elongation at break ϵ_r measurement samples, %
- Barus effect of β , %

For those modifiers based on:

- blowing agent content in the material, %
- iron content in the material, %
- copper content in the material, %

The numerical values of variable factors are summarized below.

As permanent factors, the following were considered:

- material tested – poly(vinyl chloride) plasticized.
- way of proportioning of blowing agent,
- structural elements of the plasticizing unit, tray, extrusion head and other components of cellular extrusion process line.

The study may also present other factors such as variable: power voltage, humidity, and ambient temperature. It is estimated that the impact of changes in these factors on the results of studies is very small and can be omitted without detriment to the work. The research used plasticised PVC with trade name GFM Alfavinyl GMF/4-31-TR in the form of granules and the endothermic blowing agent Hydrocerol 730 in granulated form. The content of the blowing agent was 0%, 0.5% and 0.5% wt. PVC was also modified with powder of iron Fe and copper Cu in the amount of 0%, 1.5% and 3%. Metal powder had irregular forms, granulation in the amount of 45-60 μm and bulk density 1660 – 3200 kg/m^3 .

Results

As a result of the research, an open profile was obtained (fig. 2) with a diameter of 18.20 mm and thickness of 3.42 mm, which was tested on selected physical and mechanical properties. The physical and geometric structures of the profile's surface were also analysed. Fig. 3 shows morphology of obtained extrudate containing 0.5% of blowing agent and 1.5% of Fe and Cu powder.

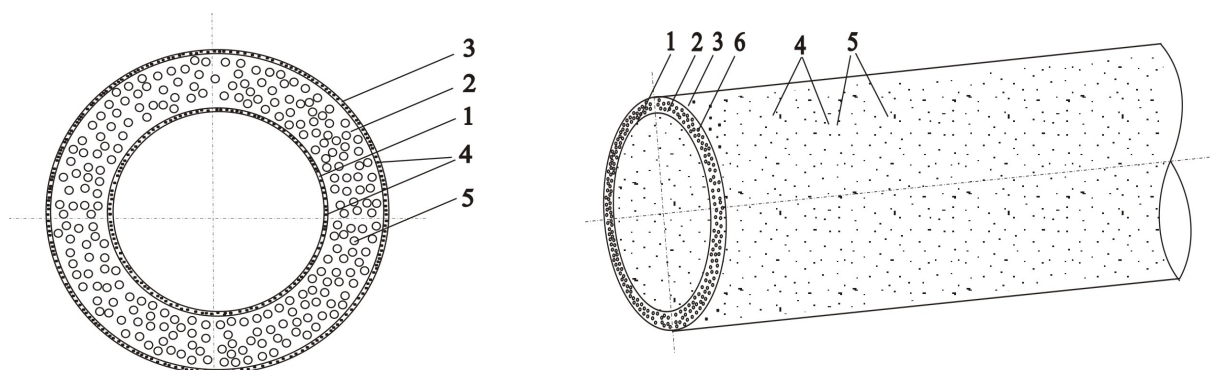
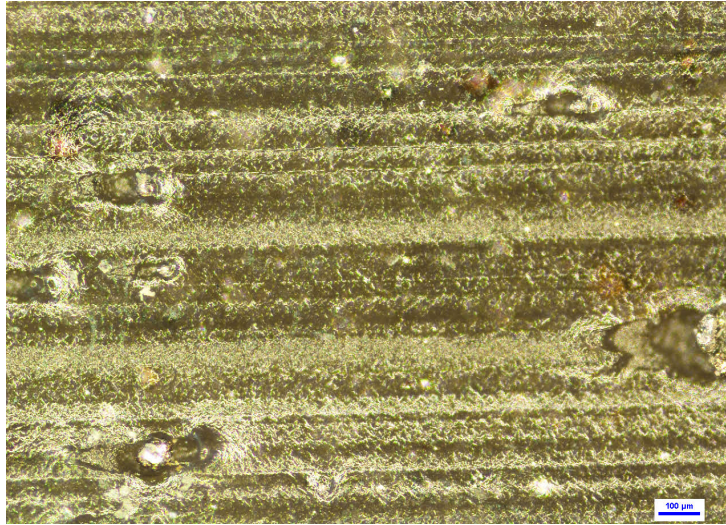

Fig. 2. Scheme of hybrid extrudate: 1 – inter layer with metal powder, 2 – middle cellular layer (with blowing agent), 3 – outer layer, 4 – metal particles, 5 – pores.

Source: own Polish patent applications n. 402486 and 402487]

a)



b)

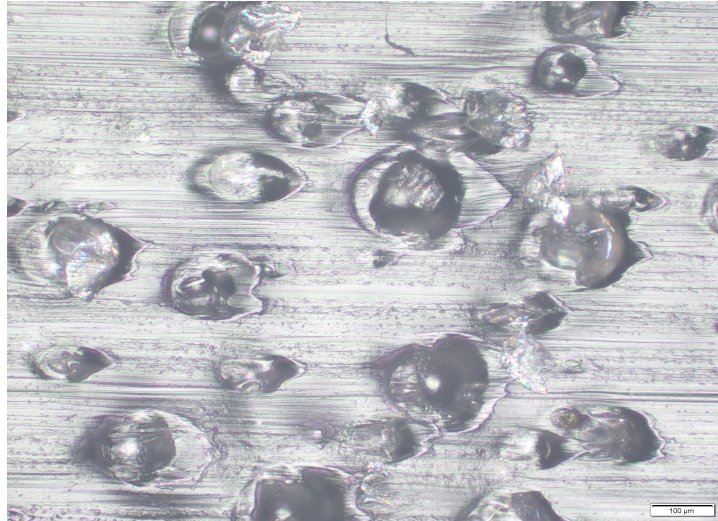

Fig. 3. View of the extrudate morphology: a) outer layer containing metal particles, b) middle cellular layer containing blowing agent

Source: author's own work

The obtained section is characterized by a uniform distribution of blowing agent in the entire cross-section of the extrudate. The created pores have different diameters, which could have been caused by uneven cooling of the extrudate during the extrusion process. The addition of fillers in the form of iron and copper powder caused a creation of a metallic glossy coating on the inner and outer surfaces of the profile.

A preliminary analysis of surface geometry revealed significant changes in surface roughness of the obtained extrudate. The conducted study of characteristics of the geometric surface included measurements of surface roughness parameters, i.e. R_a , R_m , R_y , R_p , R_t , R_q , S and S_m . The results are summarized in Table 2. The results of the tests also include profiles of the individual samples shown in Fig. 4.

a)

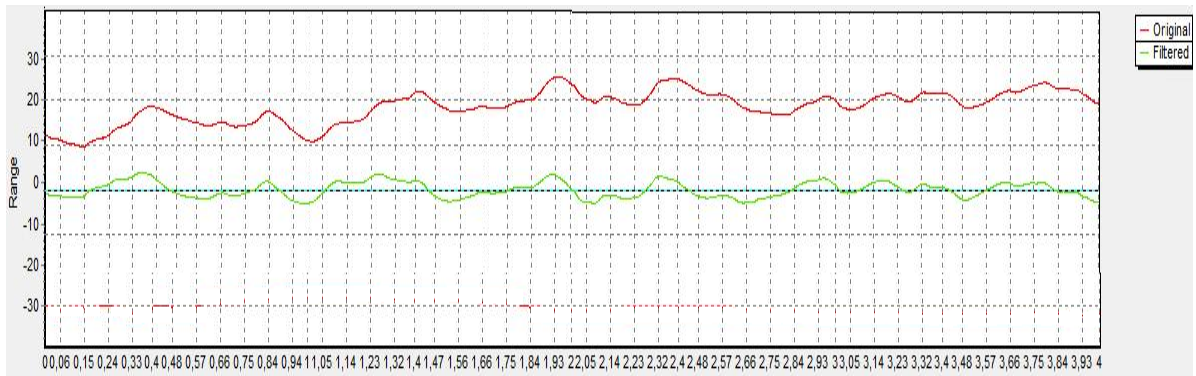

b)

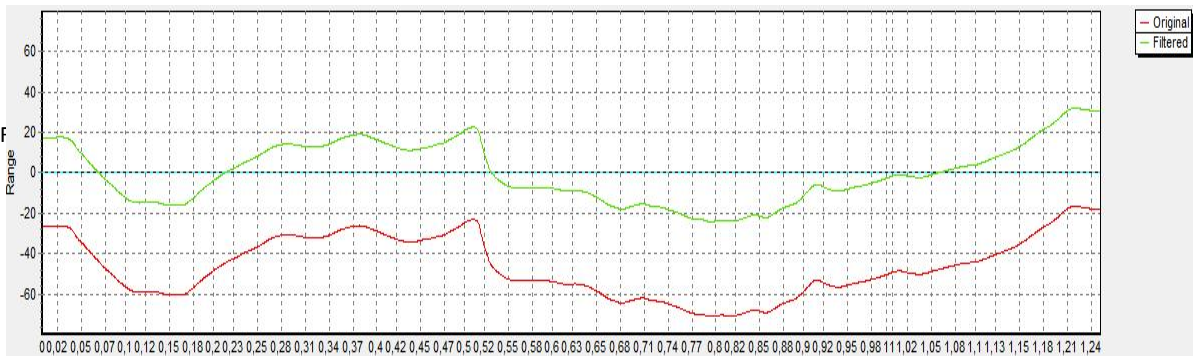

c)

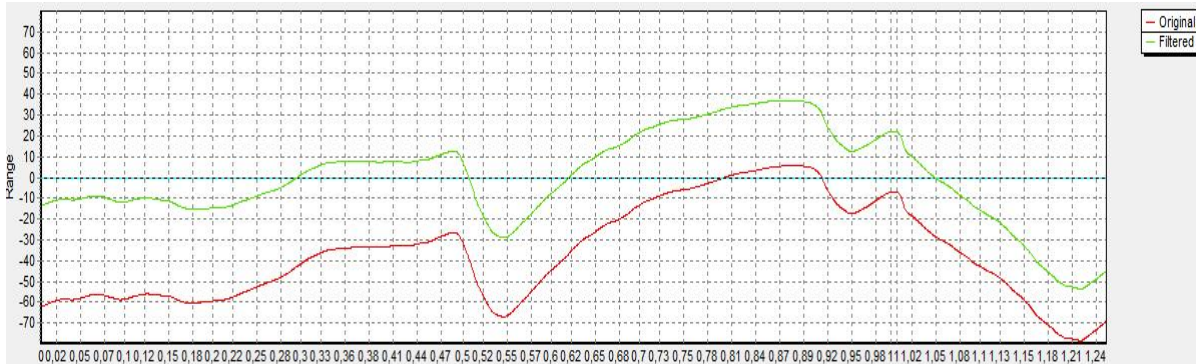

Fig. 4. Profiles of extrudate surface roughness for: a – solid sample, b – sample with 0.5% of blowing agent, c – sample with 0.8% of blowing agent
 Source: author's own work

Table 2. Results of roughness measurement

Sample series	Ra [μm]	Ry [μm]	Rm [μm]	Sk	Rq [μm]	Rt	S [mm]	Rp [μm]	Sm [mm]
I	0.281	1.228	0.611	0.230	0.327	2.380	0.307	0.615	0.5714
II	13.130	32.000	15.760	0.207	15.02	57.750	0.208	19.230	0.6250
III	18.550	42.400	22.000	-0.440	20.49	93.000	0.625	20.390	0.6250

Source: Author's

The results showed a significant effect of added fillers on the geometrical structure of the surface. Comparing the roughness values presented in Table 2 the extrudates from solid PVC and the extrudates from PVC with 0.5% of additive, the increase in the roughness parameter Ra differs considerably. Also, when comparing extrudates from PVC with the addition of blowing filler, the values of surface roughness Ra increase by approx. 56%. Changing the roughness parameters is preferred for adhesive joints. Then, there is no need for additional measures to enhance the adhesion on the surface of the material.

The resulting section was tested on its physical characteristics, among others density, porosity, water absorption, and mechanical characteristics, such as tensile strength, elongation at break, tensile impact, hardness. The results of selected mechanical properties are shown in Fig. 5 – 8.

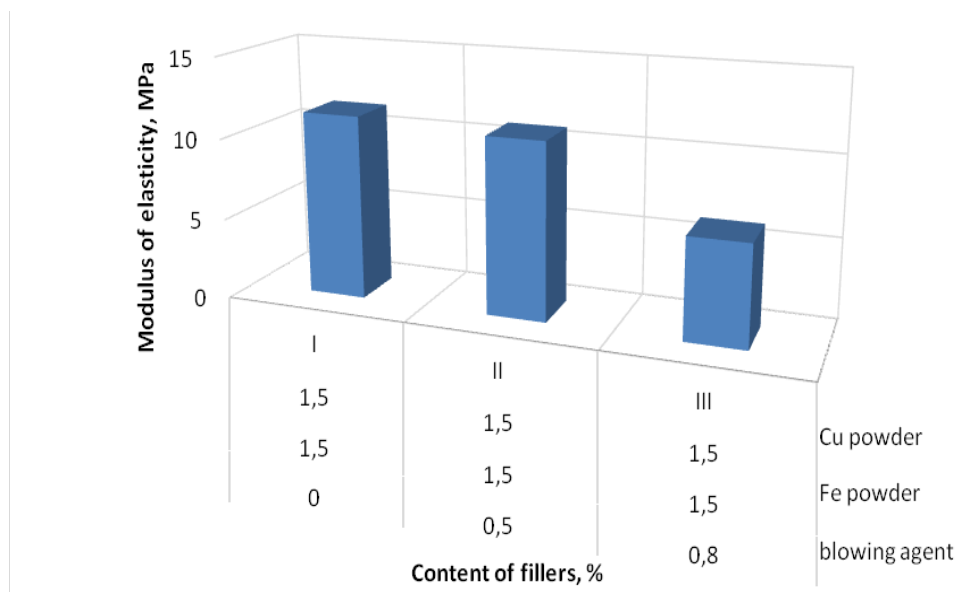

Fig. 5. Dependence of modulus of elasticity on content of fillers

Source: author's own work

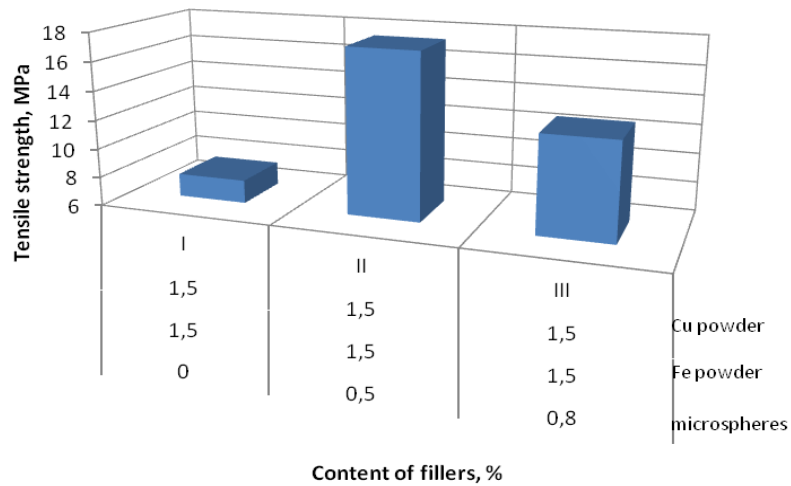

Fig. 6. Dependence of tensile strength on content of fillers

Source: author's own work

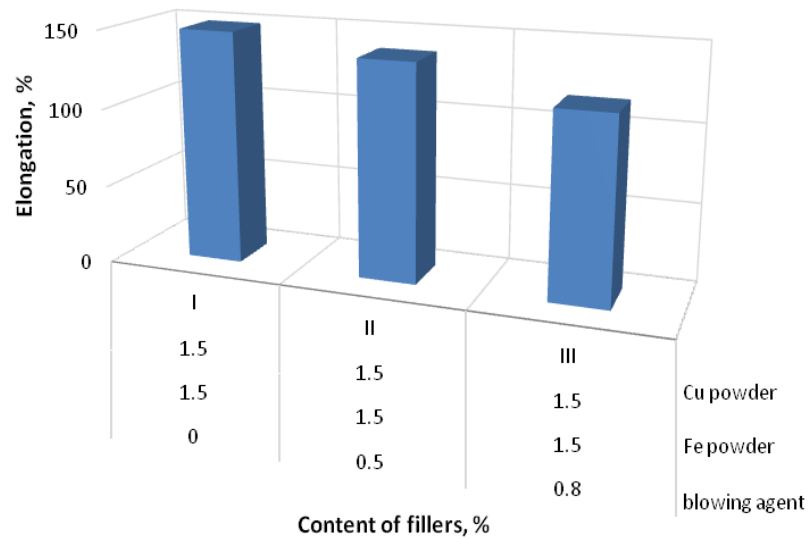

Fig. 7. Dependence of elongation on content of fillers

Source: author's own work

As a result of the modification of poly(vinyl chloride), there was also a change in tensile strength of the tested extrudate. As a result of addition of the blowing agent, strength of the porous pipes decreased by an average of 20% for dosing 0.5% and of 50% for dosing 0.8%. A greater decrease in tensile strength is observed during the addition of copper powder, slightly lower as a result of modification of iron powder. Modification with the use of the blowing agent causes a significant reduction in the mass of the extrudate, and thus increasing its porosity. As a result of modification, the greatest porosity is 25% for the content of the agent in an amount of 0.8%.

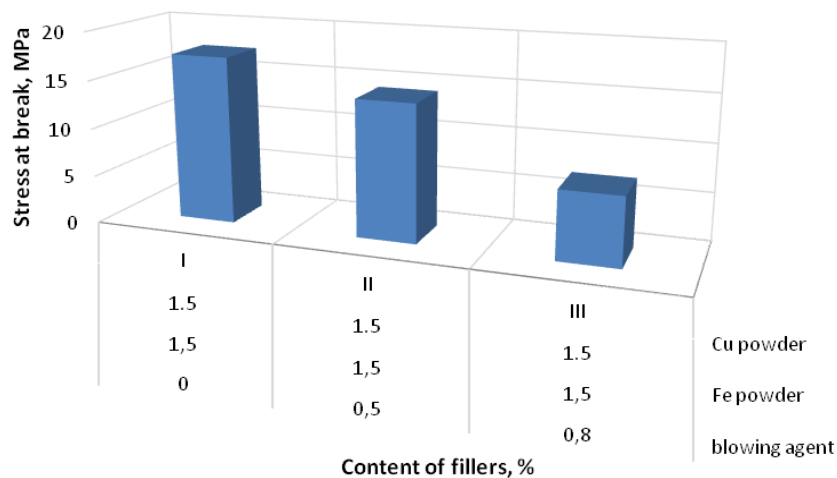

Fig. 8. Dependence of stress at break on content of fillers

Source: author's own work

Summary and conclusions

Studies have shown that the described modification with a blowing agent results in a change in a pipe structure of poly(vinyl chloride) from a solid to cellular only in the inner layer of the pipe, i.e. in its core. In contrast, the addition of filler in the form of copper and iron powders modifies the outer surface of the pipe; however, a larger sedimentation of metal powder occurs on the inner surface of the extrudate. The lowering of the mass of the section by the addition of the blowing agent significantly lowers the wear of the polymer. The resulting hybrid section has modified properties, such as density, strength, roughness, which can be used in fermenters of dairy wastewater treatment plants. Furthermore, the addition of metal powder makes the product quickly identifiable using detectors or defectoscopes. Obtained results revealed changes in selected properties of the extrudate. These changes also occurred in the composites morphology. It caused necessity of conducting studies of physical structure and electrical properties.

References

- [1] L. Markovocova, M. Chalupova, E. Simigova, Magnetoce kompozity s polymernou matricou, *Materialove Inzinierstvo*. 10 (2003) 55-62.
- [2] T. Jachowicz, R. Sikora, Methods of forecasting of the changes of polymeric products properties, *Polimery*. 51 (2006) 177-185.
- [3] T. Klepka, H. Dębski, H. Rydarowski, Characteristic of high-density polyethylene and its properties simulation with use of finite element method, *Polimery*. 54 (2009) 668-672.
- [4] A. Tor-Świątek, Evaluation of the effectiveness of the microcellular extrusion process of low density polyethylene, *Eksploatacja i Niezawodność – Maintenance and Reliability*. 15 (2013) 225-229.
- [5] A. Tor-Świątek, J.W. Sikora, Effect of poly(vinyl chloride) modification with microspheres on geometric structure of extrudates, *Przemysł Chemiczny*. 92 (2013) 538-541.
- [6] T. Garbacz, Structure and properties of cellular thin-walled cable coatings, *Polimery*. 57 (2012) 91-94.
- [7] E. Malone, H. Lipson, Freeform fabrication of ionomeric polymer-metal composite actuators, *Rapid Prototyping Journal*. 12 (2006) 244-253.
- [8] W. Brostow, A. Buchman, E. Buchamn, O. Oleja-Mejia, Microhybrids of metal powder incorporated in polymeric matrices: friction, mechanic behavior and microstructure, *Polymer Engineering and Science*. 48 (2008) 1977-1981.
- [9] K.E. Oczóś, Kompozyty włókniste – właściwości, zastosowanie, obróbka ubytkowa, *Mechanik*. 81 (2008) 579-592.
- [10] P. Łoś, A. Łukomska, S. Kowalska, R. Jeziórska, J. Krupka, Właściwości kompozytów polimerowych z udziałem proszków lub płatków miedzi jako napełniaczy, *Polimery*. 57 (2012) 338-346.

- [11] O. Trzaska, A. Dimitruk, Ł. Kornacki, J.W., Kaczmar, Połączenia hybrydowe polimer-metal wytwarzane w technologii wtryskiwania, *Tworzywa Sztuczne w Przemysle*. 28 (2015) 78-81.
- [12] R. Wróblewski, L. Nakonieczny, J.W. Kaczmar, Elementy hybrydowe typu metal – tworzywo polimerowe wytwarzane metodą wtryskiwania, *Tworzywa Sztuczne i Chemia*. 3 (2008) 94-97.
- [13] D.R. A. Cluff, S. Esmaili, Compressive properties of a new metal-polymer hybrid material, *Journal of Material Science*. 44 (2009) 3867-3876.