

HYDRODYNAMIC EFFECTS IN COMMON RAIL FUEL SYSTEM IN CASE OF MULTIPLE INJECTION OF DIFFERENT FUELS

*Mikhail G. Shatrov*¹, *Leonid N. Golubkov*², *Andrey U. Dunin*³, *Pavel V. Dushkin*⁴, *Andrey L. Yakovenko*⁵

UDC: 621.436.038

1. INTRODUCTION

Accumulator type fuel systems (Common Rail) are widespread due to their capability of in a timely manner depending on the mode of operation of the diesel engine to arrange the high pressure multiple injection with high precision.

As fuel systems are improved, the maximal injection pressure grows [8, 10]. In a number of publications, the issue of the need of injecting fuel under the pressure over 2500 bar is discussed [5, 6, 7, 9].

The pressure growth in case of multiple injection makes the fuel injection working process more complicated. Pressure oscillations at the injector inlet become more crucial which was noted by many researchers [1, 2, 3] including in MADI.

Applied research and experimental developments are carried out with financial support of the state represented by the Ministry of Education and Science of the Russian Federation under the Agreement No 14.580.21.0002 of 27.07.2015, the Unique Identifier PNIER: RFMEFI58015X0002.

2. EXPERIMENTAL SETUP

2.1 Measuring equipment

For carrying up experimental research of Common Rail diesel engine fuel systems, at the Department of Heat Engineering and Automobile and Tractor Engines of MADI, an experimental setup was developed on the base of a bench with low pressure fuel line and electric drive of a high pressure (HP) fuel pump. Common Rail fuel systems of various configurations may be mounted on the bench depending on the kind of the problem being handled.

For carrying out investigations, the station was complemented with measuring system having two piezoelectric sensors. The first sensor is mounted at the inlet of the common rail injector (CRI) and registers the pressure oscillations when fuel is injected. The second sensor is mounted in the chamber and registers the instants of fuel injection start and

¹ *Mikhail G. Shatrov, professor, University of MADI, Leningradsky Prosp.,64, Moscow, 125319, Russia, dvs@madi.ru*

² *Leonid N. Golubkov, professor, University of MADI, Leningradsky Prosp.,64, Moscow, 125319, Russia, dvsgolubkov@yandex.ru*

³ *Andrey U. Dunin, assist. prof., University of MADI, Leningradsky Prosp.,64, Moscow, 125319, Russia, a.u.dunin@yandex.ru*

⁴ *Pavel V. Dushkin, post-graduate student, University of MADI, Leningradsky Prosp.,64, Moscow, 125319, Russia, levvap@gmail.com*

⁵ *Andrey L. Yakovenko, assist. prof., University of MADI, Leningradsky Prosp.,64, Moscow, 125319, Russia, yakovenko_home@mail.ru*

end. The chamber presents an enclosed volume with a pressure discharge valve. The measuring system components are presented in Table 1.

Electronic control of fuel system is effected with the aid of microprocessor control system developed in MAD1. Measurement of injection rates was carried out using Collection of fuel for measuring injection rates is carried out with laboratory graduated jars.

Table 1 Measuring equipment

Name	Tool description
AVL A03 (Austria)	Dual-channel charge amplifier.
T6000 No 4636 (Russia)	Piezoelectric sensor. Sensibility: 2.1 pC/bar. Pressure measuring range 0...6000 bar.
T6000 No 4588 (Russia)	Piezoelectric sensor. Sensibility: 2.2 pC/bar. Pressure measuring range 0...6000 bar.
DMP304 (Germany)	Strain-gage sensor. Pressure measuring range 0...4000 bar.
Siglent AKIP 4126/2 (China)	Digital storage oscilloscope.

2.2 Configuration of fuel system and injection control

The fuel system includes: radial-plunger type HP fuel pump with throttle valve for fuel entering the pump, fuel accumulator with pressure sensor and two electro-hydraulic injectors. Parameters of its elements are presented in Table 2.

Table 2 Basic parameters of fuel system elements

Fuel system element	Parameters
CRI No1	No integrated fuel accumulator, pressure unbalanced valve, fuel injector nozzle hole diameter $d_c=0.12$ mm, number of holes 7.
CRI No2	Integrated fuel accumulator is present, pressure balanced valve, fuel injector nozzle hole diameter $d_c=0.09$ mm, number of holes 8.
Fuel line	Fuel line length $l_{\eta}=1000$ mm, channel diameter $d_{\eta}=2.2$ mm.

In both injectors, electromagnetic drive of the control valve is used. The second injector differs from the first one with the presence of a fuel accumulator integrated into the body and the design of the pressure balanced valve. Layouts of the injectors are presented in Figure 1.

The experiment was carried out in two stages: the first stage – the injector operate in case of a single injection; the second stage – the injector operate in case of multiple injection.

3. SINGLE INJECTION

At the first stage, the influence of the following factors on pressure oscillations at the CRI inlet was investigated (Figure 2): fuel pressure p_{ac} , control impulse duration τ_{imp} , type of fuel used. With this, two different injectors having principally different design were estimated in the experiment.

Fuel injection causes considerable oscillations of fuel pressure at the injector inlet. One of the reasons is hydraulic impact originating when closing the injector nozzle needle. In this way, in the injector No1 with pressure $p_{ac}=1000$ bar and control impulse duration $\tau_{imp}=0.6$ ms (corresponds to injection rate $Q=16.5$ mg), the injection causes pressure oscillations with amplitude up to 250 bar (Figure 3). Evidently, these oscillations influence the fuel supply process in case of multiple injections: the previous injections would influence on the following ones.

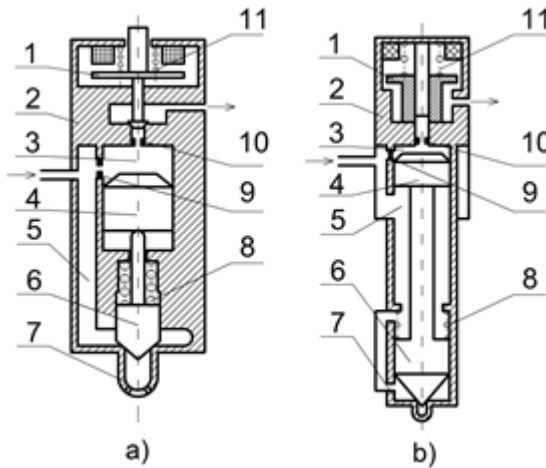

Figure 1 Layouts of the injectors:
a – injector No1, b – injector No2;

1 – control valve; 2 – CRI body; 3 – control chamber; 4 – multiplier (for version b, elements 4 and 6 are one piece); 5 (a) – channel supplying fuel to the injector nozzle; 5 (b) – fuel accumulator; 6 – injector nozzle needle; 7 – injector nozzle

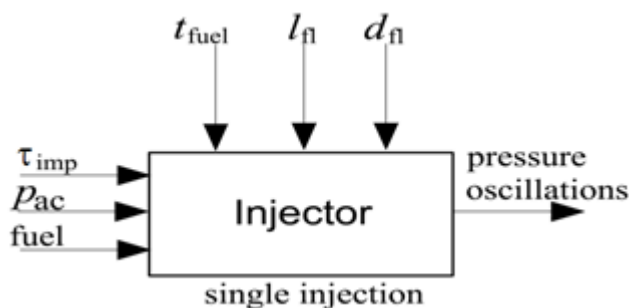

Figure 2 Layout of the first stage of the experiment:
controlled factors: τ_{imp} – control impulse duration, p_{ac} – pressure in the fuel accumulator,
 $fuel$ – working fluid (diesel fuel or sunflower oil); uncontrolled factors: t_{fuel} – fuel
temperature, l_{fl} – fuel line length, d_{fl} – fuel line diameter

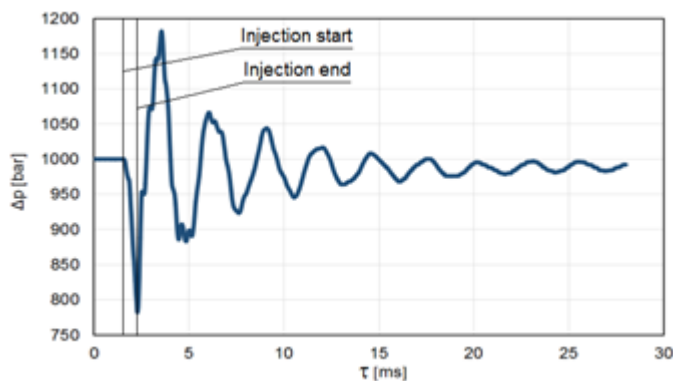

Figure 3 Pressure at the inlet of the CRI No 1 ($p_{ac}=1000$ bar, $\tau_{imp}=0.6$ ms)

As the fuel pressure and injection rate increase, the oscillation process increases. Figure 4 shows the comparison of data at three pressures in the fuel accumulator and constant control impulse duration $\tau_{imp}=0.6$ ms. A single injection is used. The pressure oscillation range at the CRI inlet at $p_{ac}=1500$ bar is up to 350 bar, and at $p_{ac}=500$ bar, the amplitude decreases to 80 bar.

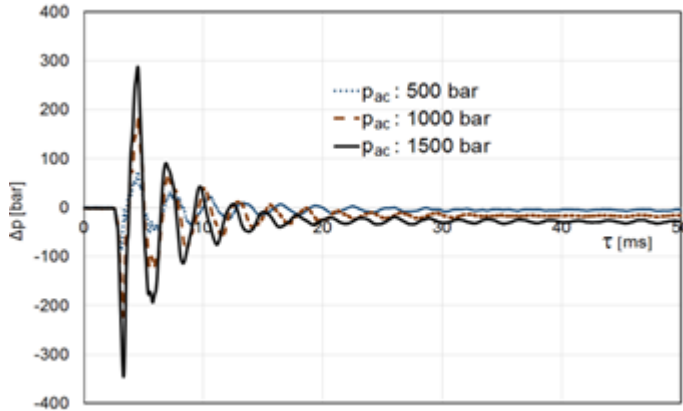

Figure 4 Fuel pressure oscillations at the entry of the CRI No1 at various pressures ($\tau_{imp}=0.6$ ms)

Figure 5 shows the comparison at constant pressure in the fuel accumulator $p_{ac}=1000$ bar and variation of the first control impulse duration. On the basis of this, one can make a conclusion that as the first portion of fuel decreases, the oscillations range also decreases.

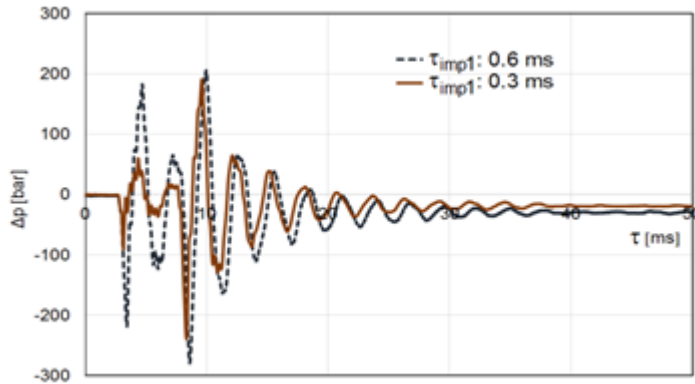

Figure 5 Fuel pressure oscillations at the entry of the CRI No1 at various duration of the first injection ($p_{ac}=1000$ bar)

Figure 6 shows the data for the injector No2 at the operation mode $p_{ac}=1000$ bar and $\tau_{imp}=0.6$ ms. Compared with the No1 version of the CRI (Figure 3), the pressure oscillations are considerably lower. The pressure oscillations range for the version No1 is 400 bar, and for the version No2 – 120 bar, that is, 3.3 times lower. Hence, the internal volume of the injector plays a considerable role and may be an efficient measure for lowering pressure oscillations.

The injector No2, has a pressure balanced valve in addition to integrated fuel accumulator. The balanced valve makes it possible not only to decrease the volume of fuel leaks at high pressure, but also to improve the injector working process in case of multiple injection [4].

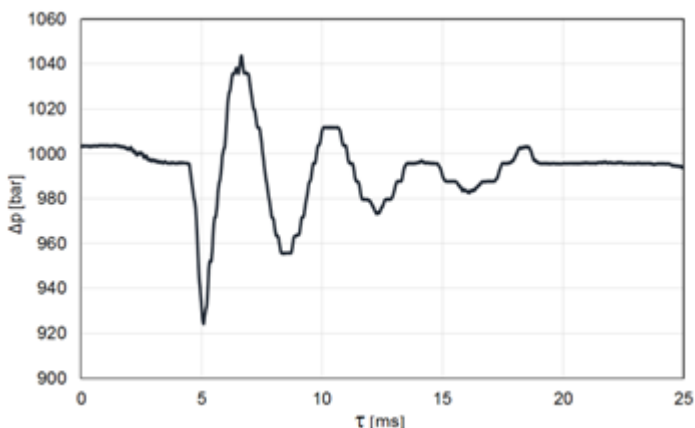

Figure 6 Pressure at the inlet of the CRI No2 ($p_{ac}=1000$ bar, $\tau_{imp}=0.6$ ms)

Physical properties of fuel used are also important in case of fuel injection. As the viscosity of fuel increases, the hydraulic friction grows which contributes to rapid damping of oscillations. Figure 7 shows the data for the injector No1 when operating on sunflower oil. As compared with diesel fuel (Figure 3), the oscillations range decreases from 400 bar to 250 bar at the same operating mode.

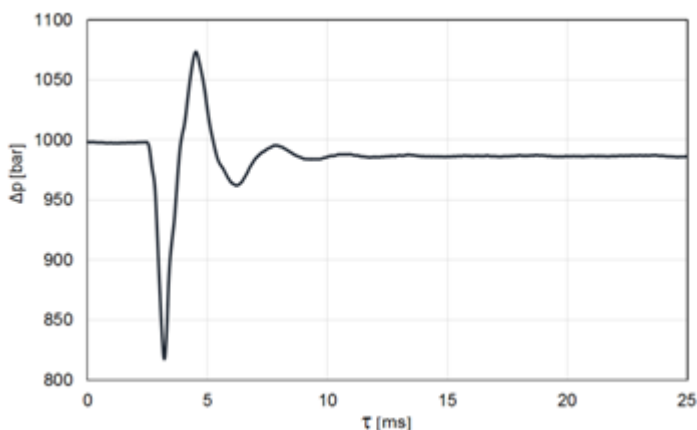

Figure 7 Pressure at the inlet of the CRI No1 ($p_{ac}=1000$ bar, $\tau_{imp}=0.6$ ms), operation on sunflower oil

4. HYDRODYNAMIC EFFECTS IN CASE OF MULTIPLE INJECTION

At the second stage, the influence of the interval between the impulses of a double injection on the injection rate value of the second portion was investigated. In this experiment, the injector No1 was used. The layout of the second stage of the experiment in case of a double injection is presented in Figure 8.

The oscillogram of a current passing through electric magnet of injector No1 is shown in Figure 9. The injector control is carried out in two phases: forcing and holding. For forcing, voltage of about 50 V is applied to the electric magnet during 0.3 ms which promotes a rapid raise of the control valve. The injector needle is held using pulse-width modulation with duty ratio 50%.

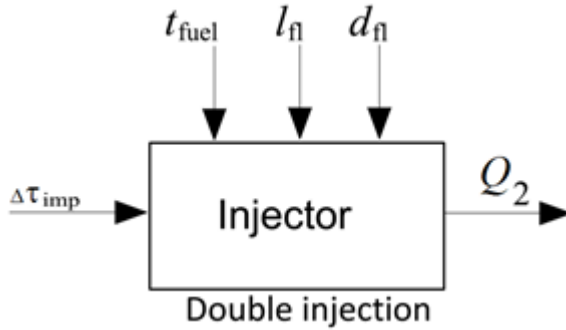

Figure 8 Layout of the second stage of the experiment:
 controlled factor: $\Delta\tau_{imp}$ – interval between two portions of a double injection; uncontrolled factors: t_{fuel} – fuel temperature, l_{fl} – fuel line length, d_{fl} – fuel line diameter; output parameter: Q_2 – injection rate of the second portion of a double injection

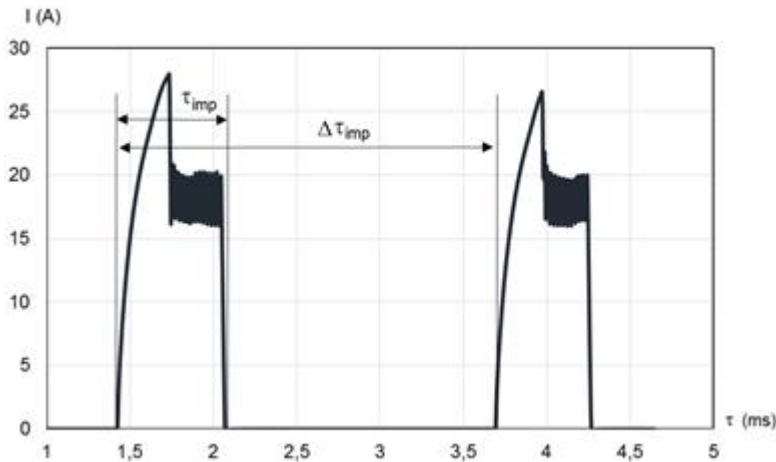

Figure 9 Oscillogram of current passing through electric magnet of injector No1 (double injection): τ_{imp} – control impulse duration, $\Delta\tau_{imp}$ – interval between two portions of double injection

Injector rate and injection characteristic of the second portion depend on the time at which the second injection is effected related to the first one. Figure 10 shows the results of the investigations at constant pressure $p_{ac}=1000$ bar, two injections each having $\tau_{imp}=0.6$ ms with variable interval $\Delta\tau_{imp}$. The vertical line designates the instant of fuel portion injection start.

The superposition of waves in case of multiple injection may result both in amplification and damping of oscillations process. If the second injection is executed at the rear wave edge (pressure increase) or in the zone of minimum – the oscillations damping takes place. If the second injection is executed at the front (decreasing) wave edge or in the zone of maximum, the oscillations increase.

Figure 10 shows that at the interval $\Delta\tau_{imp}=3.6$ ms, after injection of the second portion, the maximal pressure oscillations range is 330 bar. At the interval $\Delta\tau_{imp}=5.5$ ms, the maximal range increases 1.45 times to 480 bar.

Figure 11 shows the results of estimation of the dependence of the injector rate Q of the second injection on the interval between injections. The first injection value is constant and amounts to $Q_1=16.5$ mg. The difference between the first and the second magnitudes of the injection rate is almost 2 times.

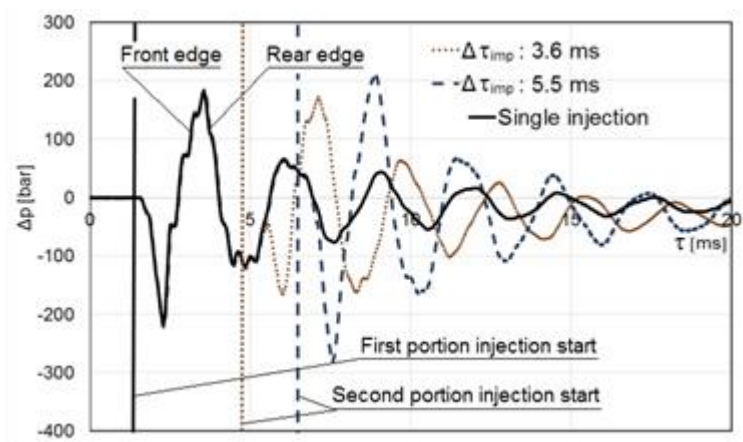

Figure 10 Pressure oscillations at the inlet of CRI No1 at various intervals between double injection
 $\Delta\tau_{imp}$ ($p_{ac}=1000$ bar)

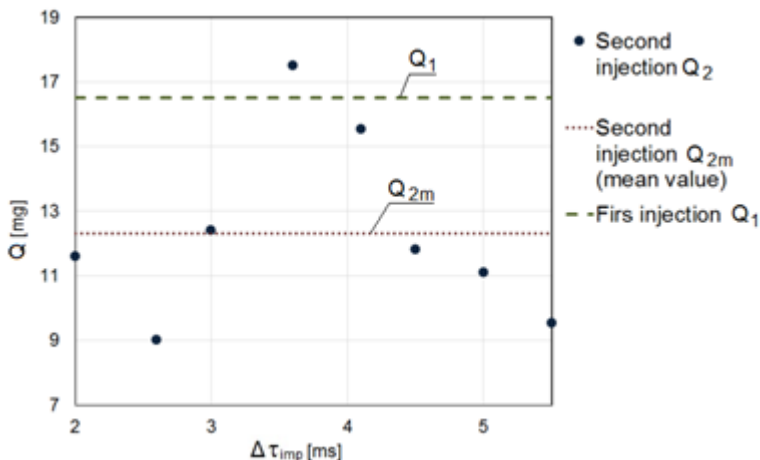

Figure 11 Fuel injection rate at various intervals between injections $\Delta\tau_{imp}$ ($p_{ac}=1000$ bar, $\tau_{imp}=0.6$ ms)

It should be mentioned that the average value of the second injector rate is considerably lower than of the first one.

Even if the beginning of the second injection is shifted removed from the first injection to the interval $\Delta\tau_{imp} = 50$ ms, the value of the second portion is 13.1 mg which is by 3.4 mg lower than the first one though the pressure oscillations of the first injection are damped completely during 50 ms.

This phenomenon has two explanations.

First, the pressure in the fuel accumulator drops after the first injection. The pressure deviation value is not large and according to data presented in Figures 3...4, amounts to 50 bar (depending on operation mode).

The second factor is voltage slump on the injectors power supply condenser. It follows from Figure 9 that forcing current of the second injection is by 2.5 A lower than the first one which promotes the longer opening of the injector.

In this way, modern injection system also makes stringent requirements to such parameters as fuel pressure control dynamics and charging the power supply condenser of the injectors.

Injection characteristic of the second fuel portion also depend on $\Delta\tau_{imp}$ because the pressure in the needle volume is interlinked with the pressure at the inlet of the CRI. For example, if the injection of the second fuel portion starts in the zone of pressure wave minimum and terminates in the zone of maximum (Figure 10), the fuel flow velocity through the spray holes will vary during the injection process from low to high.

Simulation was carried out to estimate the influence of fuel type and time interval $\Delta\tau$ (Figure 12) between control impulses of double injection on the value of the injection quantity of the second portion at pressures 2000...3000 bar.

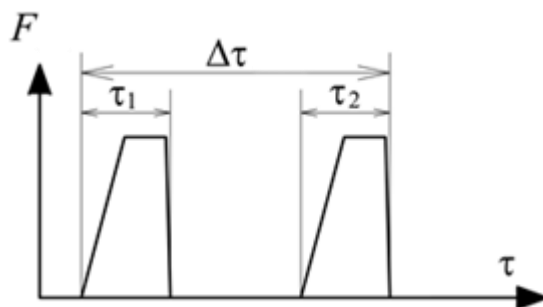

Figure 12 Control impulses modelled: F – injector electromagnet force, $\Delta\tau$ – time interval between control impulses, τ_1 – first control impulse duration, τ_2 – second control impulse duration

The simulation was carried out using the software package which is being developed in MADI.

The CRI No2 was selected as a subject of research, because it is providing a smaller pressure oscillations range.

The flow chart of the simulation is shown in Figure 13. Two equal control impulses were modeled ($\tau_1 = \tau_2$). Duration of the control impulses τ was selected such that the fuel quantity supplied during the first injection was $Q_1 \approx 3 \dots 4$ mg.

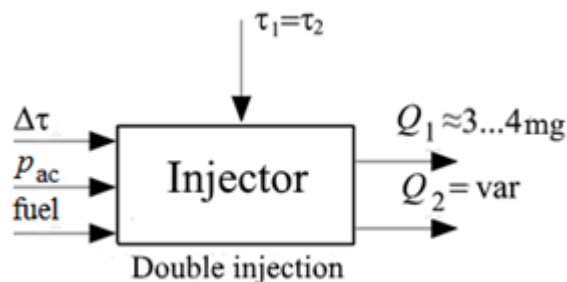

Figure 13 Test flow chart: Q_1 , Q_2 – injection rate values of the corresponding portions

Computation results of operation of the CRI No2 on diesel fuel are presented in Figure 14.

As was demonstrated during experimental tests (Figure 11), the reason of variation of injection rates versus $\Delta\tau$ were pressure oscillations at the inlet to the injector.

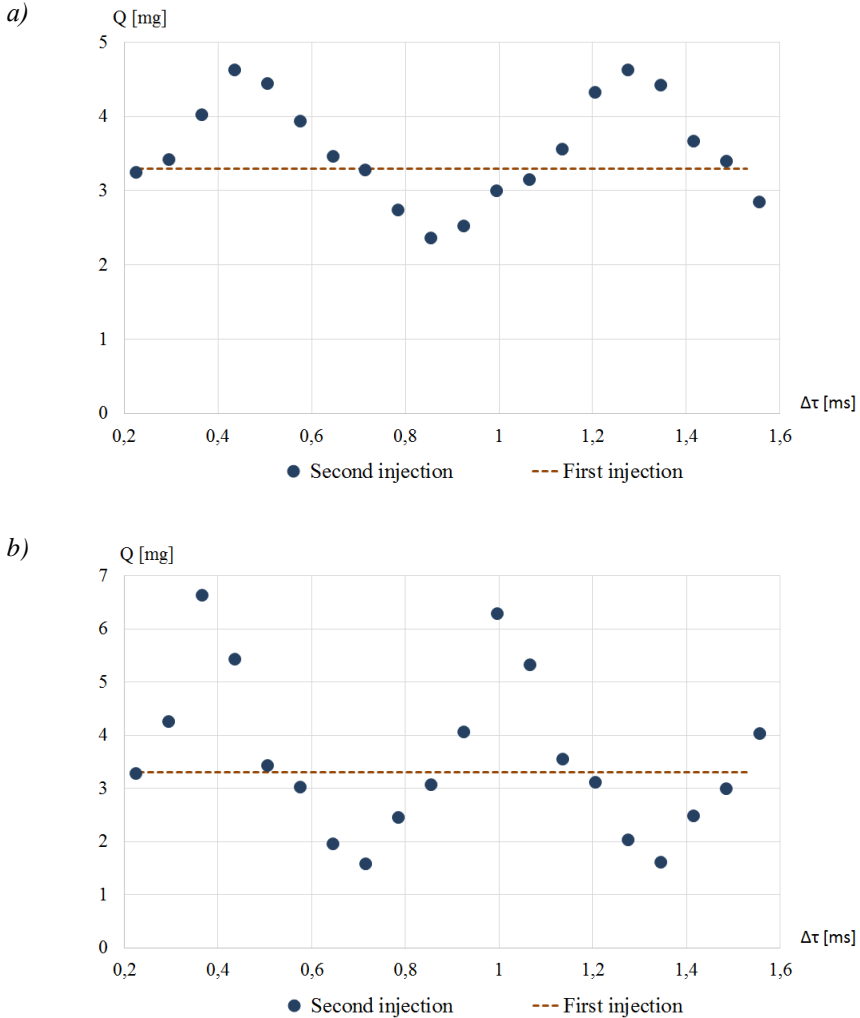

Figure 14 Injection rate Q_2 at different intervals between injections $\Delta\tau$ for diesel fuel ($Q_1 = 3.3$ mg):
 $a - p_{ac} = 2000$ bar, $b - p_{ac} = 3000$ bar

When the pressure p_{ac} grows, the oscillation phenomenon and its impact on the working process increase. When operating on diesel fuel at pressure $p_{ac} = 2000$ bar, the spread in injection rates of the second portion is $Q_2 = 2.36 \dots 4.62$ mg, and at $p_{ac} = 3000$ bar $Q_2 = 1.58 \dots 6.63$ mg.

The results of imitation carried out for a more dense fuel corresponding to sunflower oil are presented in Figure 15.

The main difference of Figure 14 from Figure 15 is a faster attenuation of oscillations observed when passing to a more dense fuel. In case of $p_{ac} = 2000$ bar, the spread in injection rates of the second portion is $Q_2 = 2.96 \dots 4.21$ mg, and at $p_{ac} = 3000$ bar – $Q_2 = 2.42 \dots 5.50$ mg.

It is seen from comparison of calculated data (Figure 14 and Figure 15) that due to a higher hydraulic friction, the maximal pressure oscillations range is lower. This will have a positive effect on the control precision of the second portion of fuel injected.

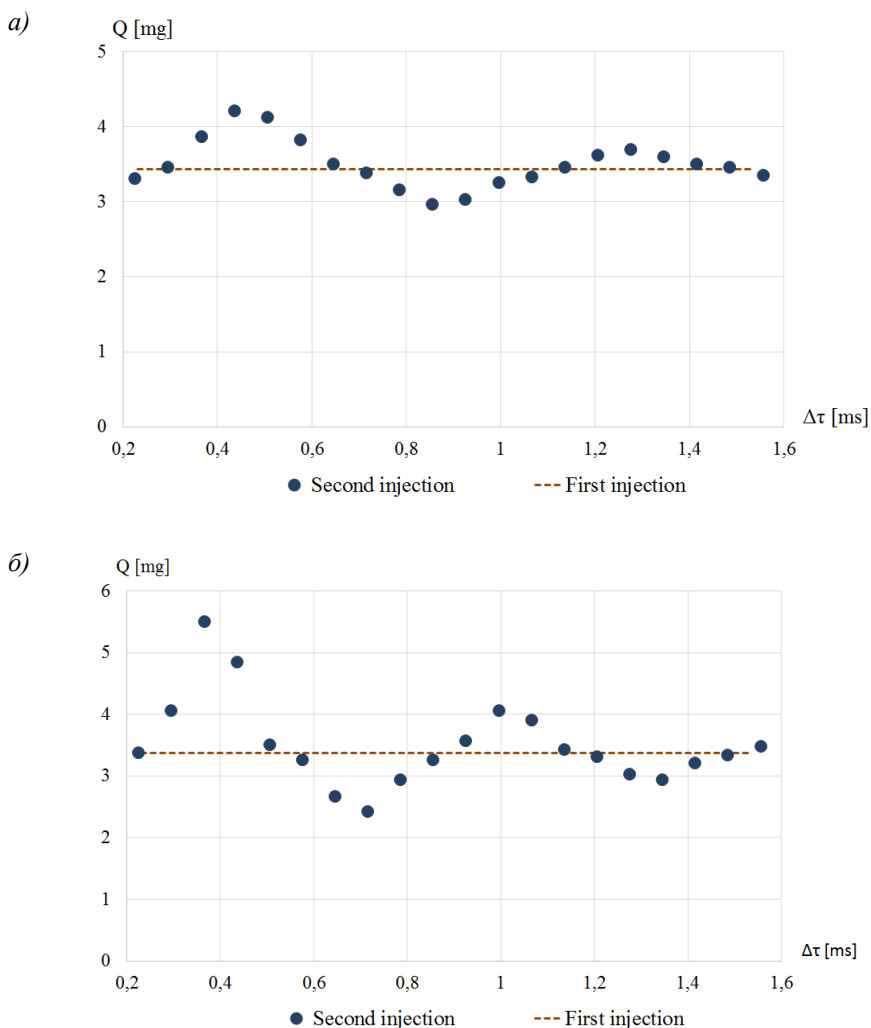

Figure 15 Injection rate Q_2 at different intervals between injections $\Delta\tau$ for a more dense fuel ($Q_1 = 3.4$ mg):
 $a - p_{ac} = 2000$ bar, $b - p_{ac} = 3000$ bar

5. CONCLUSIONS

1. Fuel injection causes considerable pressure oscillations at the inlet of the injector. The oscillations range depends on: injection pressure, control impulse duration, fuel physical properties and injector design. One of the reasons of oscillations is hydraulic impact which takes place when the injector needle closes.

2. The pressure drop in the accumulator after preliminary injection (the amount of deviation of the pressure is 5 MPa depending on the mode) and the voltage drop across the capacitor of the power injector (the current boost of the second injection of 2.5 A less than the first) favors longer opening of injectors in case of next injection.
3. The presence of fuel accumulator integrated into the CR injector body decreases wave phenomenon related to fuel injection. During experiments with the injector CRI No2 having an integrated fuel accumulator ($p_{ac}=1000$ bar, $\tau_{imp}=0.6$ ms), the impulse amplitude at the inlet to the injector was 120 bar which is 3.3 times lower than in the injector CRI No1 having no fuel accumulator.
4. When the fuel accumulator pressure p_{ac} grows, the oscillation phenomenon and its impact on the working process increase. So when operating on diesel fuel at pressure $p_{ac}=2000$ bar, the spread in injection rates of the second portion is $Q_2 = 2.36 \dots 4.62$ mg, and at $p_{ac}=3000$ bar $Q_2 = 1.58 \dots 6.63$ mg.
5. When switching to a fuel with a higher viscosity due to the increase of the hydraulic friction there is a more rapid attenuation of the pressure oscillations caused by the preliminary injection. So when injector CRI No1 operates ($p_{ac}=1000$ bar, $\tau_{imp}=0.6$ ms) on sunflower oil the pressure oscillations range decreases from 40 MPa (operation on diesel fuel) to 25 MPa (operation on sunflower oil).

ACKNOWLEDGMENTS

Applied research and experimental developments are carried out with financial support of the state represented by the Ministry of Education and Science of the Russian Federation under the Agreement No 14.580.21.0002 of 27.07.2015, the Unique Identifier PNIER: RFMEFI58015X0002.

REFERENCES

- [1] Beirer, P. Experimental and numerical analysis of hydraulic circuit of a high pressure Common Rail diesel fuel injection system. Tampere: Tampere University of Technology, Finland, 2007, 198 p
- [2] Catania, A. E., Ferrari, A., Manno, M. Parametric Study of Hydraulic Layout Effects on Common-Rail Multiple Injections. 2005 Fall Technical Conference of the ASME ICED, Paper No. ICEF 2005-1288, Ottawa, Canada, 2005
- [3] Catania, A. E., Ferrari, A., Manno, M., Spessa, E. Experimental investigation of dynamics effects on multiple-injection Common Rail system performance. Journal of Engineering for Gas Turbines and Power, ASME. Volume 130. pp. 032806-032813
- [4] Leonhard, R., Warga, J., Pauer, T., Ruckle, M., Schnell, M. Solenoid Common Rail injector for 1800 bar. MTZ worldwide, February 2010, pp. 10-15
- [5] Pflaum, S., Wloka, J., Wachtmeister, G. : Emission reduction potential of 3000 bar Common Rail Injection and development trends. CIMAC Paper No. 195, CIMAC Congress Bergen, 2010
- [6] Shatrov, M. G., Golubkov, L. N., Dunin, A. U., Yakovenko, A. L., Dushkin, P. V. : Research of the injection pressure 2000 bar and more on diesel engine parameters. International Journal of Applied Research ISSN 0973-4562 Volume 10, Number 20 (2015) pp. 41098-41102

- [7] Sunwoo, K., Namhoon, C., Namhoon, C. Injection Rate Estimation of a Piezo-Actuated Injector. SAE Paper 2005-01-0911, USA, 2005
- [8] Why higher injection pressure saves fuel and also increases performance and torque, Bosch Media Service, 2013
- [9] Wloka, J. ; Pötsch, C. ; Wachtmeister, G. : Injection spray visualization for 3000 bar Diesel injection. 24th Conference of the Institute for Liquid Atomization and Spray Systems, 2011
- [10] Working best under pressure, Transport Engineer, November 2010, pp. 20-22.