



Comparison of DBA vs. DBF by Explanation of Design Characteristics of Hyperbaric Oxygen Chamber

Tahir ALTINBALIK^{a*}, Tolga KABAK^b

^aTrakya University, Engineering Faculty, Mechanical Engineering Department, Edirne / TURKEY

^bBaroks Hyperbaric Technology, İstanbul / TURKEY

Abstract Pressure vessel cylinders find wide applications in many areas such as thermal and nuclear power plants, process and chemical industries, and hyperbaric oxygen therapy chamber. A hyperbaric chamber is a specific pressure vessel. A hyperbaric oxygen chamber is designed to meet a number of criteria regarding safety and ease of use. In human medicine, HBOT (Hyperbaric Oxygen Therapy) is most widely known for the treatment of decompression sickness for divers and more recently for a variety of medical conditions. The objective of this research work is to compare the design of the HBO cabin for divers, using two approaches called 'design by analysis' (DBA) and 'design by formula' (DBF). For this purpose determination of sheet thickness of 5 main and important parts of a chamber was performed. These are, main body, torispherical head, doors, medical lock outside wall and porthole flange. Firstly, the required material thicknesses were calculated by the empirical formulas according to AD 2000 Merkblatt pressured vessels standard and then results were examined by the SolidWorks analysis module. AD2000 MB formulas include high safety factors. Then, the SolidWorks analysis was repeated with the safety factor of 3 and the new sheet thickness values for the chosen parts were determined. Finally, cost analysis was done. It is shown that the thicknesses suggested by authors are more reliable than those presented numerically. For material thicknesses suggested by authors, weight and the total cost of the HBO chamber has been reduced by %55.

Keywords Algorithm, differential equations, nonlinear, two-step

1. Introduction

Engineering design is the process by which engineers' intellect, creativity, and knowledge are translated into useful engineering products that satisfy particular functional requirements and meet engineering specifications while complying with all constraints. The traditional design approach has been one of deterministic problem solving, typically involving efforts to meet functional requirements subject to various technical specifications and economic constraints, among others [1].

Imagining power plants, chemical processing units and many other manufacturing facilities without pressure vessels is difficult. Pressure vessel cylinders find wide applications in thermal and nuclear power plants, hot water storage tanks, process and chemical industries, hyperbaric oxygen therapy chamber for humans and pets, in space and ocean depths, and fluid supply systems in industries [2]. Industrial pressure vessels are usually structures with complex geometry containing numerous geometrical discontinuities and are often required to perform under complex loading conditions such as internal pressure, external forces, thermal loads, etc. [3]. Pressure vessels can theoretically be almost any shape, but shapes made of sections of spheres, cylinders, and cones are usually employed. Pressure vessel design has been historically based on Design by Formula. Standard vessel configurations are designed using a series of simple formulae and charts. Many pressure vessel in the process industry in the world is designed according to ASME Section VIII, Division 1 or AD2000 Merkblatt



standards, better known as the “design by rule” or “design by formula” approach. Unfortunately, this approach has its own problems because the empirical relations developed are primarily based on experience, simple mechanics and assume large factors of safety. It should be noted that large safety factors lead to increasing the material thickness, while safety is not necessarily increased; recall that fracture toughness decreases with increasing thickness, and stress corrosion cracking at components operating in corrosive environments is expected to be higher in thicker parts [4]. After 2000, finite element analysis (FEA) was included as a standard practice in most of pressure vessels design codes. Nowadays in addition to the Design by Formula route, many national codes and standards for pressure vessel and boiler design, also provide for a Design by Analysis route. Using the design by analysis, the designer is able to calculate stresses everywhere in the vessel. DBA procedures do not specify particular implementation tools. However, the most widely used technique in contemporary pressure vessel design is the finite element method (FEM), a powerful technique allowing the detailed modelling of complex vessels [5].

The design of pressure vessels for operation at high pressures is a complex problem, so finite element methods are the most frequently used because finite element analysis offers a great deal of promise over other approaches mainly experimental, in the sense of low cost, high speed, complete information, and ability to simulate realistic and ideal conditions [6]. Finite element analysis (FEA) utilizing the commercial software packages will be more appropriate for shell structures involving elements of arbitrary thickness and curvature to obtain the stress distribution around discontinuities [7]. Finite element method (FEM) is currently one of the most common numerical methods used for simulations in mechanical engineering. Modern software systems usually allow using FEM, which enables solving mathematically difficult and time-consuming operations in a meantime. The basic idea of the FEM is simple, as it requires splitting the solution area to a finite number of sub areas - elements. These elements are called finite elements. Density of the network fundamentally affects the quality of the results and amount of used computer memory Finite element analysis (FEA) utilizing the commercial software packages (ANSYS, SolidWorks, MARC, etc.) will be more appropriate for shell structures involving elements of arbitrary thickness and curvature to obtain the stress distribution around discontinuities [8].

Yeom [9] investigated the behaviour of pressure vessels with ellipsoidal and torispherical heads under internal pressure loading. The head thickness was assumed to be equal to the thickness of the cylinder and the investigation was carried out by finite element analysis and lower bound limit analysis. Wilczynski [10] numerically determined by means of FEM an optimal shape of thin elastic shells of revolution loaded by internal pressure. Kedziora and Kubiak [11], using FEM, numerically calculated the stress distribution in pressure tanks. Widera and Wei [12] presented a finite element model for the analysis of thin shell intersections with large diameter ratio. Petrovic [13] investigated and determined the influence of forces that can act on a nozzle, in a cylindrical pressure vessel. In the mentioned study, the FEM applied to determine the state of stress in the cylindrical shell. Diamantoudis and Kermanidis [14] compared the design of pressure vessels of high strength steel P500 with the steel alloy P355 using the rules of DBA and DBF. Gross plastic deformation loads were evaluated for two sample torispherical heads by 2D and 3D FEA based on an elastic-perfectly plastic material model by Mackenzie *et al* [15]. Gong *et al.* [16] performed a finite element analysis of open top tanks and explained that the structure parameters of top stiffening rings play a significant role on the failure of the tank. Finite element analysis (FEA) has been carried out using ANSYS software package with 2D axisymmetric model to access the failure pressure of cylindrical pressure vessel made of ASTM A36 carbon steel having weld-induced residual stresses by Jeyakumar and Christopher [17]. Three 2-D axisymmetric finite element models with different vessel radii were constructed and analysed by Lu *et al.* [18]. Al-Gahtani *et al.* [19] presented the findings of a finite element study of the effect of cap size on the stresses near the junction of a cylindrical nozzle with a spherical vessel under internal pressure. Murtaza [20] aimed to compare the design of the RPV, using two approaches called ‘design by analysis’ (DBA) and ‘design by formula’ (DBF). Altınbalık and Kabak [21] discussed the use of stainless steel instead of pressure vessel steel P275 GH by means of cost and weight analysis. In the mentioned study the required sheet thickness calculated by the empirical formulas according to AD 2000 pressured vessels standard and then results examined by the SolidWorks analysis module. In another study, Altınbalık and Kabak [22] performed the design of penetrator parts and determination of sheet



thickness for a hyperbaric diver chamber by means of the AD 2000 pressured vessels standard and SolidWorks. SolidWorks simulation is a software that allows the use of finite element analysis FEA.

A pressure vessel can be designed using the rules of 'design by formula' and 'design by analysis'. The objective of this research work is to compare the design of a HBO chamber for divers using the two approaches called DBA and DBF. First, the sheet thicknesses for selected parts of a hyperbaric chamber were calculated by the empirical formulas according to AD 2000 pressured vessels standard and then results were examined by the SolidWorks analysis module. The SolidWorks analysis was performed again the whole selected parts with the safety factor of 3 and the new sheet thickness values for the mentioned parts were determined. Finally, cost analysis was done.

2. Pressure Chamber for Divers

Hyperbaric oxygen therapy (HBOT) is defined as delivery of 100% oxygen at pressures about one-and-a-half to three times that of the normal atmosphere while the patient is placed and being pressurised in a chamber. HBOT is increasingly being recognised as an important adjunct in a select group of indications for which there is mounting scientific evidence [23]. Hyperbaric oxygen chambers for divers are used on land and above the water to take surface supplied divers who have been brought up from underwater through their remaining decompression as surface decompression either after an ambient pressure ascent or after transfer under pressure from a dry bell. In this study, a six person multiplace hyperbaric cabin was chosen to carry out analysis as shown in Fig.1. The cabin operation pressure is 5.94 Bar. Designed parts are also shown clearly in the figures. Several materials have been used for the penetrators. The flow stresses of the materials and the other specifications for selected parts of the cabin were given in detailed as seen below.

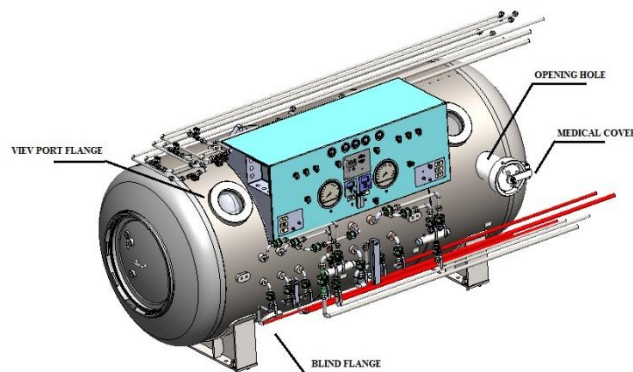

Figure 1: Schematic view of multiplace hyperbaric chamber

3. Theoretical Calculations

3.1. Determination of Sheet Thickness of Main Body

The most important structural element of a hyperbaric chamber is main cylindrical body. Geometrical dimensions and technical data of such a multiplace cabin are given in Fig.2:

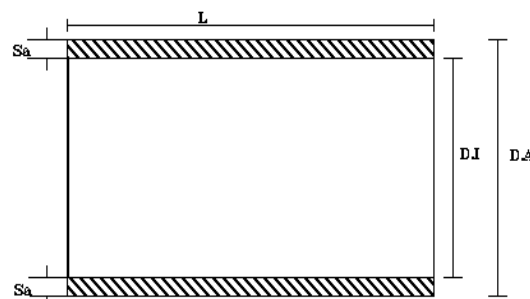

Figure 2: Geometrical dimensions of main body



Necessary Nomenclature

$P = 5.94$ bar (Maximum Allowable Pressure)

$D_a = 1524$ mm (Outer diameter of the main body)

$D_i = 1504$ mm (Inner diameter of the main body)

$K = 330$ N/mm² (P355GH EN 10028-2)

$V = 0.8$ (welding factor)

$s = 1.7$ (safety factor)

$C_1 = 0.5$ mm (Tolerance factor)

$C_2 = 3$ mm (Corrosion factor)

Although there are different formulas for determining the sheet thickness of main body in order to AD 2000 MERKBLATT standard the thickness is determined as below:

$$S_t = \frac{D_a \times P}{20 \times \frac{K}{s} \times V + P} + C_1 + C_2 \quad (1)$$

$$S_t = \frac{1524 \times 5.94}{20 \times \frac{330}{1.7} \times 0.8 + 5.94} + 0.5 + 3 = \frac{9052.56}{3106 + 5.94} + 0.5 + 3 = 6.4 \text{ mm}$$

Although the formula gives us this thickness value, the thickness of the head must also be determined in order to determine the main body thickness. Thus, it is intended that the main body and the head are compatible. The head thickness is chosen as 10 mm as seen in the calculations below. Then, 10 mm. sheet thickness is also chosen for main body.

3.2. Thickness Calculation of Outside Torispherical Head

These heads have a dish with a fixed radius (r_1), the size of which depends on the type of torispherical head. The transition between the cylinder and the dish is called the knuckle. The knuckle has a toroidal shape. In this study torispherical head was designed according to Klöpper type head geometrical dimensions as shown in Fig.3 ($R = D_a$, $r = 0.1D_a$ and $h_2 = 0.1935D_a - 0.455S_e$).

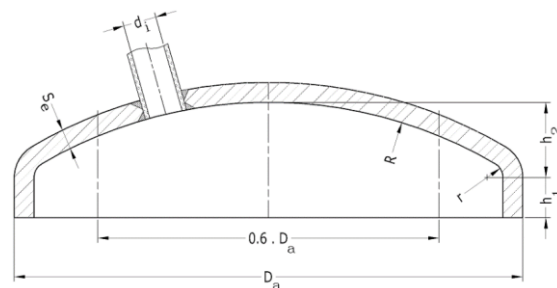

Figure 3: Geometrical dimensions of torispherical head

Necessary Nomenclature

S : (Calculated torispherical head thickness)

S_e : (Instant torispherical head thickness)

$K = 330$ N/mm² (P355GH EN 10028-2)

β : (Design factor)

$$\frac{S_e - C_1 - C_2}{D_a} \quad (2)$$

As explained detailed in the previous work of authors [24] a predictor-corrector cycle is performed for the determination of the sheet thickness of the outside torispherical head. First operation of calculation is to predict S_e value and insert it into the equation 2, and the β corresponding to the S_e value in the graph which given in ref [24] is read. After that, the S value is calculated by inserting β into the equation 3. Assuming the calculated S



value as S_e , it is again inserted into the equation 2 and a predictor-corrector cycle is performed. This iteration is continued until the difference between the allowable value and final value becomes less than 0.1.

First Iteration: $S_e = 10mm$ is selected

$$\frac{S_e - C_1 - C_2}{D_a} = \frac{10 - 0.5 - 3}{1524} = 0.0043 \rightarrow \beta = 3.4$$

$$S = \frac{DxPx\beta}{\left(\frac{40xKxV}{s}\right)} + C_1 + C_2 \tag{3}$$

$$S = \frac{1524 \times 5.94 \times 3.4}{40 \times \frac{330}{1.7} \times 0.8} + 0.5 + 3 = 8.95mm$$

After the 2nd iteration $S=8.82$ mm is obtained and this value inserted in Eq.2 as S_e . Then $S=8.89$ mm. is obtained and 10 mm. sheet thickness is chosen as standard product.

3.3 Calculation of Door Thickness and Radius

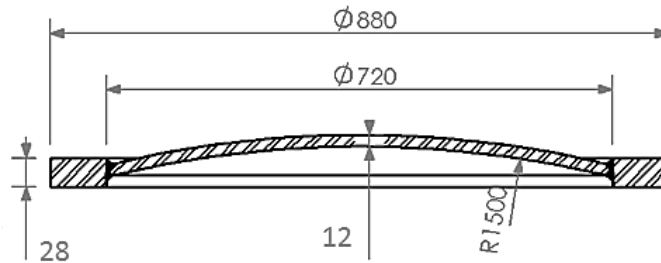

Figure 4: Geometrical dimensions of door and radius

Necessary Nomenclature for the door

- $D_i = 880$ mm (Design diameter)
- $K = 265$ N/mm² (P265 GH)
- $C = 0.45$ (Design factor for door)

$$S = C \times D_i \times \sqrt{\frac{P \times S}{10 \times K}} + C_1 + C_2 \tag{4}$$

$$S = 0.45 \times 880 \times \sqrt{\frac{5.94 \times 1.7}{10 \times 265}} + 0.5 + 3 = 27.94mm$$

In accordance with the empirical calculation thickness of the door has been chosen as 28 mm.

For the radius

- $D_i = 720$ mm (Design diameter)
- $R = 1500$ mm (Door head radius)
- $K = 330$ N/mm² (P355GH EN 10028-2)
- $C_N = 1.2$ (welding factor of flange section)
- S : (Calculated radius thickness)
- S_e : (Instant radius thickness)

$$\frac{S_e - C_1 - C_2}{R} = \sqrt{d_i(S - C_1 - C_2)} \tag{5}$$

$$S = \frac{P \times R \times C_N \times \beta}{20 \times \frac{K}{s}} + C_1 + C_2 \tag{6}$$



Similar to outside torispherical head calculation first operation of calculation is to predict S_e value and insert it into the equation 5, and the β corresponding to the S_e value in the graph is read. The next calculation steps are same as the described above for torispherical head.

First Iteration: $S_e = 10mm$ is selected

$$\bar{X} = \frac{10 - 0.5 - 3}{1500} \sqrt{720(10 - 0.5 - 3)} = 0.296 \rightarrow \beta = 2.65$$

$$S = \frac{P \times R \times C_N \times \beta}{20 \times \frac{K}{s}} + C_1 + C_2 = \frac{5.94 \times 1500 \times 1.2 \times 2.65}{20 \times \frac{330}{1.7}} + 0.5 + 3 = 10.8mm$$

After the 2nd iteration the difference between the allowable value and final value becomes less than 0.1 and is obtained as $S=10.72$ mm. The radius is chosen as 12 mm.

3.4. Thickness Calculation of Medical Lock Outside Wall

The section of the medical wall left outside the chamber ensures to put any medical devices, needles, garments, patient-masks or foods inside the chamber as seen in Fig.5.

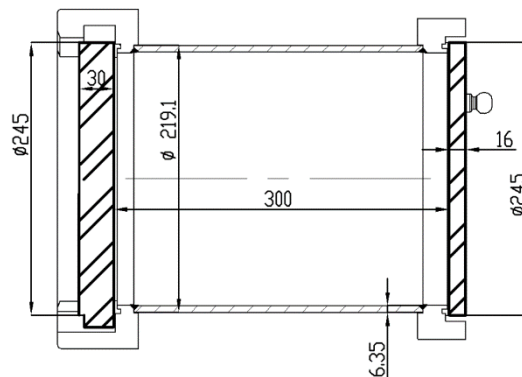

Figure 5: Geometrical dimensions of medical lock outside wall

Necessary Nomenclature

- $D_1 = 245mm$ (cover diameter)
- $K = 205 N/mm^2$ (AISI 316)
- $C_2 = 0$ mm (corrosion factor)
- $C = 1.25$ mm (design factor for outside wall medical lock)

$$S = C \times D_1 \times \sqrt{\frac{P \times S}{10 \times K}} + C_1 + C_2 \tag{7}$$

$$S = 1.25 \times 245 \times \sqrt{\frac{5.94 \times 1.7}{10 \times 205}} + 0.5 + 0 = 21.99mm$$

In accordance with the empirical calculation thickness of the outer wall of the medical lock has been chosen as 22 mm.

3.5. Thickness Calculation of Porthole Flange

There are windows ensuring peeping inside of the chamber from outside. Porthole flange fixes the porthole acrylic, made of acrylic, on the wall of the chamber. Schematic representation of the porthole flange and related dimensions are given in Fig.6.



Figure 6: Geometrical dimensions of porthole flange

Necessary Nomenclature

$K = 265 \text{ N/mm}^2$ (P265 GH)

$d_i = 277 \text{ mm}$ (Internal diameter of porthole)

$d_o = 375 \text{ mm}$ (External diameter of porthole)

$b = 20 \text{ mm}$ (selected nozzle thickness)

L_s : (Nozzle length-outward)

m : (Nozzle length-inward)

S_m : Main body sheet thickness

For the porthole flange, firstly max. nozzle length that protrudes outward from cylindrical shell is calculated as;

$$L_s = 1.25\sqrt{(d_i + b - C_1 - C_2) \times (b - C_1 - C_2)} \tag{8}$$

$$L_s = 1.25\sqrt{(277 + 20 - 0.5 - 3) \times (20 - 0.5 - 3)} = 151.4 \text{ mm}$$

Thus, it is understood that the length of the inner nozzle could not be longer than 151.4 mm.

m value is given in AD2000 MB standard for porthole flange as;

$$m \leq L_s/5 = 151.4/5 = 30.2 \text{ mm} \tag{9}$$

So, m value is chosen as 30 mm

Porthole flange may be machined from sheet at any thickness to be desired. Mentioned thickness has been chosen by us as 80 mm. Thus, after machining the surfaces, the total flange thickness becomes 79 mm as shown in the Figure 6. Since the body sheet thickness is 12 mm, it shall be proper and convenient that L_s value is to be chosen as 37 mm. So, the total flange length;

$$L = m + L_s + S_m \tag{10}$$

$$L = 30 + 37 + 12 = 79 \text{ mm}$$

4. Comparison of the Results by SolidWorks

AD2000 MB standard formulations have been making calculations in accordance with the large factors of safety. From this point of view thicknesses of components which have been found by means of calculations shall operate and work safely under the current internal stress conditions. However, yet, it is advised and recommended that empirical calculations are to be checked and verified by using SolidWorks.

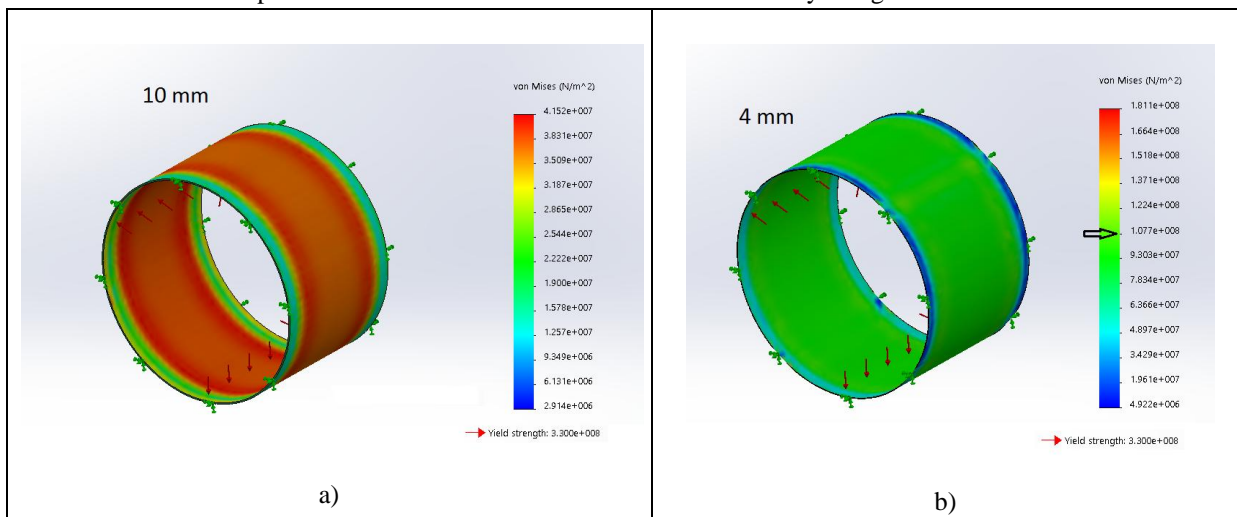

Figure 7: Stress analysis results of main body
 a) $s = 10 \text{ mm}$ (calculated) b) $s = 4 \text{ mm}$ (suggested)

SolidWorks simulation of the main chamber with a 10 mm thickness based on its geometrical dimensions and internal pressure is clearly seen in Figure 7.a. Referring to the color code of overall part it is observed that the highest equivalent stress value is approximately 35MPa. Considering that flow stress of the material is 330MPa,

it can be said that the determined sheet thickness has a safety factor of 9.4. SolidWorks analysis of the chamber with a 4 mm sheet metal thickness is seen in Figure 7.b. The highest Von-Misses equivalent stress is around 107MPa according to color scale and the cabin has a safety factor of approximately 3 under internal pressure. There is no need to consider the maximum value of the color scale because there is no red region in the color code on the part. Furthermore, during SolidWorks analyses the maximum allowable pressure value was used but normally the cabin will be subject to the maximum allowable working pressure. Maximum allowable pressure (MAP) value is the maximum unit pressure permitted in a given material used in a chamber. Maximum allowable working pressure (MAWP) for a chamber is the maximum internal or external pressure permissible at the top of the vessel in its normal operating position. Cabins are not vulnerable to corrosive environments because sandblasting and painting will be applied to them. Thus, it can be said that a 3 mm corrosion tolerance is not completely necessary for a hyperbaric diver chamber.

SolidWorks simulation of the outside torispherical head with a 10 mm thickness based on its geometrical dimensions and internal pressure is shown seen in Figure 8.a. Referring to the color code of overall part it is observed that the highest equivalent stress value is approximately 40MPa. Considering that flow stress of the material is 330 MPa, it can be said that the determined head thickness has a safety factor of 8.3. The safety factor is 5.5 when it is considered the areas with orange/red color code on the part. On the other hand, the SolidWorks analysis of the torispherical head with a 6 mm sheet metal thickness is seen in Figure 8.b. The highest Von-Misses equivalent stress is about 70MPa whole part according to color scale and the cabin has a safety factor of approximately 4.7 under the internal pressure. If it is considered the small orange color regions of the part, the Von-Mises equivalent stress is determined about 110 MPa and has a safety factor of 3 as desired.

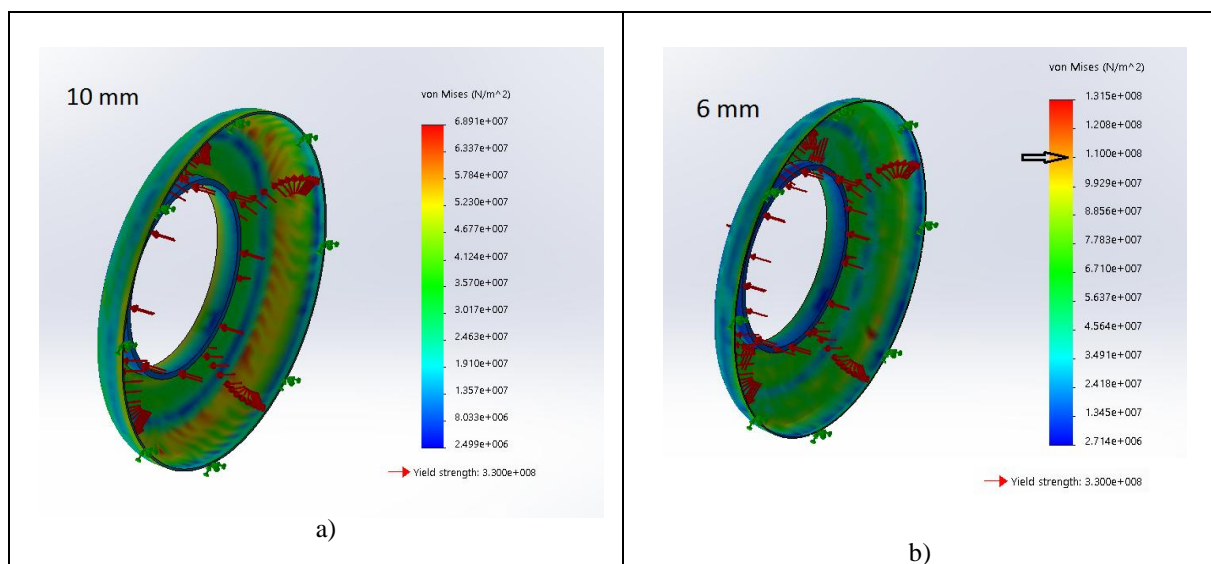

Figure 8: Stress analysis results of torispherical head
a) $s=10$ mm (calculated) b) $s=6$ mm (suggested)

Another important part of the hyperbaric oxygen chamber is the door and its radius. Results of analysis which have been done according to the thickness of 28 mm calculated for the door thickness and 12 mm calculated for the radius are shown in the Figure 9.a and 9.c respectively. According to Fig. 9.a the existing inner pressure creates an equivalent stress of approximately 35 MPa on the door material. The flow stress of the door material is 265 MPa. Thus, the porthole is 7.5 times safely. Furthermore the door is 4 times safely even the small red areas on the part are taken into account. According to Fig. 9.c the highest equivalent stress value is approximately 35 MPa and that the determined door radius thickness has a safety factor of 9.5 because the flow stress of the door radius material is 330 MPa. Door radius thickness is 5 times safely also when the maximum equivalent stress value on the color scale is taken into consideration.



In Figure 9.b and Figure 9.d it is shown that the SolidWorks analysis in which the maximum equivalent stress is one third of the yield stress of the door and the door radius material. In Figure 9.b the SolidWorks analysis of the door with a 18.5 mm sheet metal thickness is seen. Referring to the color code of overall part it is observed that the highest equivalent stress value is approximately 50MPa. and considering the flow stress of the material is 265MPa, the determined door thickness has a safety factor of 5.3. The safety factor for door material is 3 when it is considered the areas with red color code on the part as seen in Fig.9.b.

In Figure 9.d. it is seen that the inner pressure creates an equivalent stress of approximately 55 MPa on the door radius material of which the thickness is 7 mm. This means that determined thickness according to SolidWorks analysis is about 6 times safely. If it is considered the small red color regions of the part, the Von-Mises equivalent stress is determined about 111MPa and has a safety factor of 3 as desired.

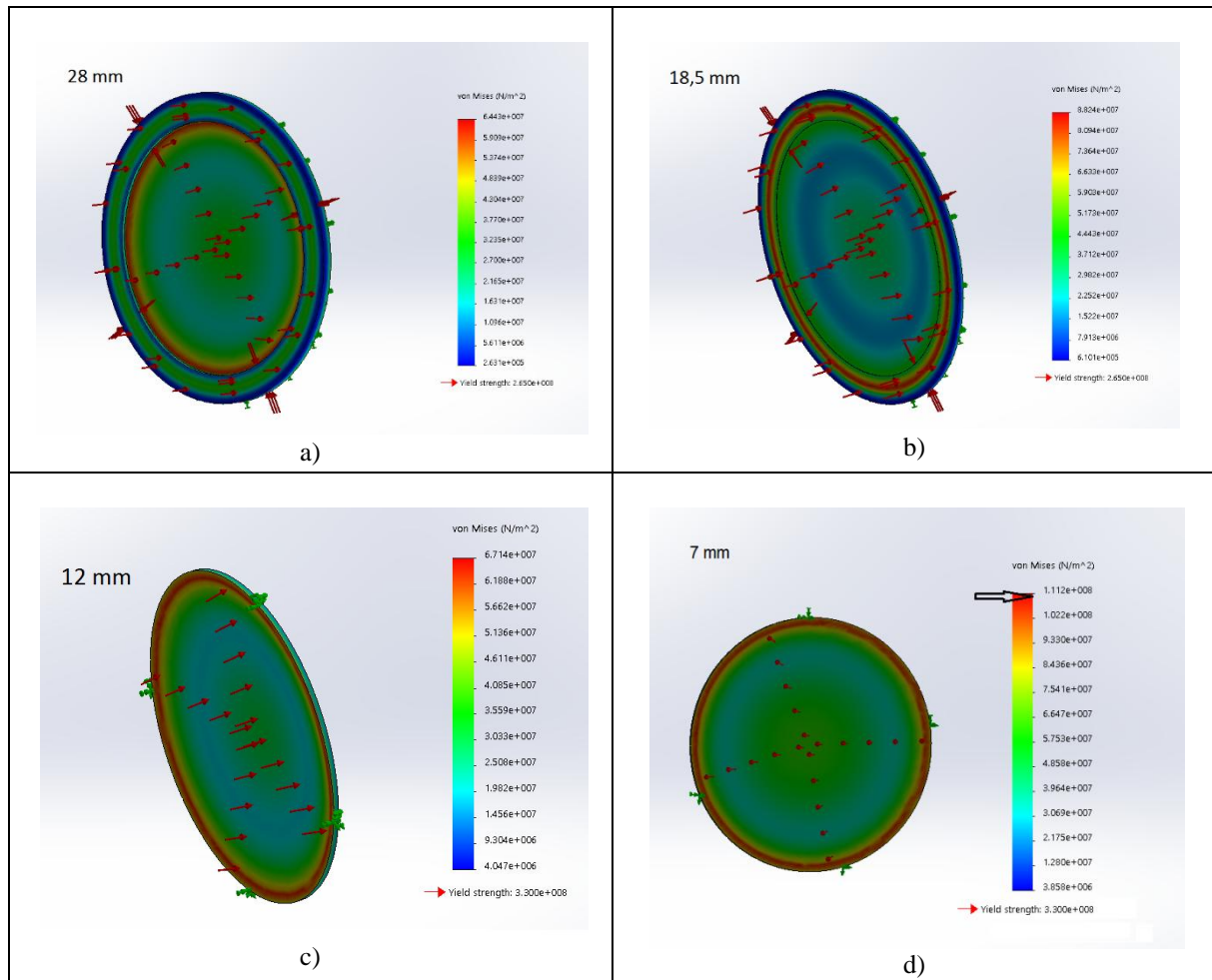

Figure 9: Stress analysis results of door and its radius

- a) $s=28$ mm (calculated door thickness)
- b) $s=18.5$ mm (suggested door thickness)
- c) $s=12$ mm (calculated door radius)
- d) $s=7$ mm (suggested door radius)

The existing stress distribution for the thickness of the wall remained outside the medical lock is shown in Figure 10.a. Calculated thickness value of the medical lock outside wall is 22 mm. When the color scale is examined it is seen that the maximum equivalent stress value is about 10 MPa. The flow stress of the material used is 206 MPa, accordingly the wall thickness of the material chosen is approximately 20 times safety. The SolidWorks analysis of the medical lock outside wall with a 8.5 mm sheet metal thickness is seen in Figure 10.b. The highest Von-Misses equivalent stress is about 40MPa whole part according to color scale and the cabin has a safety factor of approximately 5 under the internal pressure. If it is considered the small orange/red color regions of the part, the Von-Mises equivalent stress is determined about 68 MPa and has a safety factor of 3.

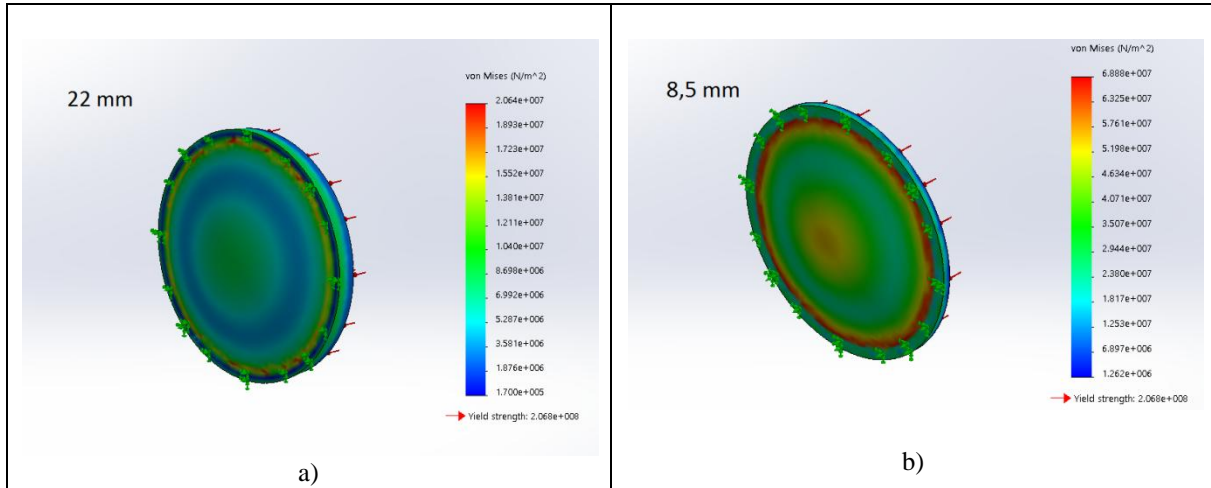

Figure 10: Stress analysis results of medical lock outside wall
 a) $s=22\text{ mm}$ (calculated) b) $s=8.5\text{ mm}$ (suggested)

Results of analysis which have been done according to the thickness of 79 mm calculated for the porthole flange are shown in the Figure 11.a. The existing inner pressure creates an equivalent stress of approximately 6 MPa on the porthole material. The flow stress of the porthole material so chosen is 265 MPa. Thus, the porthole is 44 times safely. If it is considered the outer edge of porthole the equivalent stress is 9.7 MPa and the porthole is 26 times safely. It is possible to reduce the thickness of porthole flange about 35-40 mm but the thickness could be chosen at least 59 mm. because 40 mm thick acrylic flat disk enters into the porthole flange. In Figure 11.b. the SolidWorks analysis of the flange with a 59 mm thickness is shown. According to analysis this thickness is at least 19 times safely because maximum equivalent stress is 14 MPa while flow stress of the material is 265 MPa.

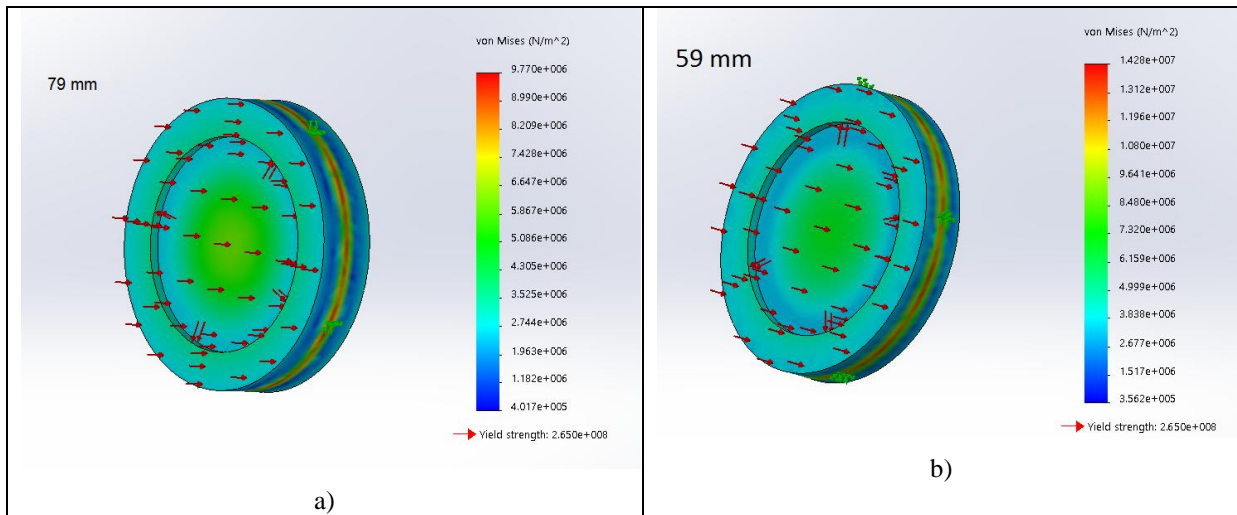

Figure 11: Stress analysis results of porthole flange
 a) $s=80\text{ mm}$ (calculated) b) $s=59\text{ mm}$ (suggested)

5. Weight and Cost Analysis

The main structural parts of a hyperbaric oxygen chamber have a very high safety factor, as can be seen from the calculated thickness values according to the AD2000 Merkblatt standards. It is also shown in the diagrams above that the thicknesses of these parts can be determined with the safety factor of 3 with SolidWorks analysis. Weight values and prices are given in the following table according to results by the DBF and the DBA.

Table 1: Comparison of the weight and total cost values

Part	DBF Weight (kg)	DBA Weight (kg)	Differ (kg)	Unit Price (\$/kg)	Total Price by DBF (\$)	Total Price by DBA (\$)	Differ. (\$)
Main body	1121	450	671	0.63	706	283	423
Torisp. head	197	118	79	0.63	124	74	50
Door	88	41	47	0.63	55	25	30
Door radius	39	22	17	0.63	25	14	11
Medical lock	10	3	7	0.63	6	2	4
Porth. flange	55	41	14	0.63	35	26	9
		Total	835 kg			Total	527 \$

Weight values of sheet metal thicknesses calculated according to AD2000 MB standards and suggested by authors in order to DBA are given in Table 1. It is clearly seen that there are considerable advantages in design of a HBO chamber by using DBA for basic structural components. Based on calculations total weight of the selected parts for chamber is 1510 kg. However, considering the suggestion of authors, the cabin weight decreases to 675 kg therefore 835 kg of material will be saved. Thus the cabin weight is reduced by 55%. Therefore, it is apparent that the sheet metal thicknesses selected according to stresses provide an advantage in terms of weight. On the other hand production costs of the HBO chamber will be reduced also in order to low material usage. When sheet metal thicknesses suggested by authors are considered, total cost decreases by 55%. Table 3 reveals that the total cost of the sheet thicknesses in order to DBF is \$951 while it is \$424 in the case of DBA. As a result, it is clearly observed that considering DBA offers great advantages over DBF in terms of lightness and production cost. The company cooperated in the presented study has the capacity to produce 30 cabins/per year. Thus, material gain is obtained approximately 25 ton/per year and total cost is reduced as 16.000\$/per year.

6. Conclusion

Design of most significant components for multiplace HBO chamber and determination of thicknesses of material by means of DBF and DBA have been realized and advantages of DBA for the production of these types of cabins have been well presented in this study. As known, the material thickness values obtained as the result of calculations made according to AD2000 MB standards have got rather high safety factors. As it was also seen at the results of SolidWorks analysis, these coefficient values range from 5 to 44. Because metal-based cabins are subject to passivation and painting, it was revealed that cabins could be confidently produced for sheet metal thicknesses lower than calculations based on standards. Moreover, a safety factor is included in empirical calculations. Thus, it will be determined for these components in accordance with the agreement and understanding to be reached between manufacturer and customer, for example a safety coefficient between 2 and 3 times will also pull down costs to lower level significantly. The thicknesses suggested by authors are more reliable than those presented numerically in the study. The use of DBA instead of DBF decreases the total cost by 55% also.

References

- [1]. Chang, K.H. (2015). Design with SolidWorks, *Design Theory and Methods Using CAD/CAE*, 407-447.
- [2]. Javadi, Y., Pirzaman, H.S., Raeisi, M.H., Najafabadi, M.A. (2014). Ultrasonic stress evaluation through thickness of a stainless steel pressure vessel. *Int. J. of Press. Ves. and Piping*, 123-124:111-120.
- [3]. El-Reedy, M.A. (2011). *Construction management and design of industrial concrete and steel structures*, CRC Press, Taylor & Francis Group.
- [4]. Jorge, R.M.N., Fernandes, A.A. (2001). Design of a steam-heated sterilizer based on finite element method stress analysis, *Int. J. of Press. Ves. and Piping*, 78:627-635.
- [5]. Trivedi, G. (2016). Design by analysis versus design by rule, *Equipment and System Design*, SS-4.



- [6]. Middletown, J., Owen, D.R.J. (1977). Automated design optimization to minimize shearing stress in axisymmetric pressure-vessels, *Nuclear Eng and Des.*, 44(3):357-366.
- [7]. Brabin, T.A., Christopher, T., Rao, B.N. (2010). Finite element analysis of cylindrical pressure vessels having a misalignment in a circumferential joint, *Int. J. of Press. Ves. and Piping*, 87:197-201.
- [8]. Glodova, I., Liptak, T., Bocko, J. (2010). Usage of finite element method for motion and thermal analysis of a specific object in SolidWorks environment, *Procedia Engineering*, 96:131-135.
- [9]. Yeom, D.J., Robinson, M. (1996). Numerical analysis of the elastic-plastic behaviour of pressure vessels with ellipsoidal and torispherical heads, *Int.J.ofPress.Ves.and Piping*, 65:147-156.
- [10]. Wilczynski, B. (1998). Shape optimization of thin elastic shell of revolution with axisymmetric loading, *16thConfPoliopt CAD Koszalin*, 396-403.
- [11]. Kedziora, S., Kubiak, T. (1999). Application of FEM for calculation of stresses and strains in pressure tanks, *Dozor Techniczny*, 4:83-85.
- [12]. Widera, G., Wei, Z. (1999). Parametric finite element analysis of large diameter ratio shell intersections subjected to internal pressure, *Trans.of the 15thIntConf on Struc.Mech.in reactor Tech. SMIRT15*, Seoul, 129-136.
- [13]. Petrovic, A. (2001). Stress analysis in cylindrical pressure vessel with loads applied to the free end of a nozzle, *Int. J. of Press. Ves. and Piping*, 78:485-93.
- [14]. Diamantoudis, A. Th., Kermanidis, Th. (2005). Design by analysis versus design by formula of high strength steel pressure vessels: a comparative study, *Int. J. of Press. Ves. and Piping*, 82:43-50.
- [15]. Mackenzie, D., Camilleri, D., Hamilton, R. (2008). Design by analysis of ductile failure and buckling in torispherical pressure vessel heads, *Thin-Walled Structures*, 46:963-974.
- [16]. Gong, J., Tao, J., Zhao, J., Zeng, S., Jin, T. (2013). Effect of top stiffening rings of open top tanks on critical harmonic settlement, *Thin-Walled Structures*, 65:62-71.
- [17]. Jeyakumar, M., Christopher, T. (2013). Influence of residual stresses on failure pressure of cylindrical pressure vessels, *Chinese Journal of Aeronautics*, 26(6):1415-1421.
- [18]. Lu, M.H., Yu, J.S. and Chen, J.J. (2014). The effect of analysis model on the stress intensity calculation for the nozzle attached to pressure vessel under internal pressure loading, *Int. J. of Press. Ves. and Piping*, 117-118:9-16.
- [19]. Al-Gahtani, H., Khathlan, A., Sunar, M., Naffa'a M. (2014). Local pressure testing of spherical vessels, *Int.J.of Press. Ves. and Piping*, 114-115:61-68.
- [20]. Murtaza, U.T., Hyder, M.J. (2015). Design by analysis versus design by formula of a PWR reactor pressure vessel, *Proc. of 1th Int Multi Conference of Engineers and Computer Scientist, IMECS 2015*, Hong Kong, 2:942-946.
- [21]. Altınbalık, M.T., Kabak, T. (2015). Strength and cost analysis of stainless steel uses in the multiplace hyperbaric chambers, *Proc. of 15thInt Sci. Conf. UNITECH'15*, Gabrovo, 3:137-143.
- [22]. Altınbalık, M.T., Kabak, T. (2016). Penetrators design characteristics of a multiplace hyperbaric chamber for divers, *Proc. of 16thInt Scientific Conf. UNITECH'16*, Gabrovo, 3:143-148.
- [23]. Verghese, G., Verma, R., Bhutani, S. (2013). Hyperbaric oxygen therapy in the battlefield, *Medical J. Armed Forces India*, 69:94-96.
- [24]. Altınbalık, T., Kabak, T. (2016). PMMA Usage in a Hyperbaric Pet Chamber: A Contribution to Design and Comparative Cost Analysis for Different Materials, *International Journal of Research in Engineering and Applied Sciences*, 6(7):57-69.

