



Portable Thermoelectric Waste Heat Recovery System

Sharwari Dandekar, Viraj Chavan, Vaishnavi Gaikwad, Ujwal Chaudhari and
Rajesh V Kale

Department of Mechanical Engineering, Rajiv Gandhi Institute of Technology, Mumbai, India-400063
sharwari.dandekar@gmail.com

ABSTRACT

In view of the fast depleting resources for power generation, search for alternate renewable energy resources and their reutilization has gained importance. Thermoelectric power generation, a concept based on Seebeck effect is the basic principle of this paper. The paper aims to conduct research in the domain of thermoelectric generation and come up with a unique model to effectively harness it. The paper comprises of the design and testing of a portable Thermoelectric Generator prototype under various conditions. The direct conversion of thermal energy into electricity and a wide range of thermal sources make the system highly reliable, user friendly and compact. The prototype thus designed gives a significant output even at low temperature differences, proving the feasibility of thermoelectric generation as a waste heat recovery system.

Key words: Thermoelectric, power, generation, renewable, Seebeck effect

INTRODUCTION

The basis of the paper and of thermoelectric power generation is Seebeck effect. Seebeck effect states that a temperature gradient between two dissimilar electrical conductors (bimetallic pair) results in the diffusion of charge carriers. The flow of charge carriers between the hot and cold regions in turn creates a voltage difference. Waste heat trapped from various sources can thus be utilized to generate electricity. The dissimilar conductors range from aluminum to platinum. However, the pair most suited is semiconductors such as bismuth telluride or lead telluride. Thermoelectric power generators (TEG) consist of a major part called the thermoelectric power modules. These modules comprise of a bimetallic strip of n-type and p-type semiconductors embedded in a ceramic sheath for better protection and support. These modules serve the same purpose obeying the theory of Seebeck effect and were utilized in the prototype for creating a robust, compact and efficient product. Prototype design and optimization was done to arrive at an ideal system for waste heat recovery. We then conducted experiments at different temperatures for a wide range of thermal sources to analyze the feasibility and competitiveness of the technology.

A literature survey was conducted for the purpose of harnessing the best effects of influencing parameters. This survey began with the study on the paper by Lieu and Chan [1]. The paper highlighted the importance of increasing the temperature difference for a greater potential difference. Various TEG modules were studied in this paper and their results were drawn out. This provided us with sufficient evidence that photovoltaic cells (PV) would be costlier than Direct Heat to Electricity (DHE) cells for the same amount of power generated. The research for the prototype is based on the analysis of various parameters and the importance of Seebeck coefficients and how they impact the efficiency of a TEG module [2]. Based on the conclusions acquired from the paper by Duh and Dungan [3], we gathered and analyzed the Seebeck coefficients of various materials. The paper claimed that the difference in Seebeck coefficients have a positive effect on the power generated. This was corroborated with the study conducted which further cemented the experimental and the project work. This paved way for understanding how Seebeck coefficient can be improved by doping. This paper also resulted in increasing our scope for application as the evidence stated uses which were otherwise unknown.

The research continued onto studying another technical paper for the development on solar energy generator [4]. From here, we modified the sources of temperature difference and decided on designing a model that would harness waste energy as well. This idea was strengthened by the studies conducted previously and jotted down in

the Home made energy using gas stove paper [5] and the car waste heat recovery systems paper [6]. This paper was based on the development of electricity at home using the waste energy from a gas stove. It thus increased applications making the idea more practical for implementation. The technology was analysed from a commercial point of view in the Komatsu paper [7]. The cost analysis, market research and feasibility analysis proved the competitiveness of thermoelectric power as a non-conventional source in the market. It also made the idea of this energy source as practical and dependent source more plausible than earlier believed [8].

DESIGN AND CONSTRUCTION

As stated earlier, thermoelectric power modules were used in the system. By studying the various commercially available Thermoelectric Cooler (TEC) and Thermoelectric Generator (TEG) modules, we arrived at TEC-120760 which best suited our purpose [9]. The research aimed to design and fabricate a layered structure of TEC-120760 fixed between aluminum plates embedded amidst silicon sealant. Aluminum was selected due to its low cost, easy availability and high thermal conductivity at 205 W/mK. To fix the aluminum plates to the TECs, we used thermal paste. Thermal paste adheres to surfaces well and thus helped in greater heat dissipation. To thermally seal the model, we used silicon sealant which acted as an insulator by not allowing heat to flow from the hot side to the cool side and vice versa. It also provided rigidity to the model. The cooler surface of the TEC module which was left open to the atmosphere was covered by a heat sink. The heat sink helps maintain a cooler surface which allows for a greater temperature difference to be set up, leading to larger potential difference. The wires from the fixed TEC were pulled out from a single side, towards an electric board. Each TEC gives an output of 1-5V according to the temperature difference established. Voltage regulators were fixed on the electric board. These regulators were used to regulate the voltage obtained from the TECs to a constant of 5 volts. Eight such regulators were used, each connected to an individual TEC. All these outputs of 5 volts each were then connected in series in two branches of four TECs to obtain a total output of 40 volts.

Thus, the components and their specifications include:

- 8 TEC12076 Modules with dimension of 40mm×40mm.
- Aluminum plate of 250mm×180mm.
- 4 rectangular aluminum plates of 220mm×40mm.
- Heat Sink of 250mm×180mm
- Silicon Sealant
- Thermal paste
- 8 voltage regulators on an electric board
- Single Strand Wires
- Insulation Tape

Four individual TECs were fixed at equidistant positions with the help of thermal paste between two rectangular aluminum plates of the dimension 220mm×40 mm. The purpose of the smaller aluminum plates was to protect the wires from heat. Two branches were made and the combined modules-plate was then arranged on the 180mm×250mm larger plate using the thermal paste as shown in Fig.1. Aluminum heat sink was similarly attached using thermal paste. The proposed model and the actual fabricated prototype are shown in Fig.2 and Fig.3 respectively.



Fig.. 1 Module-Plate combination attached



Fig. 2 Proposed model to Aluminum plate



Fig. 3 Fabricated prototype

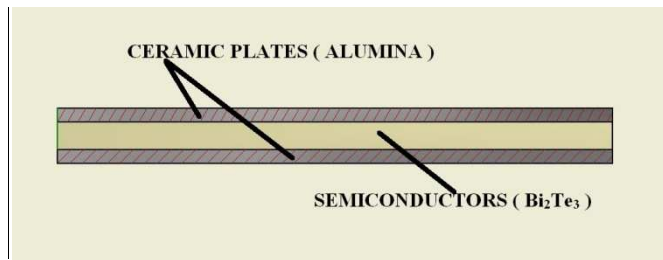

Fig.. 4 Plate TEC system

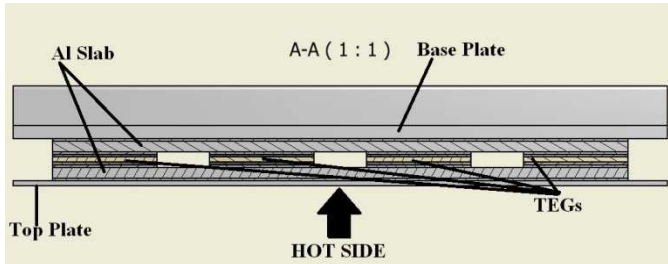

Fig. 5 Cross section of model

Areas of individual layers:

- Area of the top plate: $250 \times 180 = 45000 \text{ mm}^2$
- The first and fourth layer of thermal paste that covers the aluminium slab,
- Area: $220 \times 40 = 8800 \text{ mm}^2$
- Area of Aluminium slab: $220 \times 40 = 8800 \text{ mm}^2$
- The second and third layer of thermal paste cover the TEC modules per branch,
- Area: $4 \times 40 \times 40 = 6400 \text{ mm}^2$
- Area of TEC module: $40 \times 40 = 1600 \text{ mm}^2$
- Area of Base Plate: $250 \times 180 = 45000 \text{ mm}^2$
- Area of fin: $3 \times 250 \times 25 = 18750 \text{ mm}^2$

Thickness of each layer:

- Thickness of the top plate: 2 mm
- Thickness of Aluminium slab: 4 mm
- Thickness of thermal paste: 1 mm
- Thickness of ceramic layer: 1 mm
- Thickness of semiconductor layer: 2 mm
- Thickness of Base Plate: 5 mm

On the basis of the material used, the thermal conductivity (K) of the materials is as follows:

- Top plate = 205 W/mK = of Aluminium Slab
- Thermal paste = 1.2 W/mK
- Ceramic plate (alumina) = 32 W/mK
- Semiconductor = 1.2 W/mK
- Cast Aluminium Base Plate: 150 W/mK
- Coefficient of Convection = 15 W/mK

To justify the use of fins, we analysed the system and calculated the heat flow, boundary temperatures without the fin. Following assumptions are made:

- Heat Transfer due to silicon sealant is negligible.
- The TECs are assumed to be 3 plate system, with bismuth telluride embedded between ceramic plates as shown in Fig.4.

The cross sectional view of the model is shown in Fig.5. The equivalent electrical system is shown in Fig.6.

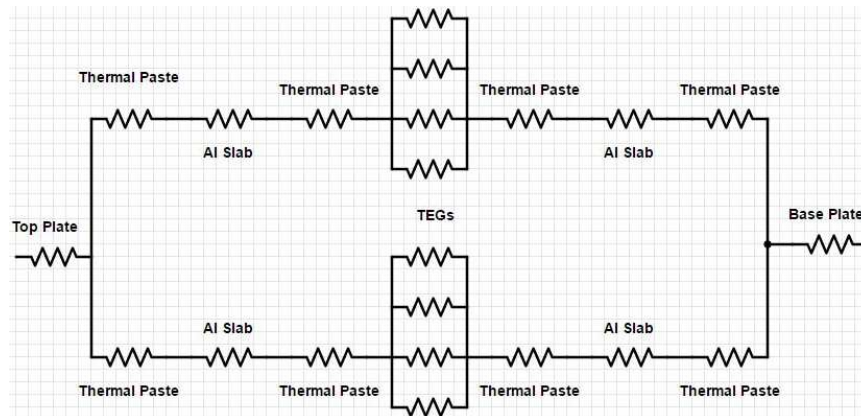

Fig. 6 Electrical circuit

Treating the model as a composite wall, we performed thermal calculations.

We found out the equivalent conductive resistance which was 0.3612 K/W and convective resistance as 1.48 K/W. Total Resistance (without fins) = 1.8426 K/W

Now, Heat flow rate (Q) without fin;
$$Q = \frac{\text{Temperature of hot side} - \text{Temperature of room}}{\text{Summation of Resistances}}$$

Where, Temperature of hot side = 80°C and temperature of room = 27°C

Therefore,
$$Q = 28.763 \text{ K/W}$$

Interface Temperature;

Let T_1 be the temperature at the interface,
$$Q = \frac{\text{Temperature at Interface} - \text{Temperature of room}}{\text{Equivalent Resistance}}$$

Thus,
$$T_1 = 69^\circ\text{C}$$

Thus, we can conclusively state that the temperature without the fins (heat sink) at the outer wall interface was 69°C and was thus very high. The use of fins to reduce this high temperature was thus justified. By installing fins, the experimental results show that the temperature at the outer wall can be dropped to an average of 33°C. Thus a drop of 36°C was obtained for the operational temperature. This helps increasing the efficiency of the system since the temperature difference is directly proportional to the voltage generated.

The previous model was optimized and following changes were made:

1. Double layer of insulation using an insulation sheath.

Reason: The insulation protects the wires from any possible mechanical damage or electrical failure making the model durable for longer use.

2. The reduced use of the silicon sealant.

Reason: The previous design included the spread of the silicon sealant throughout the aluminum plates, leaving very little space for clamping or holding the device. By this modification, we can ensure that there is sufficient space to not only hold the model but also to clamp it. This helps increasing its application, avoids unwanted burns due to the hot side and makes it more user friendly.

As explained before the basic principal behind the operation of the project is Seebeck Effect. The prototype which resembles a plate or lid can be easily placed over a heat source to channelize all the energy which is otherwise wasted. The heat from the hot source heats the hot end of the model. The cold surface is exposed to the atmosphere. Between these surfaces, we have placed the TEC 12076 modules which are fixed between aluminium plates and embedded amidst the silicon sealant. Thus when the hot surface receives heat, the aluminium plates transfer the heat to the hot side of the TECs and a temperature difference is set up at the TEC modules. This causes the setup of a potential difference across the ends of the TEC module resulting in the flow of electricity. For a larger useable voltage, the prototype has 8 TECs with separate individual regulators, connected 4 in a series and two such branches are formed. The output encountered from a temperature gradient of 25°C is close to 20.5 volts from each branch. Thus each branch provided enough energy to light up an array of 60 LEDs (20 X 3 connected in parallel) and be used for lighting applications. In order to test the validity of the design we tested the system for a few household and commercial purposes.

RESULTS AND DISCUSSIONS

The first testing was done with a household induction stove as shown in Fig. 9. In accordance with the aim of waste heat utilization, we used the heat from a cooking pot by employing the prototype as a lid. The temperature gradient set up a potential difference. The variation of potential with change in the temperature gradient was plotted and results are shown in Fig.10. To know the system responsiveness, we recorded the rise in output voltage over a period of time until the output reached its maximum value. The graph is shown in Fig.11. Taking the testing further, we analysed the drop in voltage output once heat is removed. We thus plotted the fall in output potential with a decrease in temperature gradient shown in Fig.12 and the drop of output voltage over a period of time as shown in Fig.13. Storing the output charge during working will make the product more effective.



Fig. 9 Test on induction stove

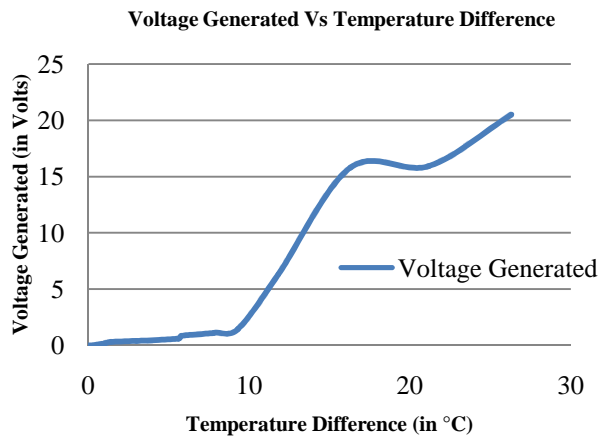

Fig. 10 Voltage generated from TEC model vs temperature Difference

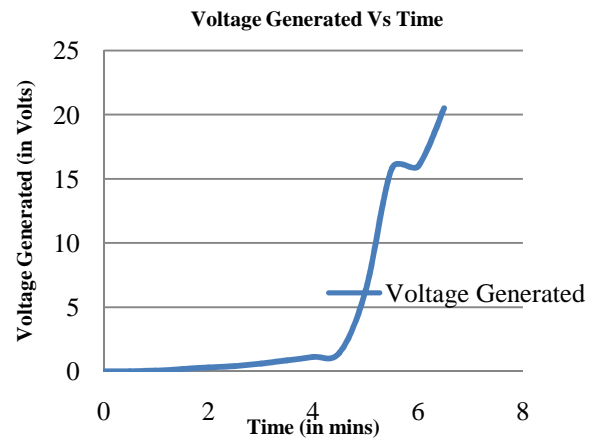

Fig. 11 Voltage generated from TEC model vs time

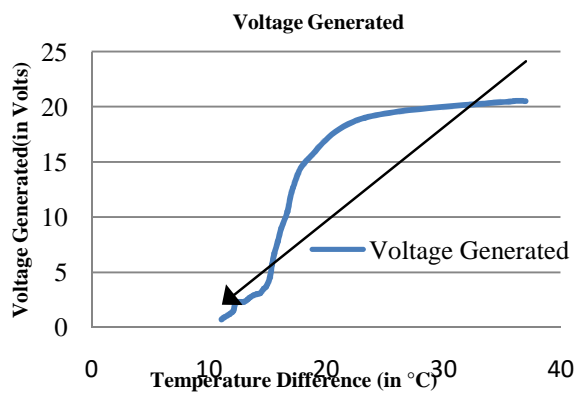

Fig. 12 Voltage generated from TEC model Vs temperature difference after removal of heat

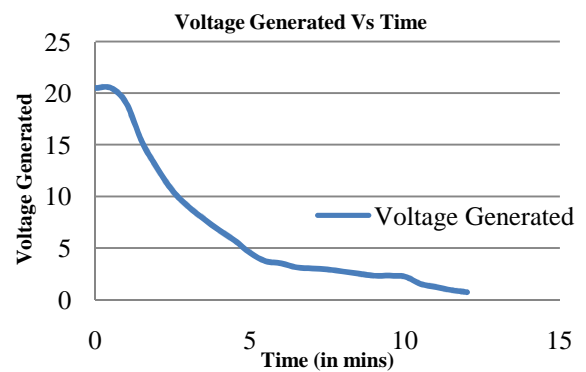

Fig. 13 Drop of voltage generated for a time period

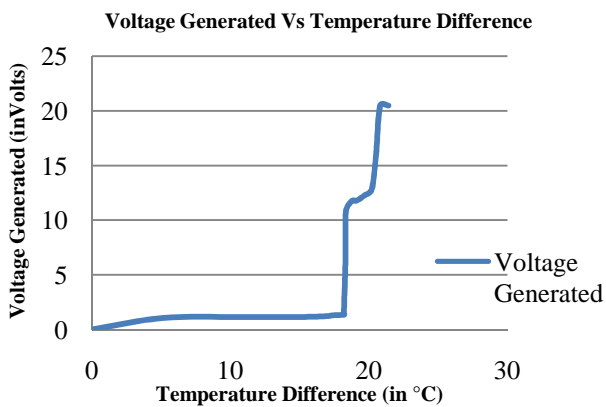

Fig. 15 Voltage generated by TEC model vs time

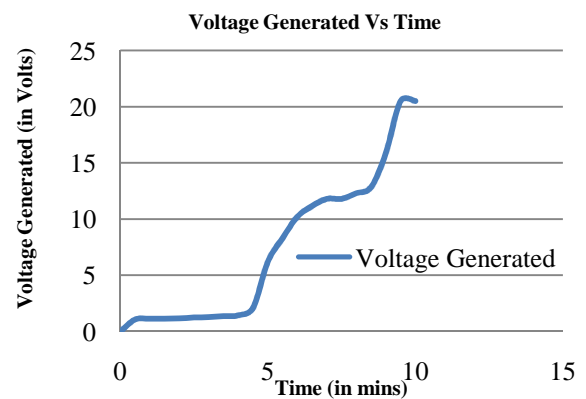

Fig. 14 Voltage generated by TEC model vs time



Fig. 16 Test on ice slab

To further increase the scope of thermoelectric generator, we employed it at lower temperatures. Since the setup works on a temperature gradient, we reduced the temperature at the cold junction rather than increasing the temperature at the hot junction as done in the previous testing. The model was kept on a slab of ice as shown in Fig.16. We recorded the potential difference setup as the temperature of cold side drops and the thermal gradient increases. The results are shown in Fig.14. As recorded in the waste heat recovery experiment, we also plotted the output potential over a period of time till its maxima. The results are shown in Fig.15.

This finds application in cold storages and refrigeration units. Thus, along with heat recovery this system can also be used for low temperatures. For both experiments, we got an output of 20.5 V from each branch. We thus got a total output of 40V for a temperature difference of about 25°C. The results were summarized and are shown in Table -1. For the above temperature difference, the power obtained was approximately 3.2W across each branch.

Table -1 Results from Experimentation

Operating Parameters		Target Voltage (Volts)	Time to achieve the Target Voltage (minutes)	Temperature Difference (°C)
Hot side	Cold Side			
Hot air	Room Temp	20	6.5	26.3
Room Temp	Ice	20	9.5	21.4

CONCLUSION

From the above series of calculations, results and graphical representations, the following conclusions were inferred:

- Thermoelectric power is a viable option for waste heat recovery systems.
- The prototype channelizes the otherwise wasted heat energy from household applications such as cooking.
- The operation can occur at obtainable temperature differences and does not need special care.
- Even for low temperature difference of 20-25°C, the target output of 20V was achieved from each branch. This output sufficiently lights up 20 branches of 3 high intensity LEDs.
- Power of 3.2 W can be obtained from a single branch which is sufficient for low power consumption applications.
- The output can be enhanced with a larger temperature difference. This temperature difference can be obtained from other sources as well; for example heated automobile engine or solar heat.

This particular prototype channelizes waste energy from our everyday activities. One can think of modifying the model into storing and charging itself from heat generating applications such as motors, engines, air conditioners and many others. This not only marks the use of the model in rural areas but also urban areas which are hit by regular power cuts. Additionally, if one extends the application of the model to the reverse Seebeck Theory also known as the Peltier Theory, then an addition application can come to use. According to the Peltier theory, when a potential difference is provided across the ends of a bimetallic strip, a temperature difference is setup. Thus if the model is provided with electricity, then the cold side of the model can serve as a refrigerating unit for storage of perishable products. Similarly, the hot side of the unit can act as a hot plate for the purpose of heat generation. The future scope of the unit is thus vast and has great potential if rightly pursued and rigorously followed.

REFERENCES

- [1] Changwei Liu, Pingyun Chen and Kewen Li, KW Thermoelectric Generator for Low-temperature Geothermal Resources, *Thirty-Ninth Workshop on Geothermal Reservoir Energy, Stanford*, 2014, SGP-TR-202, 1-12
- [2] T Stephen John, High Efficient Seebeck Thermoelectric Device for Power System Design and Efficiency Calculation: A Review of Potential Household Appliances, *International Journal of Computer Applications*, 2014, 97 (18), 37-42
- [3] Allison Duh and Joel Dungan, Thermoelectric Power Generation, 2013.
- [4] Taleb M Maslamani, Abdu Idris Omer and MA Majid, Development of Solar Thermoelectric Generator, *European Scientific Journal*, 2014, vol 10, 123-134.
- [5] AP Rammohan and HM Manjunath Swamy, Home Made Electricity from Gas Stove, *International Journal of Engineering Research and Development*, 2013, 8 (6), 29-34.
- [6] B Orr, A Akbarzadeh, M Mochizuki and R Singh, A Review of Car Waste Heat Recovery Systems Utilising Thermoelectric Generators and Heat Pipes, *Applied Thermal Engineering*, 2015, 1-6
- [7] Seiji Sano, Hiroyuki Mizukami and Hiromasa Kaibe, Development of High-Efficiency Thermoelectric Power Generation System, *Komatsu Technical Report*, 2003, vol 49(52), 1-7
- [8] Ando Junior, Ferro, Izidoro, Maestrelli, Spacek, Mota and Malfatti C Schaeffer, Proposal of a Thermoelectric Microgenerator based on Seebeck Effect to Energy Harvesting in Industrial Processes, *International Conference on Renewable Energies and Power Quality*, Spain, 2014, 1-6
- [9] www.hebeiltd.com.cn/peltier.datasheet/TEC1-12706.pdf