

ЕКСПЛУАТАЦІЯ ТА РЕМОТ ЗАСОБІВ ТРАНСПОРТУ

UDC 629.424.1.018-82:004.318

I. V. ZHUKOVYTSKYI^{1*}, I. A. KLIUSHNYK^{2*}

^{1*}Dep. «Electronic Computing Machines», Dnipropetrovsk National University of Railway Transport named after Academician V. Lazaryan, Lazaryan St., 2, Dnipro, Ukraine, 49010, tel. +38 (056) 373 15 89, e-mail ivzhuk@mail.ru, ORCID 0000-0002-3491-5976

^{2*}Dep. «Electronic Computing Machines», Dnipropetrovsk National University of Railway Transport named after Academician V. Lazaryan, Lazaryan St., 2, Dnipro, Ukraine, 49010, tel. +38 (056) 373 15 89, e-mail klugran@i.ua, ORCID 0000-0001-9939-0755

CHOICE OF THE OPTIMAL PARAMETERS OF MEASURING THE SHAFT ROTATION FREQUENCY OF THE HYDRAULIC TRANSMISSION OF THE LOCOMOTIVE USING MICROCONTROLLER

Purpose. The article provides for finding solution to the problem of developing and improving the means for measuring tachometric data of the previously created information and measuring system for testing hydraulic locomotive transmission by substantiating the optimal sensor design and signal processing algorithms. At the same time first of all it is necessary to start from the possibility of modifying the already existing test bench for hydraulic locomotive transmissions at the Dnipropetrovsk diesel locomotive repair plant «Promteplovoz». **Methodology.** In the work, the researchers proposed a methodology for modifying the sensor design and the algorithm for processing its signals. It is grounded on previous developments of tachometric sensor of the optical type on the basis of D-2MMU-2 sensor of the microprocessor automated test bench system of hydraulic locomotive transmission in the locomotive repair plant conditions. Selection of the necessary measurement algorithm and the number of sensor teeth is substantiated by calculating instrumental and methodological errors. Also, the studies aimed at identifying the source of interference in the measurement of rotational speed are described and solution for its elimination has been found. **Findings.** For the designed rotation speed sensor of the optical type based on the existing D-2MMU-2 sensor, the authors analyzed the dependence of the methodological and instrumental errors. Based on the obtained data more rational variant of the rotation speed calculation algorithm is proposed, and the number of teeth of the sensor disk is justified. Further, the main source of measurement interference was established and a method for improving the hardware of the hydraulic locomotive test bench was proposed. **Originality.** There were conducted the studies according to the methodological and instrumental errors of the designed rotation speed of sensor. The mechanisms of interference filtering arising from the sensor rotation speed fixing were proposed. Additional studies have shown the need for a hardware revision of signal conditioner scheme. **Practical value.** Conducted studies make it possible to establish a rational number of sensor disk teeth, which allows improving the measurement algorithm. It was also performed a hardware improvement of signal conditioner scheme from the sensor, helping to get rid of interferences. The results of measurements in studies are the initial data to perform further studies in order to determine the technical condition of hydraulic transmission UGP 750-1200 during factory testing after repair.

Key words: tachometer sensor; 2MMU-D-2; hydraulic transmission; hydraulic transmission test; testbench; information-measuring system

Introduction

Today in Ukraine, the hydraulic transmission is tested using the outdated test-benches designed in Soviet times, in particular at the repair plants of

diesel locomotives and military equipment with hydraulic transmission. Also, there is no standardization of the production of these test-benches.

As part of the work for improvement and modernization of the existing hydraulic transmis-

ЕКСПЛУАТАЦІЯ ТА РЕМОНТ ЗАСОБІВ ТРАНСПОРТУ

sion test-bench at DZRT «Promteplovoz» plant it was revealed that the installed thereon analogue control devices are out-of-date. In the first stage of development in accordance with the plant test program the most necessary and critical 13 process parameters were selected. Information about which received from the sensors is processed by the microcontroller and PC [9].

Information about the rotation frequency of the drive motor, the generator, the turbine shaft is measured using D-2MMU-2 tachometer sensors [6], which transmit the pre-processed analogue signal to a special converter and then to ATMELE microcontroller for its further processing and transmission by USB 2.0 interface to the computer [9].

D-2MMU-2 sensor is nothing but an alternator, which has a critical flaw – at relatively low speeds (established experimentally at about 80 min^{-1}) the voltage amplitude produced by the alternator is not sufficient for the normal error-free measurements (at speeds of about 60 min^{-1} , the amplitude is about 1V, and at 2000 min^{-1} – 40 V). It is clear that at very low speeds the amplitude will be several tens of millivolts. To measure such a low voltage in the plant conditions is practically impossible, since, firstly, long communication lines from the test-bench to the measuring equipment may have low voltage blanking and, secondly, at the plant there is a large number of different sources of electromagnetic interferences, which may be laid on communication lines and erroneously recorded as the beginning of rotary motion on the test-bench.

On the basis of available equipment of hydraulic transmission testbench it was designed the rotation frequency sensor of optical type based on the existing sensor 2MMU D-2 [13]. According to the results of plant tests using the sensor prototype it was established the necessary and sufficient time for scanning the control sensor microcontroller, which allowed making changes in the measurement algorithm.

Purpose

In the calculations, it was found that changes in instrumental and methodological errors [4], which may be a result of missing and/or averaging the averaging, require further investigation. Also, as a result of the tests, the measurement statistics were obtained, which indicates the presence of interfer-

ence that requires the development of filtering mechanisms. It is necessary to identify the exact nature of the interference, which in turn can simplify, and, perhaps, completely eliminate the filtering mechanisms by making corrections to the hardware and software part of both the sensor and its interface circuit with the computer of the test bench.

To improve the designed sensor [13] (in order to choose a rational number of the disk teeth and the optimal algorithm for calculating the rotational frequency), it is necessary to calculate the instrumental and methodological errors that arise during the measurements. Obviously, the instrumental error should increase in proportion to the increase in the number of teeth (due to inaccuracy in their manufacture), and the methodological error on the contrary should fall with the increase in the number of teeth.

Methodology

To calculate the instrumental error, let us represent the calculation of the rotation frequency ω using the known formula:

$$\omega = \frac{L}{2\pi R\tau} \cdot 60 \text{ [min}^{-1}\text{]}, \quad (1)$$

where ω – is the measured rotation frequency [min^{-1}]; L – arc length between the teeth [mm]; R – distance from the disc center to the middle of the tooth height [mm]; τ – propagation time of the infrared ray of optocoupler of the arc L (period of the signal) [sec].

If the measurement error τ is neglected, then the relative measurement error [13] has the form:

$$\varepsilon = \frac{\Delta_L}{L}, \quad (2)$$

where Δ_L – is the difference between the actual and theoretical length of the arc L [mm].

Substituting (1) in (2), it is obtained a formula for calculating the relative error (instrumental), taking into account the dependence on the number of teeth:

$$\varepsilon_{inst} = \frac{\Delta_L N}{2\pi R},$$

where N – is the number of teeth of the sensor disk.

When using the formula (1) for measuring the rotational frequency the acceleration that may oc-

ЕКСПЛУАТАЦІЯ ТА РЕМОНТ ЗАСОБІВ ТРАНСПОРТУ

cur is not taken into account, as a result of which a methodological error arises. To calculate the methodological error, we will calculate the rotational frequency using the following formula:

$$\omega = \frac{1}{\tau N} \cdot 60 \text{ [min}^{-1}\text{]}. \quad (3)$$

Without considering the instrumental error, the actual rotational frequency can be expressed in terms of the measured rotational frequency at the end of the next measurement period (under the condition of uniform acceleration) according to the formula:

$$\omega_{act} = \omega_{meas} + aT \text{ [min}^{-1}\text{]}, \quad (4)$$

where ω_{act} – actual rotational frequency [min^{-1}]; ω_{meas} – measured rotational frequency [min^{-1}]; a – acceleration [$\text{min}^{-1}/\text{s}^2$]; T – delay time introduced by the measurement algorithm [sec].

It follows from (1) that $T = \tau$.

It was calculated and established that the performance of all assembler commands involved in the measurements is quite small value. The influence of this error ε_{Δ} is illustrated in Fig. 1.

As it can be seen from Fig. 1, under the given technical conditions, this error is extremely small and it can be neglected.

In this case, the absolute methodological error will have the following form:

$$\Delta = \omega_{act} - \omega_{meas} \text{ [min}^{-1}\text{]}.$$

Taking into account (3) and (4), the formula for the relative (methodological) error is:

$$\varepsilon_{meth} = \frac{a \cdot 60}{\omega_{meas} n \left(\omega_{meas} + \frac{a \cdot 60}{\omega_{meas} n} \right)}.$$

The graphs of the dependence of the instrumental and methodological errors on the number of teeth in the disk with different input parameters are shown in Fig. 2 and Fig. 3.

As it can be seen from Fig. 2, approximately starting from the value of the rotational frequency equal to 200 min^{-1} , it is enough to use a wheel with one tooth (intersection of methodological and instrumental errors is the optimum point). Fig. 3 shows that at $\omega_{meas} = 20 \text{ min}^{-1}$, to minimize the error it is sufficient to use about 9 teeth. The acceleration a was chosen as high as possible.

Summarizing the obtained result, and also in order to simplify the calculating algorithm of rotational frequency, it was decided to modify the calculation algorithm as follows: up to 50 min^{-1} (valid at the average acceleration $a = 1.15 \text{ min}^{-1}/\text{s}^2$ [13]) to perform calculations as earlier, taking into account each period of the signal from the sensor (for a disc of 10 teeth). Starting from the rotational frequency greater than 50 min^{-1} it was decided to take into account the duration of ten signal periods from the sensor as one measurement period, i.e. simulate a single-tooth disc. This condition practically does not contradict the conclusions made in the work [13], as there it was justified the sufficiency of using every 8th sample of the rotational frequency. In the process of testing the projected sensor the interferences were detected (Fig. 4).

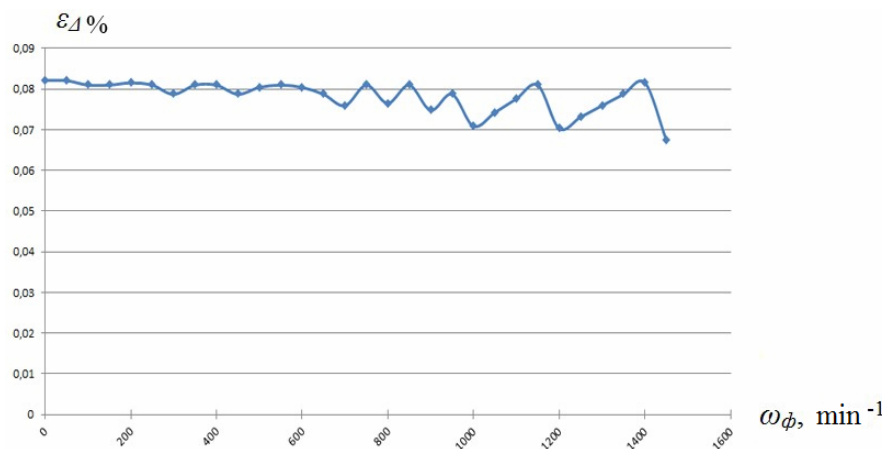

Fig. 1. Dependence of the deviation ε_{Δ} of the measured rotational frequency from the actual rotational frequency introduced by the execution time of the assembler commands of the microcontroller

ЕКСПЛУАТАЦІЯ ТА РЕМОНТ ЗАСОБІВ ТРАНСПОРТУ

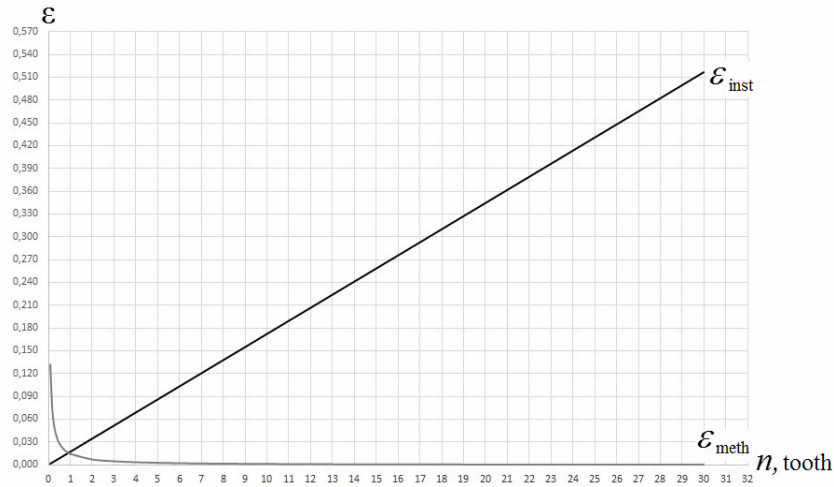

Fig. 2. The graph of the dependence of the instrumental and methodological errors on the number of teeth in the disk at $\omega_{meas} = 200 \text{ min}^{-1}$, $a = 10 \text{ min}^{-1}/\text{s}^2$, $\Delta_L = 2 \text{ mm}$

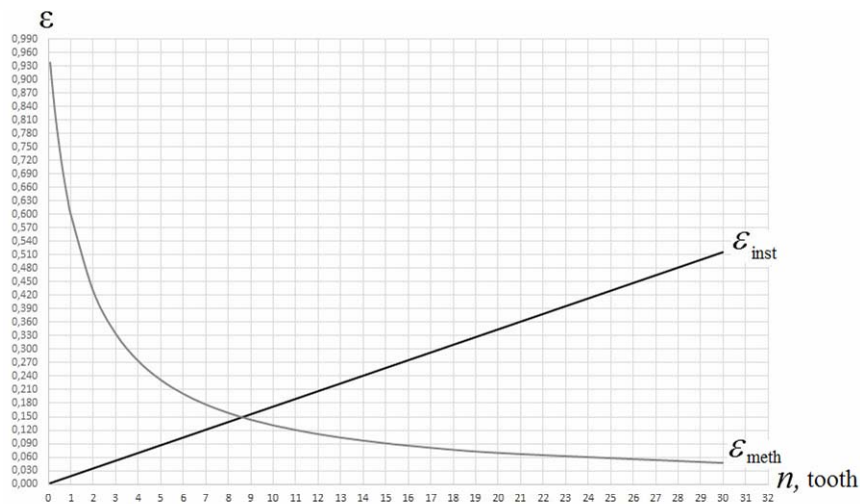

Fig. 3. The graph of the dependence of the instrumental and methodological errors on the number of teeth in the disk at $\omega_{meas} = 20 \text{ min}^{-1}$, $a = 10 \text{ min}^{-1}/\text{s}^2$, $\Delta_L = 2 \text{ mm}$

As can be seen from Fig. 4, there is some kind of interferences in the signal from the sensor, as indicated by the spectrum of the signal obtained using the fast Fourier transform [1, 5].

These low-frequency interferences are easily filtered, for example, by arbitrary finite impulse response (FIR) filter [5, 11]. For this purpose, the FIR filter of the 10th order was used filtering the frequencies up to 10 Hz. As one can see from Fig. 4 has filtered the supposed interferences partially. However, there are visible residual beatings of unknown origin. Of course it is impossible to assert that this interference is of a different nature or it is the specificity of the hydraulic transmission opera-

tion (high-precision reference sensor is not available at the factory). These residual interferences can also be easily filtered by moving average algorithm [12] for example, as it is shown in Fig. 5.

But the expediency of such an action is extremely doubtful. Firstly, it is unknown whether this is the interference (presumably, in the plant's environment there would be more high-frequency interferences). Secondly, it is possible that such deviations in the signal can be caused by some fault of the software or hardware parts of the designed test bench. As a result, it is necessary to conduct additional studies.

ЕКСПЛУАТАЦІЯ ТА РЕМОНТ ЗАСОБІВ ТРАНСПОРТУ

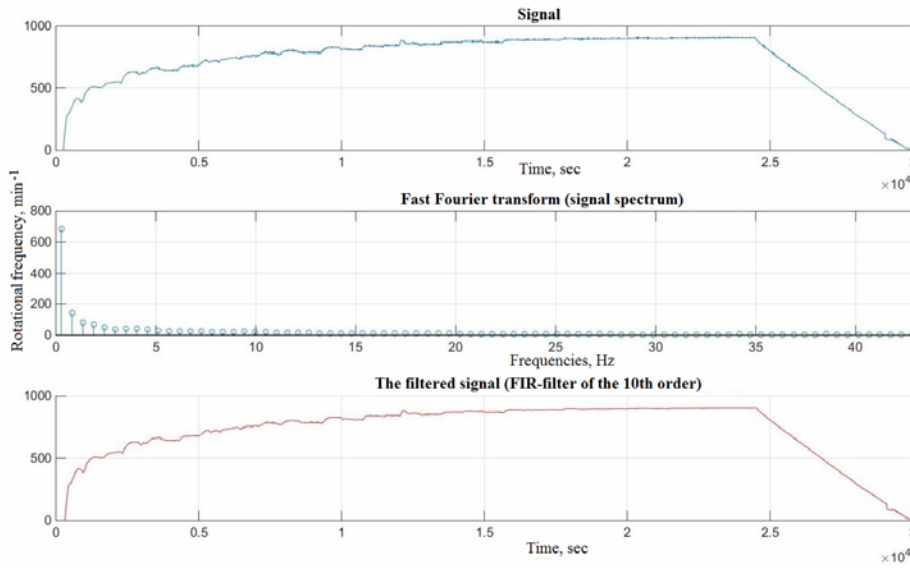

Fig. 4. Interferences obtained during sensor tests

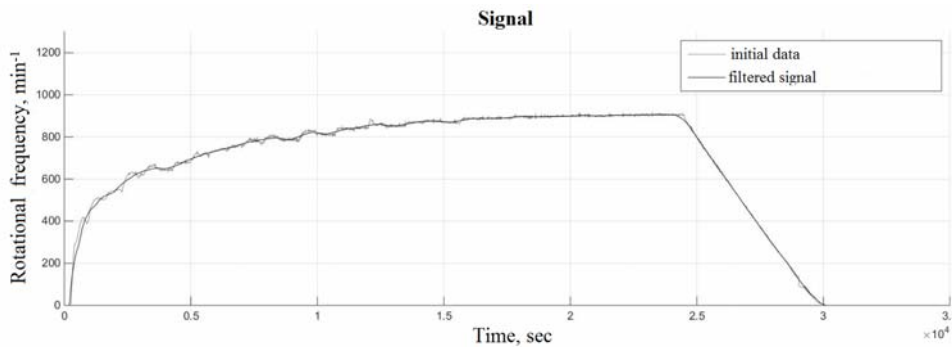

Fig. 5. Filtration of interferences using the moving average algorithm

As a result of studies the errors in the program part of the stand were not found. But a potential source of interference was found in the hardware (electronic) part of the stand.

The pulse driver (which go to the input of the microcontroller) was nothing but a Schmitt trigger CD40106BM [8] manufactured by Texas Instruments. And, as it is known, such triggers have a wide range of thresholds for both operation and release of the logical unit. This effect is shown in Fig. 6 taken from the official documentation.

Since the fronts of the incoming pulses from the sensor are quite heavily overloaded (as it is shown in Fig. 7), the signal at the output of the driver (Schmidt trigger CD40106BM) will always be of unequal duration, taking into account the specificity of its operation shown in Fig. 6.

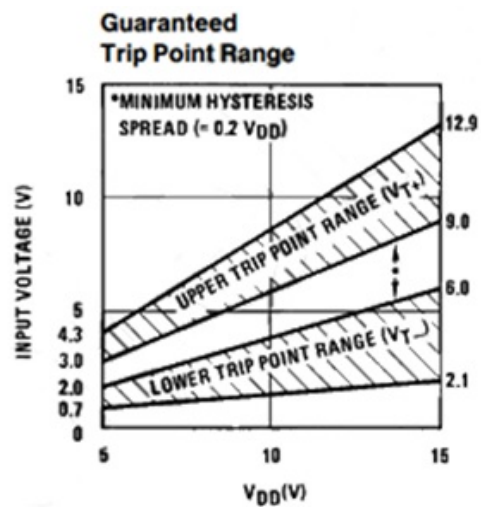

Fig. 6. Range of thresholds for operation and release of the Schmitt trigger CD40106BM [8]

ЕКСПЛУАТАЦІЯ ТА РЕМОНТ ЗАСОБІВ ТРАНСПОРТУ

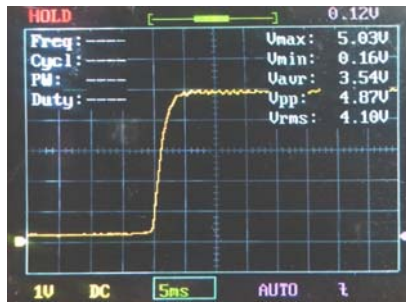

Fig. 7. Oscillogram of the front of the signal coming from the sensor

Analysis of the existing microcircuits of single-pass Schmitt triggers showed that they have similar characteristics, as well as for the Schmitt trigger CD40106BM. The way out of this situation is the use of two-input Schmitt triggers, where it is possible to set a fixed operation voltage due to the use of backward communication. The study of the market of existing microcircuits of two-input Schmitt triggers and operational amplifiers was conducted. As a result, it was found that the use of microcircuits of two-input Schmitt triggers is not rational: the operational amplifier makes it possible to set operating voltage more flexible and accurate with minimal deviations, and its cost does not exceed the cost of the Schmitt trigger. Therefore, it was decided to make own pulse driver using the operational amplifier LM124 [10].

The driver is constructed according to the scheme shown in Fig. 8

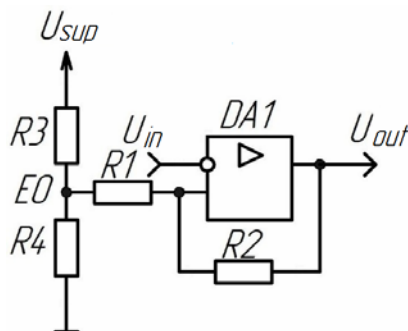

Fig. 8. Scheme of the pulse driver on the operational amplifier

To calculate the driver [3, 7], the following input conditions are accepted:

The supply voltage $U_{sup} = 4.7$ V;

The operate voltage $U_{op} = 3$ V;

The maximal voltage at the output of the amplifier, the received one 1-2 V less than the supply voltage $U_{max} = 3.46$ V;

The minimum voltage at the output of the amplifier is $U_{min} = 0.3$ V.

The driver is constructed according to the scheme in Fig. 8.

To calculate the positive feedback resistor $R2$, it is necessary to determine the hysteresis ΔU of the amplifier. It has been experimentally established that $\Delta U = 0.3$ V is sufficient for stable operation. Resistor $R1$ was selected with a nominal of 39 kOhm. Accordingly, based on the results of calculations, $R2 = 452.4$ kOhm.

To form the bias voltage $E0$ of the operating point of the amplifier switching, it is calculated by the formula:

$$E0 = U_{op} - \frac{\Delta U}{2}.$$

Thus, $E0 = 2.85$ V. Resistor $R4$ was selected with a nominal value of 3.3 kOhm. Correspondingly, according to the results of calculations $R3 = 2142.11$ Ohm.

To check the accuracy of calculations, it is also necessary to calculate the operating and release voltages of the operational amplifier. To do this, the speed of switching a_{sw} , is required, which for the selected amplifier is 0.1 V/ms [3, 7]. The operating voltage $U_{0 \rightarrow 1}$ is calculated by the formula:

$$U_{0 \rightarrow 1} = U_{max} \frac{R1}{R1 + R2} + E0 \frac{R2}{R1 + R2} + a_{sw}.$$

The release voltage $U_{1 \rightarrow 0}$ is calculated by the formula:

$$U_{1 \rightarrow 0} = U_{min} \frac{R1}{R1 + R2} + E0 \frac{R2}{R1 + R2} - a_{sw}$$

According to the results of calculations, $U_{0 \rightarrow 1} = 3$ V, and $U_{1 \rightarrow 0} = 2.55$ V. Simulation of this calculated circuit of the driver confirmed the accuracy of calculations. The oscillograms of the operation simulation are shown in Fig. 9.

Real tests of the new pulse driver were also carried out. The graph of the performed measurements is shown in Fig. 10. As can be seen from Fig. 10 there is practically no interference in the results obtained. This allows us to talk about identifying and complete eliminating the source of data distortion in the developed hydraulic transmission testing system. In this case, the application of digital filtering algorithms is not necessary.

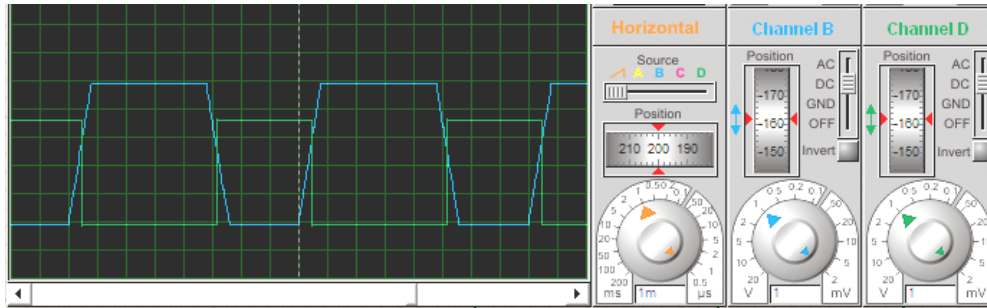

Fig. 9. The oscillograms of the driver operation simulation

Findings

For the projected optical sensor of the rotational frequency based on the existing D-2MMU-2 sensor, the analysis of the methodological and instrumental errors was performed. Based on the data obtained, a more rational variant of the frequency calculation algorithm was proposed, and the num-

ber of teeth of the sensor disk was justified. The nature of the interferences that occur during data collection was investigated. As a result, the main source of measurement distortion was established and the method for improving the hardware of the hydraulic locomotive test bench, which eliminated this source, was proposed.

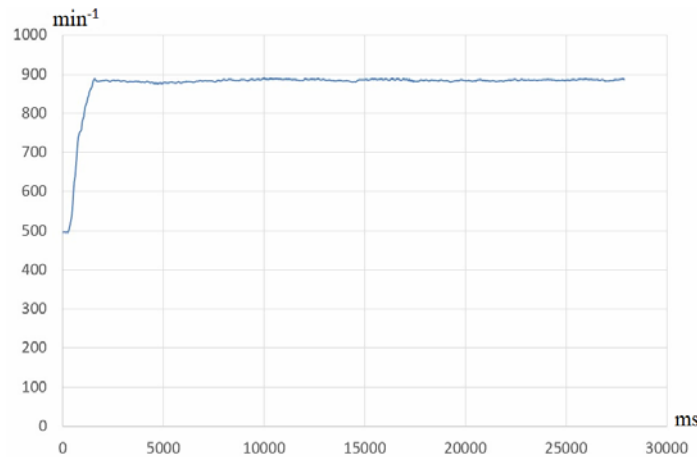

Fig. 10. The graph of the performed measurements of the rotational frequency using the pulse driver based on the operational amplifier

Originality and Practical Value

The studies of the dependence of the methodological and instrumental errors of the designed rotational frequency sensor were conducted. Rational mechanisms for filtering the interferences that occur when fixing the rotational frequency have been proposed. Additional studies have shown the need for hardware refinement of the signal conditioner circuit. The conducted researches allowed establishing a rational number of the sensor disk teeth, which made it possible to improve the measurement algorithm. It was also proposed hardware improvement of the signal conditioner circuit from

the sensor, which made it possible to get rid of interferences. The results of the measurements during the studies are the initial data for further research to determine the technical state of the hydraulic transmission UGP 750-1200 during the factory post-repair tests.

Conclusions

The dependence of the instrumental and methodological errors of the developed tachometric sensor of the optical type was investigated. Based on the studies carried out, it is proposed to modify the algorithm for calculating the rotational frequency as follows: up to 50 min^{-1} (valid at the

ЕКСПЛУАТАЦІЯ ТА РЕМОНТ ЗАСОБІВ ТРАНСПОРТУ

average acceleration $a = 1.15 \text{ min}^{-1}/\text{s}^2$ [13]) to perform calculations taking into account every second period of the signal from the sensor (for 10 teeth disk), and starting from the rotational frequency greater than 50 min^{-1} to take into account the duration of ten periods of the signal from the sensor as one period, i.e. to simulate a disk with one tooth. It

was found that the use of a 10-tooth disc is rational. In order to eliminate distortions in the measurements, calculation and testing of the pulse driver from the sensor based on the operational amplifier LM124 was performed on the basis of the used Schmitt trigger CD40106BM.

LIST OF REFERENCE LINKS

1. Воскобойников, Ю. Е. Фильтрации сигналов и изображений: Фурье и вейвлет алгоритмы (с примерами в Mathcad) : монография / Ю. Е. Воскобойников, А. В. Гочаков, А. Б. Колкер ; Новосиб. гос. архитектур.-строит. ун-т (Сибстрин). – Новосибирск : НГАСУ, 2010. – 188 с.
2. Жуковицький, І. В. Вдосконалення методів та засобів вимірювання частоти обертання вала гідравлічної передачі тепловоза з використанням мікроконтролера / І. В. Жуковицький, І. А. Ключник // Сучасні інформ. та комунік. технології на трансп., в пром-сті та освіті : тез. X Міжнародн. наук.-практ. конф. (14.12–15.12.2016 г.) / Днепропетр. нац. ун-т ж.-д. трансп. – Днепропетровск, 2016. – С. 46–47.
3. Мамий, А. Р. Операционные усилители / А. Р. Мамий, В. Б. Тлячев. – Майкоп : АГУ, 2005. – 192 с.
4. Рабинович, С. Г. Погрешности измерений : науч. изд. / С. Г. Рабинович. – Ленинград : Энергия, 1978. – 261 с.
5. Сергиенко, А. Б. Цифровая обработка сигналов : учеб. пособие / А. Б. Сергиенко. – 2-е изд. – Санкт-Петербург : Питер, 2007. – 750 с.
6. Тахометры магнитоиндукционные дистанционные ТМи [Electronic resource] // ООО «Саранские приборы». – 2016. – Available at: <http://sibspz.ru/pribory-dlya-izmereniya-parametrov-dvizheniya-takhometry/takhometry-magnitoinduksionnye-distantsionnye-tmi>. – Title from the screen. – Accessed : 28.12.2016.
7. Carter, B. Op Amps for Everyone / B. Carter. – 2nd ed. – Texas, USA : Elsevier Science, 2003. – 472 с.
8. CD40106BM/CD40106BC. Hex Schmitt Trigger [Electronic resource] // Texas Instruments. – 2016. – Available at: <http://www.ti.com/lit/ds/symlink/cd40106bm.pdf>. – Title from the screen. – Accessed : 28.12.2016.
9. Information-measuring Test System of Diesel Locomotive Hydraulic Transmissions / I. V. Zhukovytsky, I. A. Kliushnyk, O. B. Ochkasov, R. O. Korenyuk // Наука та прогрес транспорту. – 2015. – № 5 (59). – С. 53–65. doi: 10.15802/stp2015/53159.
10. LMx24-N, LM2902-N. Low-Power, Quad-Operational Amplifiers [Electronic resource] // Texas Instruments. – 2016. – Available at: <http://www.ti.com/lit/ds/symlink/lm2902-n.pdf>. – Title from the screen. – Accessed : 28.12.2016.
11. Merry, R. J. E. Optimal higher-order encoder time-stamping / R. J. E. Merry, M. J. G. van de Molengraft, M. Steinbuch // Mechatronics. – 2013. – Vol. 23. – Iss. 5. – P. 481–490. doi: 10.1016/j.mechatronics.2012.10.011.
12. Zhang, L. An open embedded hardware and software architecture applied to industrial robot control / L. Zhang, P. Slaets, H. Bruyninckx // IEEE Intern. Conf. on Mechatronics and Automation. – 2012. – P. 1822–1828. doi: 10.1109/ICMA.2012.6285098.
13. Zhukovytsky, I. V. Use of microcontroller for measuring shaft speed of diesel locomotive hydraulic transmission / I. V. Zhukovytsky, I. A. Kliushnyk // Наука та прогрес транспорту. – 2016. – № 5 (65). – С. 43–53. doi: 10.15802/stp2016/83990.

І. В. ЖУКОВИЦЬКИЙ^{1*}, І. А. КЛЮШНИК^{2*}

^{1*}Каф. «Електронні обчислювальні машини», Дніпропетровський національний університет залізничного транспорту імені академіка В. Лазаряна, вул. Лазаряна, 2, Дніпро, Україна, 49010, тел. +38 (056) 373 15 89, ел. пошта ivzhuk@mail.ru, ORCID 0000-0002-3491-5976

^{2*}Каф. «Електронні обчислювальні машини», Дніпропетровський національний університет залізничного транспорту імені академіка В. Лазаряна, вул. Лазаряна, 2, Дніпро, Україна, 49010, тел. +38 (056) 373 15 89, ел. пошта klugran@i.ua, ORCID 0000-0001-9939-0755

ВИБІР ОПТИМАЛЬНИХ ПАРАМЕТРІВ ВИМІРЮВАННЯ ЧАСТОТИ ОБЕРТАННЯ ВАЛА ГІДРАВЛІЧНОЇ ПЕРЕДАЧІ ТЕПЛОВОЗА З ВИКОРИСТАННЯМ МІКРОКОНТРОЛЛЕРА

Мета. Стаття передбачає знаходження рішення задачі розробки та удосконалення засобів вимірювання тахометричних даних раніше створеної інформаційно-вимірювальної системи випробувань гідравлічних передач тепловозів шляхом обґрунтування оптимальної конструкції датчика та алгоритмів обробки сигналу від нього. При цьому відштовхуватися необхідно, в першу чергу, від можливості модифікації вже існуючого стенду випробувань гідравлічних передач тепловозів на Дніпропетровському заводі по ремонту тепловозів «Промтепловоз». **Методика.** У роботі дослідниками була запропонована методика модифікації конструкції датчика оптичного типу на основі датчика Д-2ММУ-2 мікропроцесорної автоматизованої системи стендових випробувань гідравлічних передач тепловозів в умовах тепловозоремонтного заводу. Обґрунтовано вибір необхідного алгоритму вимірювань і кількості зубців датчика шляхом розрахунків інструментальної та методичної похибок. Також описані дослідження, спрямовані на виявлення джерела перешкод при вимірах частоти обертання та знайдено рішення щодо його усунення. **Результати.** Для спроектованого датчика частоти обертання оптичного типу на основі вже існуючого датчика Д-2ММУ-2 авторами було виконано аналіз залежності методичної та інструментальної похибок. Запропоновано, на основі отриманих даних, більш раціональний варіант алгоритму розрахунку частоти обертання, а також обґрунтована кількість зубців диска датчика. Далі було встановлено основне джерело перешкод вимірів та був запропонований спосіб удосконалення апаратної частини стенду випробувань гідравлічних передач тепловозів. **Наукова новизна.** Були проведені дослідження залежності методичної та інструментальної похибок спроектованого датчика частоти обертання. Запропоновані механізми фільтрації перешкод, що виникають при фіксації частоти обертання датчиком. Додаткові дослідження показали необхідність апаратного доопрацювання схеми формувача сигналу. **Практична значимість.** Проведені дослідження дозволили встановити раціональну кількість зубців диска датчика, що дало можливість удосконалити алгоритм вимірювань. Також було виконано апаратне поліпшення схеми формувача сигналу від датчика, що дозволило позбутися перешкод. Результати вимірювань при дослідженні є вихідними даними для виконання подальших досліджень із метою визначення технічного стану гідравлічної передачі УГП 750-1200 під час заводських післяремонтних випробувань.

Ключові слова: тахометричний датчик; Д-2ММУ-2; гідравлічна передача; випробування гідропередач; випробувальний стенд; інформаційно-вимірювальна система

И. В. ЖУКОВИЦКИЙ^{1*}, И. А. КЛЮШНИК^{2*}

^{1*}Каф. «Электронные вычислительные машины», Днепропетровский национальный университет железнодорожного транспорта имени академика В. Лазаряна, ул. Лазаряна, 2, Днепро, Украина, 49010, тел. +38 (056) 373 15 89, эл. почта ivzhuk@mail.ru, ORCID 0000-0002-3491-5976

^{2*}Каф. «Электронные вычислительные машины», Днепропетровский национальный университет железнодорожного транспорта имени академика В. Лазаряна, ул. Лазаряна, 2, Днепро, Украина, 49010, тел. +38 (056) 373 15 89, эл. почта klugran@i.ua, ORCID 0000-0001-9939-0755

ВЫБОР ОПТИМАЛЬНЫХ ПАРАМЕТРОВ ИЗМЕРЕНИЯ ЧАСТОТЫ ВРАЩЕНИЯ ВАЛА ГИДРАВЛИЧЕСКОЙ ПЕРЕДАЧИ ТЕПЛОВОЗА С ИСПОЛЬЗОВАНИЕМ МИКРОКОНТРОЛЛЕРА

Цель. Статья предусматривает нахождение решения задачи разработки и усовершенствования средств измерения тахометрических данных ранее созданной информационно-измерительной системы испытаний гидравлических передач тепловозов путем обоснования оптимальной конструкции датчика и алгоритмов обработки сигнала от него. При этом отталкиваться необходимо, в первую очередь, от возможности модификации уже существующего стенда испытаний гидравлических передач тепловозов на Днепропетровском заводе по ремонту тепловозов «Промтепловоз». **Методика.** В работе исследователями была предложена методика модификации конструкции датчика и алгоритма обработки его сигналов. Она опирается на предыдущие разработки тахометрического датчика оптического типа на основе датчика Д-2ММУ-2 микропроцес-

ЕКСПЛУАТАЦІЯ ТА РЕМОНТ ЗАСОБІВ ТРАНСПОРТУ

сорной автоматизированной системы стендовых испытаний гидравлических передач тепловозов в условиях тепловозоремонтного завода. Обоснован выбор необходимого алгоритма измерений и количества зубьев датчика путем расчетов инструментальной и методической погрешностей. Также описаны исследования, направленные на выявление источника помех при измерениях частоты вращения, и найдено решение по его устранению. **Результаты.** Для спроектированного датчика частоты вращения оптического типа на основе уже существующего датчика Д-2ММУ-2 авторами был выполнен анализ зависимости методической и инструментальной погрешностей. Предложен, на основе полученных данных, более рациональный вариант алгоритма расчёта частоты вращения, а также обосновано количество зубьев диска датчика. Далее был установлен основной источник помех измерений и был предложен способ усовершенствования аппаратной части стенда испытаний гидравлических передач тепловозов. **Научная новизна.** Были проведены исследования зависимости методической и инструментальной погрешностей спроектированного датчика частоты вращения. Предложены механизмы фильтрации помех, возникающих при фиксации частоты вращения датчиком. Дополнительные исследования показали необходимость аппаратной доработки схемы формирователя сигнала. **Практическая значимость.** Проведённые исследования позволили установить рациональное количество зубьев диска датчика, что дало возможность усовершенствовать алгоритм измерений. Также было выполнено аппаратное улучшение схемы формирователя сигнала от датчика, что позволило избавиться от помех. Результаты измерений при исследованиях являются исходными данными для выполнения дальнейших исследований с целью определения технического состояния гидравлической передачи УГП 750-1200 во время заводских послеремонтных испытаний.

Ключевые слова: тахометрический датчик; Д-2ММУ-2; гидравлическая передача; испытания гидропередач; испытательный стенд; информационно-измерительная система

REFERENCES

1. Voskoboynikov, Y. Y., Gochakov, A. V., & Kolker, A. B. (2010). *Filratsii signalov i izobrazheniy: Fure i veyvlet algoritmy (s primerami v Mathcad)*. Novosibirsk: NSUACE.
2. Zhukovytskyi, I. V., & Kliushnyk, I. A. (2016). Vdoskonalennia metodiv ta zasobiv vymiriuvannia chastoty obertannia vala hidravlichnoi peredachi teplovoza z vykorystanniam mikrokontrolera. *Proceedings of the X International Conference «Modern Information and Communication Technologies on a Transport, in Industry and Education», Dec. 14-15, 2016, Dnipro, Ukraine*. 46-47.
3. Mamiy, A. R., & Tlyachev, V. B. (2005). *Operatsionnyye usiliteli*. Maikop: ASU.
4. Rabinovich, S. G. (1978). *Pogreshnosti izmereniy*. Leningrad: Energiya.
5. Sergienko, A. B. (2007). *Tsifrovaya obrabotka signalov* (2nd ed.). St. Petersburg: Piter.
6. *Takhometry magnitoinduksionnyye distantsionnyye TMI*. (n.d.) Retrieved from <http://sibspz.ru/pribory-dlya-izmereniya-parametrov-dvizheniya-takhometry/takhometry-magnitoinduksionnyye-distantsionnyye-tmi>
7. Carter, B. (2003). *Op Amps for Everyone* (2nd ed.). Texas, USA: Elsevier Science.
8. *CD40106BM/CD40106BC. Hex Schmitt Trigger*. (2011). Dallas, Texas: Texas Instruments Incorporated. Literature Number: SNOS353B. Retrieved from <http://www.ti.com/lit/ds/symlink/cd40106bm.pdf>
9. Zhukovytskyi, I. V., Kliushnyk, I. A., Ochkasov, O. B., & Korenyuk, R. O. (2015). Information-Measuring Test System of Diesel Locomotive Hydraulic Transmissions. *Science and Transport Progress*, 5(59), 53-65. doi: 10.15802/stp2015/53159
10. *LMx24-N, LM2902-N. Low-Power, Quad-Operational Amplifiers*. (2016). Dallas, Texas: Texas Instruments Incorporated. Retrieved from <http://www.ti.com/lit/ds/symlink/lm2902-n.pdf>
11. Merry, R. J. E., Van de Molengraft, M. J. G., & Steinbuch, M. (2013). Optimal higher-order encoder time-stamping. *Mechatronics*, 23(5), 481-490. doi: 10.1016/j.mechatronics.2012.10.011
12. Zhang, L., Slaets, P., & Bruyninckx, H. (2012). An open embedded hardware and software architecture applied to industrial robot control. *Proceedings of the IEEE International Conference on Mechatronics and Automation, Aug. 5-8, 2012*. 1822-1828. doi: 10.1109/ICMA.2012.6285098
13. Zhukovytskyi, I. V., & Kliushnyk, I. A. (2016). Use of microcontroller for measuring shaft speed of diesel locomotive hydraulic transmission. *Science and Transport Progress*, 5(65), 43-53. doi 10.15802/stp2016/83990

Prof. V. V. Skalozub, D. Sc. (Tech.), (Ukraine); Prof. V. V. Tkachov, D. Sc. (Tech.), (Ukraine) recommended this article to be published

Accessed: Oct. 19, 2016

Received: Feb. 22, 2017