

# THE SERVICE LIFE EVALUATION OF FERTILIZER SPREADERS UNDERCARRIAGES

/

Prof.Dr.Sc.Eng. Popovych P.V.<sup>1)</sup>, Prof. Dr.Sc. Eng. Lyashuk O.L.<sup>1)</sup>, Lect. Ph.D. Eng. Murovanyi I.S.<sup>2)</sup>,  
Lect. Ph.D. Eng.Dzyura V.O.<sup>2)</sup>, Lect. Ph.D. Eng. Shevchuk O.S.<sup>2)</sup>, Lect. Ph.D. Eng. Myndyuk V.D.<sup>3)</sup>

<sup>1)</sup>Ternopil Ivan Pul'uj National Technical University, Ternopil / Ukraine

<sup>2)</sup>Lutsk National Technical University, Lutsk / Ukraine

<sup>3)</sup>Ivano-Frankivsk National Technical University of Oil and Gas, Ivano-Frankivsk / Ukraine

E-mail: [volodymyrdzyura@gmail.com](mailto:volodymyrdzyura@gmail.com)

**Keywords :** *spreader, mineral fertilizers, organic fertilizers, aggressive environment, crack, stress*

## ABSTRACT

The analytical models to determine the residual service life of metal undercarriages of open profile fertilizer spreaders at exposure in organic and mineral fertilizers environments are developed. The service life of rail elements is considered as the sum of periods of formation and subcritical growth of fatigue cracks. The formulae for determining stress intensity factors near existing cracks are developed, as well as the formulae for determining the service life of “Z” cross section and “ ” cross section. The kinetic equations for determining the formation and distribution periods are deduced. When examining the calculations, it was found that mineral fertilizers in comparison with organic ones greatly reduce the service life of elements under study.

Z-

## INTRODUCTION

Some aggressive agricultural environments, in particular fertilizers, acting as an additional fatigue factor, significantly reducing the resistance to cracks formation (Gaydar S. ., 2011; Severnev . . et al, 2011). Some of the well-known theoretical approaches to reducing the phase of cracks formation are substantiated by electrochemical heterogeneity of the material in active slip planes. This fact causes the formation of pittings, which can be considered as the initial defects and additional stress concentrators (Fig.1).



**Fig. 1 – Corrosion-fatigue damages of fertilizer spreaders metal structures after two seasons of operation**

Other approaches associate the acceleration of cracks formation with the weakening of protective films on the metal surface (Yarema S.Y., 1973; Panasiuk V.V. et al, 1988; Romaniv .N. et al, 1990; Troshchenko V. ., 1981; Cherepanov G.P., 1974; Schijve J., 2003; Andreykiv . ., Darchuk .I., 1992). It is well known that these films are formed due to exposure of a specimen in aggressive corrosive environment and are destroyed by slip lines. During this process, in the destruction area of a film, a

galvanic couple originates with a small anode zone and with a large cathode zone, which is a solid oxide layer on a specimen surface. Thus, the process of local metal solution accelerates in slip bands, and the cracks formation period  $N$  is significantly shortened. This type of destruction is characteristic for metal structures elements of fertilizer spreaders because of joint influence of dynamic load and aqueous solutions of mineral or organic fertilizers. In most cases, the main carriage components of agricultural machinery metal structures under study are thin rod components.

## MATERIAL AND METHOD

The known deformation-minimizing method of rod systems was applied to define the stress-strained state of a trailing fertilizer RTD-9. The energy of bending deformation and torsion that greatly influences the undercarriage was considered. All stated above is proved by correlation with experimental data. To perform the calculations, the values of internal power factors were developed. Based on these factors, the stress-strained state in the most loaded sections of metal structures was defined (Table 1).

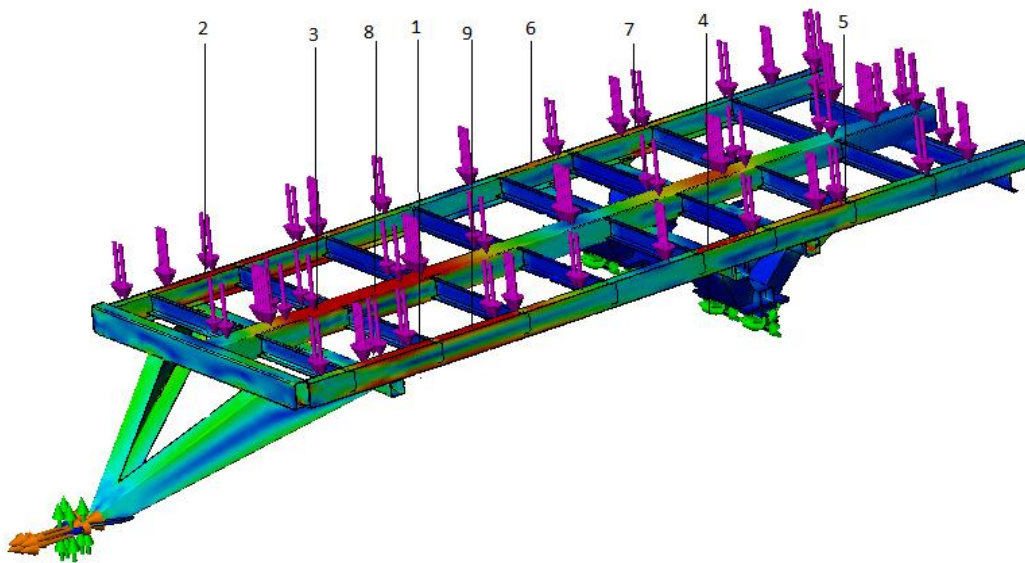

Fig. 2 – Sections of the undercarriage of organic fertilizer spreader RTD - 9 with maximum stresses

Table 1

Stresses in the most dangerous sections of the undercarriage of solid organic fertilizer spreaders RTD -9

section	The values of normal stresses, MPa
1.	160 MPa ("Z" cold-bent section 200×60×5, GOST 13229-78).
2.	152 MPa ("Z" cold-bent section 200×60×5, GOST 13229-78).
3.	188 MPa (two "Z" cold-bent welded sections 200×60×5)
4.	66 ("Z" cold-bent section 200×60×5, GOST 13229-78).
5.	126 ("Z" cold-bent section 200×60×5, GOST 13229-78).
6.	68 ("Z" cold-bent section 200×60×5, GOST 13229-78).
7.	105 ("Z" cold-bent section 200×60×5, GOST 13229-78).
8.	99 (two "Z" cold-bent welded sections 200×60×5)
9.	152 ("Z" cold-bent section 200×60×5, GOST 13229-78).

In all calculations, the solution of mixed organic fertilizer acts as the corrosive working environment. It is a solution of mixed cattle manure and pig manure (1/2+1/2) and a saturated solution of nitrophosphate.

Further calculations should be performed for the most loaded elements of section 1 (longeron – "Z" cold-bent section 200×60×5, normal stresses in cross-section 160 MPa); section 3 ("Ω" section - two "Z" cold-bent welded sections 200×60×5, the normal stress in intersection 188 MPa, geometric characteristics of profiles) (Pisarenko G.S., Yakovlev .P., Matveev V.V., 1988).

Residual service life of a metal structure is defined by the durability of its most loaded elements. According to the modern theory of delayed fracture mechanics of structural elements, the service life of a structural element  $N_p$  with variable loads (Yarema S.Y., 1973; Andreikiv O.E., Kit M.B., Khyh' S.V. 2013; Romaniv .N. et al., 1990; Troshchenko V. ., 1981; Cherepanov G.P., 1974; Schijve J., 2003; Andreykiv . ., Darchuk .I., 1992). is defined:

$$N = N + N \quad (1)$$

where  $N$  - period of formation of fatigue cracks;  $N$  - period of subcritical growth of fatigue cracks.

The period of formation of a fatigue crack  $N$ , in the element of structure with the external loading of amplitude  $\dagger_0$  in variable in time stresses (Romaniv .N. et al, 1990) is presented as follows:

$$N = N_0 10^{-\sigma/\sigma_0} \quad (2)$$

Thus, to determine  $N = N$  of corrosion macro-crack formation in the element under study, it is necessary to specify experimentally the characteristics of an area of fatigue curve finite life  $\dagger_0, N_0$  (Romaniv .N. et al., 1990). Methods of testing results under the influence of aggressive environments are presented in. Specified characteristics of metal structure materials of fertilizer spreaders are analyzed in the same work.

Based on the results, the definition  $N = N$  of subcritical growth of a corrosion - fatigue crack is depicted by the following mathematical problem:

$$V = V_c, \quad K_{sc} < K_{I \max} \leq K_{II}; \quad (3)$$

$$\frac{dl}{dN} = S_1 (1-R)^4 (K_{I \max}^4 - K_{th \max}^4) (K_{fC}^2 - K_{I \max}^2)^{-1}, \quad K_{II} < K_{I \max} < K_{fC},$$

with the given initial and final conditions

$$N = 0, l(0) = l_0; \quad N = N, l(N) = l_*, \quad K_I(l_*) = K_{fC} \quad (4)$$

where:

$K_{I \max}$  - maximum stress intensity factor (SIF) for the cycle;

$K_{fC}, K_{th \max}$  - correspondingly, the upper and lower SIF threshold values in the kinetic diagrams of propagating fatigue and corrosion mechanical cracks,  $MPa \cdot m^{1/2}$ ;

$R = K_{I \min} / K_{I \max}$  - loading cycle asymmetry;

$V_c$  - constant speed value of near-threshold corrosion-fatigue crack propagation to the intersection with a diagram of fatigue crack propagation with a stress intensity factor  $K_{I \max} = K_{II}$ ;

$S_1$  - corrosion fatigue characteristic features of the material that are defined experimentally.

Based on experimentally developed  $V_c, S_1, K_{fC}, K_{th \max}, K_{II}$ , the period  $N = N$  of subcritical growth of a corrosion-fatigue crack in the element under study is defined by means of calculation (3) and (4).

In metal structures of agricultural machinery frames, thin rod elements are commonly used. For these elements, the stress due to bending deformation is defined according to (Pisarenko G.S. et al., 1988).

$$\dagger = MW_x^{-1} \quad (5)$$

where  $M$  - value of the bending moment,  $W_x$  - section modulus.

In undercarriages of fertilizer spreaders, the rail elements of open and closed profiles are commonly used: channels, "Z" profiles and " " profiles. Service life of maximum loaded elements determines the service life of a metal structure in general. Thus, the service life of the given elements is determined by the formula (1), where the period of corrosion-fatigue crack formation is determined according to Weller curve (2). Determination of subcritical growth period  $N$  associates with some mathematical difficulties. For this reason, in this paper, the research is devoted to the determination of

periods of subcritical growth of corrosion-fatigue cracks in rails of the given profiles due to bending loads.

The open profile rail elements weakened by a straight surface crack of a length  $l_0$  under the action of cyclic bending load are analysed. It is necessary to determine the period of subcritical crack growth (remaining life)  $N = N$ . Definition of the period of subcritical growth of a fatigue crack is the number of cycles of loading the structure element. Finally, the crack grows to a size  $l = l_*$ . Thus, the further operation of a construction is possible only after the debugging. The problem is solved by relations (3) and (4). The most complex task is to determine the SIF of a kinetic equation (3). When determining the stress intensity factor,  $K_I$ , a thin-walled metal element of a metal structure with a surface crack of a length  $l$  is assumed to be loaded in such a way that its stress-strain state is relatively symmetrical to the line of crack placement. Therefore, when determining the value  $K_I$ , a half-plane with a surface crack (Andreikiv O.E., Dolins'ka I.Y., Kukhar V.Z., 2013) is considered as one of the limiting states.

$$K_I = 1.12 \dagger \sqrt{f \cdot l} \quad (6)$$

$\dagger$  - nominal normal stress,  $P$  ;

Based on the above, SIF of a crack is defined by the formula

$$K_I = \dagger \sqrt{f \cdot l} (1.12 + F(v)) \quad (7)$$

where  $v = l/D$ ;  $D$  - the maximum size of a cross section of the structure element under study behind the line of crack placement;  $\dagger$  – nominal tension at the crack top;  $F(v)$  – dimensionless function, if  $v \rightarrow 0$   $F(v) \rightarrow 0$ . In each given case, the function  $F(v)$  is defined according to the specific features of the structural cracked element.

The rail of “Z” cross section is loaded with the bending moment  $M$  (Fig.3).

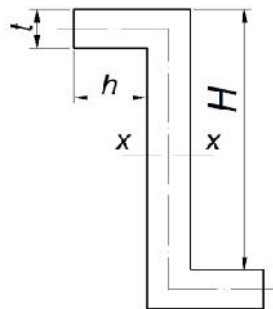

Fig.3 – “Z” profile cracked rail

To implement the mathematical models (3) and (4), it is necessary to account analytically the SIF as a stress function and section modulus  $W_x$ . The section modulus is determined (Pisarenko G.S. et al., 1988)

$$W_x = (6H)^{-1} [hH^3 - (h-t)(H-2t)^3] \quad (8)$$

## RESULTS

To account the SIF, two cases were investigated. The first case: a crack length  $l$  is short as compared to the outline cross-sectional dimensions. Thus, the state of stress near the crack top is equivalent to stresses  $\sigma_{\max}$  that occur during the tensile of a half-infinite plate with an edge crack (Panasyuk V.V., 1988) (6). The second case: the contour of the crack is in a zone close to the neutral axis of a cross section. To determine the SIF, the problem solution of the bending moment  $M$  of a band with an edge crack is applied (Panasyuk V.V., 1988). The unknown function was assumed as  $F_1(v_1)$  in the form of polynomial coefficients that maximum approximate the correlations for the SIF. Thus, in these two limiting cases, the dependence for SIF  $K_I$  is developed:

$$K_I = \dagger \sqrt{2h+H} \sqrt{fv_1} [1.12 + F_1(v_1)] \quad (9)$$

$$F_1(v_1) = 0.52\sqrt{v_1}(1 + 6.42v_1^2 - 6.53v_1^3 + 5.86v_1^4), \quad v_1 = l(2h + H)^{-1}$$

After substitution (9) into (3) and integration within the initial and final conditions (4), in order to determine the period of subcritical crack growth  $N = N^{(1)}$  the following formulae are deduced:

$$N^{(1)} = \frac{l_i - l_0}{V_c} + \frac{K_{fc}^2(H + 2h)}{S_1 K_{th}^4(1 - R)^4} \int_{v_i}^{v_*} \frac{1 - f_1(v)}{f_2(v) - 1} dv, \quad v_* = \frac{l_*}{2h + H}, v_i = \frac{l_i}{2h + H} \tag{10}$$

$$f_1(v) = \frac{f \dagger^2 v (2h + H)}{K_{fc}^2} [1.12 + F_1(v)]^2, \quad f_2(v) = \frac{f^2 \dagger^4 v^2 (2h + H)^2}{K_{th}^4} [1.12 + F_1(v)]^4$$

The resulting formula (1), (2), (10) enable to account the service life of the rail  $N_p$

$$N_p = N_0 10^{-\dagger/\dagger_0} + \frac{l_i - l_0}{V_c} + \frac{K_{fc}^2(H + 2h)}{S_1 K_{th}^4(1 - R)^4} \int_{v_i}^{v_*} \frac{1 - f_1(v)}{f_2(v) - 1} dv \tag{11}$$

Characteristic features of the material  $N_0, \dagger_0, V_c, K_{th}, K_{fc}, K_{th}, S_1$  are under experimental study. In eq. (11), a component  $l_0$  is the value of a small order depending on a size of the material structural parameter (Savruk .P., 1988).

To consider an incipient crack as a macroscopic one and to apply rightfully the formula (11), it is more efficient to assume the value  $l_0$  of at least two millimeters. In this case, the calculated value  $N_p$  will be reduced and the error will increase the service life.

The study (service life calculation  $N = N_p$ ) of the structure element of undercarriage (“Z” cross-section  $200 \times 60 \times 5$ , is St 37-3) is carried out according to the formula (11). The element is cyclically loaded by the moment  $M$  (Fig.3) in the previously mentioned working environments. Based on the analysis of kinetic diagrams of fatigue (Schijve J., 2003), mechanical and fatigue properties of St 37-3 should be described as follows (Fig. 4-6):

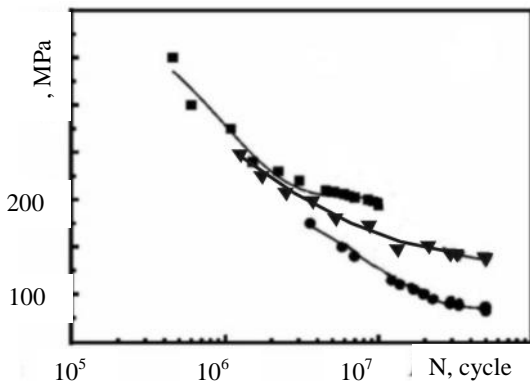

Fig. 4 – Weller curves for St 37-3 are squares; in a fertilizer solution of nitro-phosphate – circles; in mixed organic fertilizer - triangles

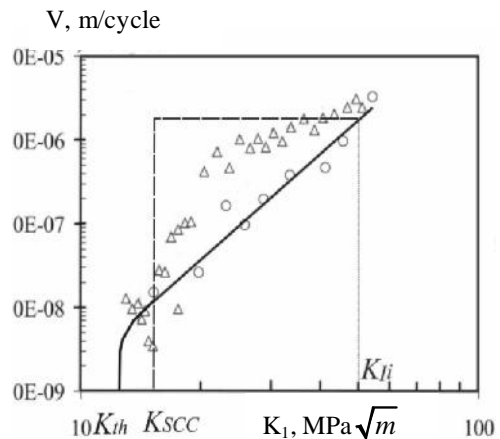

Fig. 5 – Kinetic diagrams of fatigue cracks propagation in St 37-3 in air–circles, at exposure in a mineral fertilizer solution of nitro-phosphate - triangles

- testing in air

$$N_0 = 1.51 \cdot 10^8 \text{ cycle}, \quad S_1 = 4.51 \cdot 10^{-9} (\text{cycle})^{-1} (P)^{-2}, \quad K_{fc} = 102 \quad P \sqrt{m}, \tag{12}$$

$$\dagger_0 = 120,18 \quad P, \quad K_m = 12,81 \quad P \sqrt{m}, \quad R = 0,1;$$

- testing in a fertilizer solution of nitrophosphate

$$\begin{aligned} \dagger_0 &= 95.63 \quad P, \quad N_0 = 2.34 \cdot 10^8 \text{ cycle}, \quad K_{II} = 50 \quad P \sqrt{m}, \\ V_c &= 2,32 \cdot 10^{-6} \text{ m/cycle}; \end{aligned} \tag{13}$$

- testing in mixed manure

$$\begin{aligned} \dagger_0 &= 121.56 \quad P, \quad N_0 = 1.44 \cdot 10^8 \text{ cycle} \quad S_1 = 4.81 \cdot 10^{-9} (\text{cycle})^{-1} (P)^{-2}, \quad l_i = l_0, \\ V_c &\approx 0, \quad K_{II} = 11.21 \quad P \sqrt{m}, \quad R = 0.1, \quad K_{fC} = 101 \quad P \sqrt{m} \end{aligned} \tag{14}$$

Based on (12) - (14), the formula (11) is deduced for all cases of loading in environments.

$$N_p^{(K)} = 1.51 \cdot 10^{8-\dagger/120.18} + 4.18 \cdot 10^7 \int_{0.00625}^{v_*} \frac{1-f_1(v)}{f_2(v)-1} dv \tag{15}$$

- nitro-phosphate solution

$$\begin{aligned} N_p^{(K)} &= 2.34 \cdot 10^{8-\dagger/95.63} + 4.31 \cdot 10^5 (558.43\dagger^{-2} - 0.002) + 4.18 \cdot 10^7 \int_{v_i}^{v_*} \frac{1-f_1(v)}{f_2(v)-1} dv, \\ v_i &= 1745.09\dagger^{-2}, \quad v_* = 5513.66\dagger^{-2}. \end{aligned} \tag{16}$$

- mixed organic fertilizer

$$N_p^{(T)} = 1.44 \cdot 10^{8-\dagger/121.56} + 6.5 \cdot 10^7 \int_{0.00625}^{v_*} \frac{1-f_3(v)}{f_4(v)-1} dv, \tag{17}$$

$$f_1(v) = 9.66 \cdot 10^{-5} \dagger^2 v [1.12 + F_1(v)]^2, \quad f_2(v) = 3.75 \cdot 10^{-5} \dagger^4 v^2 [1.12 + F_1(v)]^4,$$

$$f_3(v) = 9.86 \cdot 10^{-5} \dagger^2 v [1.12 + F_1(v)]^2, \quad f_4(v) = 6.40 \cdot 10^{-5} \dagger^4 v^2 [1.12 + F_1(v)]^4$$

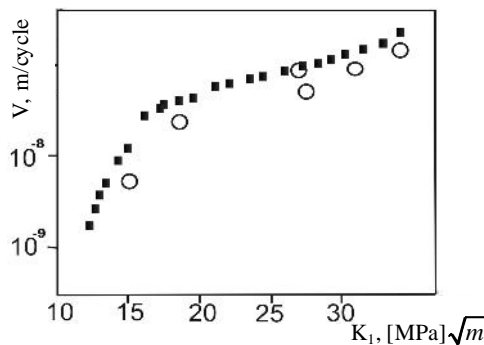

Fig. 6 – Kinetic diagrams of fatigue cracks propagation In St 37-3 in air – circles, at exposure in a solution of mixed organic fertilizers–squares

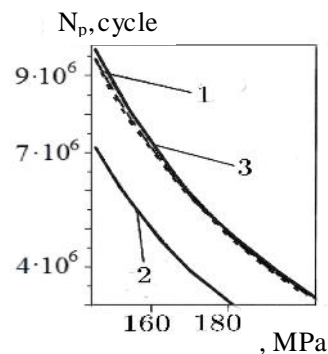

Fig. 7. – Graphic dependence of service life  $N = N_p$  of “Z” profile rail on stresses  $\dagger$  curve : 1 - air; 2–nitro-phosphate solution; 3 (dashes)– mixed manure

The value  $l_i$  in formulae (11), (16) is deduced from  $K_I(v_i) = K_{II}$ ,  $l_i = (H + 2h)v_i$  and determined, approximately, for the given case,  $l_i \approx 558.43\dagger^{-2}$ .

Based on (15), (16) and (17), the graphical dependences of service life  $N = N_p$  of “Z” profile rail as a stress function  $\dagger$  are developed (Fig.5). Corrosive environment significantly reduces the metal structure service life.

The study of a metal undercarriage element of “Ω” cross section (Fig.8). The given rails are commonly used in frame constructions of tractor-trailers and fertilizer spreaders. The case of loading by a cyclical bending moment  $M$  is considered in the mentioned corrosive environments. The challenge is to determine the service life  $N_p$ , that is, to determine the necessary number of loading cycles that cause the formation and symmetrical intersection of two corrosive fatigue cracks on the bottom part of the element. The component  $N$  is defined according to (2),  $N$  - during the solving of mathematical problems (3), (4).



To implement the mathematical model (3), (4), the stress intensity factor as a stress function and  $W_x$  should be analytically accounted. The section modulus due to bending  $W_x$  (Pisarenko G.S., et al, 1988)

$$W_x = 2(6H)^{-1}[hH^3 - (h-t)(H-2t)^3] \tag{18}$$

The stress intensity factor is determined by means of  $\sigma$  and based on (9), where the value  $\dagger$  is defined by means of correlations (5) and (18). It stands to reason that, the service life  $N_p$  of the given rail element is determined according to (11) and with consideration of data (12)-(14). Based on the above mentioned, the equations (15)-(16) should be developed. Their solution is shown in Fig.7. As Fig.5 shows, the service life  $N_p$  of rail elements at the given loads is significant. Nevertheless, their residual service life  $N$ , if the crack of initial length  $l_0$  is available, could be relatively shorten. Thus, the service life of a spreader framework largely depends on the value  $l_0$ . Therefore, the determination of residual service life of cracked rail elements is of great importance. The residual service life of the ‘ $\Omega$ ’ cross section element with two symmetrical cracks on the parts (Fig.6) is  $N$ . The cross section  $200 \times 60 \times 5$ , St 37-3 under bending by the moment  $M$  (Fig.6) and maximum stresses of amplitude  $\dagger = 188 P$  are analyzed when loaded in air, in a solution of nitro-phosphate, and at exposure in mixed organic manure.

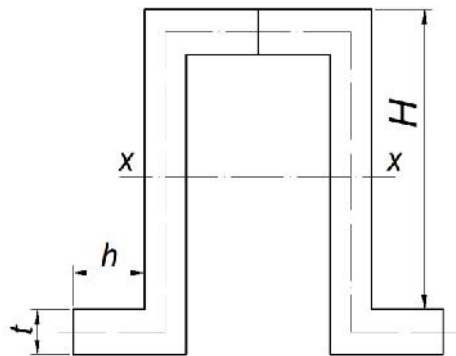

Fig 8 – “ $\Omega$ ” cross section cracked rail

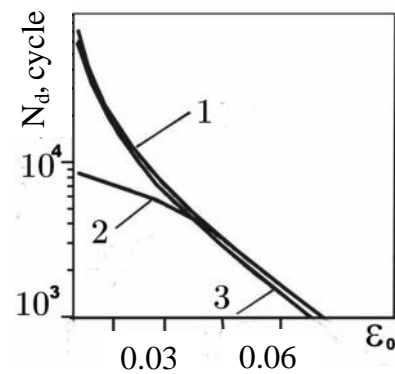

Fig 9 – Service life of “ $\Omega$ ” cross section rail  
1 - air; 2-nitro-phosphate solution; 3 – mixed organic manure

Solution is based on the implementation of the mathematical model (3), (4) taking into account the relations (12) - (14). As a result, to determine the residual life  $N$ , the following formulae are deduced

- air

$$N^{(a)} = 4.18 \cdot 10^7 \int_{v_0}^{0.156} \frac{1-f_1(v)}{f_2(v)-1} dv, \tag{19}$$

- nitro-phosphate solution

$$N^{(H)} = 1.37 \cdot 10^5 (0.049 - v_0) + 4.18 \cdot 10^7 \int_{0.049}^{0.156} \frac{1-f_1(v)}{f_2(v)-1} dv \quad N^{(H)} = 4.18 \cdot 10^7 \int_{v_0}^{0.156} \frac{1-f_1(v)}{f_2(v)-1} dv, \tag{20}$$

0.00625(v\_0 < 0.056  
0.049(v\_0 < 0.23

- mixed organic manure

$$N^{(T)} = 6.5 \cdot 10^7 \int_{v_0}^{0.141} \frac{1-f_3(v)}{f_4(v)-1} dv \tag{21}$$

$$f_1(v) = 3.41v [1.12 + F_1(v)]^2, \quad f_2(v) = 4.68 \cdot 10^4 v^2 [1.12 + F_1(v)]^4$$

$$f_3(v) = 3.48v [1.12 + F_1(v)]^2, \quad f_4(v) = 7.99 \cdot 10^4 v^2 [1.12 + F_1(v)]^4$$

Based on (19) - (21), in Fig. 9 the graphical dependences of residual service life of “ $\Omega$ ” cross section on the initial length of a crack  $v_0$  are developed. The nitro-phosphate solution could significantly shorten the residual service life.

## CONCLUSIONS

The analytical models to determine the service life of rail elements of fertilizer spreaders undercarriages with cyclic bending deformation, taking into account the mode of operation, are developed.

Based on (15), (16) and (17), the graphical dependences of service life  $N = N_P$  of “Z” profile rail as a stress function  $\dot{T}$  are developed (Fig.5). Corrosive environment significantly reduces the metal structure service life.

Based on (19) - (21), in Fig. 9 the graphical dependences of residual service life of “ $\Omega$ ” cross section on the initial length of a crack  $v_0$  are developed. The nitro-phosphate solution could significantly shorten the residual service life.

## REFERENCES

- [1] Andreikiv O.E., Dolins'ka I.Y., Kukhar V.Z., (2013), A mathematical model for determining the lifetime of plates with systems of cracks under long-term static breaking loads and high temperatures, *Journal of Mathematical Sciences*, pp.1-10; U.S.A.;
- [2] Andreikiv O.E., Kit M.B., Khyli' S.V., (2013), Mathematical modeling of fatigue fracture of plates with cracks under block loading, *Journal of Mathematical Sciences*, vol.190, no.6, pp.752-763, ISSN 10723374, U.S.A.;
- [3] Andreykiv . ., Darchuk .I., (1992), Fatigue failure and durability of structures ( ), *Naukova dumka*, .184, Kyiv/Ukraine;
- [4] Cherepanov G.P., (1974), *The mechanics of brittle fracture* ( ), Nauka, p.640, Moscow/Russia;
- [5] Gaydar S. ., (2011), *Protection of agricultural equipment against corrosion and wear with the use of nanotechnology* ( ), p.442, Moscow/Russia;
- [6] Panasiuk V.V., Andreykiv .Y., Parton V.Z., (1988), Fundamentals of fracture mechanics ( ), *Naukova dumka*, p.488, Kyiv/Ukraine;
- [7] Pisarenko G.S., Yakovlev .P., Matveev V.V., (1988), Handbook on resistance of materials ( ), *Naukova dumka*, .734, Kyiv;
- [8] Romaniv .N., Yarema S.Y., Nikiforchin G.N., Makhutov N. ., Stadnyk . ., (1990), Fatigue and cyclic crack resistance of structural materials ( ), *Naukova dumka*, p.680, Kyiv/Ukraine;
- [9] Severnev . ., Podlekarev N. N., Sokhadze V. Sh., Kitikov V. ., (2011), *Wear and corrosion of agricultural machinery* ( ), Belarus, Navuka, p.333, Minsk;
- [10] Schijve J., (2003), Fatigue of materials and structures in the 20th century: state-of-the-art, *Materials Science*, Vol. 39, no.3, .7-27;
- [11] Troshchenko V. ., (1981), Deformation and fracture of metals at low-cycle loading ( ), *Naukova dumka*, p.343, Kyiv/Ukraine;
- [12] Yarema S.Y., (1973), Stages of fatigue failure and its consequences ( ), *Physical and chemical mechanics of materials*, 6. .66–72.