

Stress Level & Risk of Failure Improvement Study in Subframe for Commercial Vehicle

Purnendu K Dash,

Alard College of Engineering & Management, Pune India, dash.purnendu@gmail.com, Tel: +91-8446106606

Dr.Rachayya R.Arakerimath ME,PhD[Mech],

Dean (Academics) GH Raisonni Institute of Engineering & Technology. Pune, India, rrakerimath@gmail.com Tel: +91-8805026109

Abstract— A subframe is a structural component of vehicle, that uses a discrete, separate structure within a larger body-on-frame or unit body to carry certain components, such as engine, drive train and / or suspension. The subframe is bolted and or welded to form a single assembly, which is bolted to the vehicle frame or cabin structure. The principal purposes of using a subframe are, to spread high chassis loads over a wide area of relatively thin sheet metal of body shell, and to isolate vibration and harshness from the rest of the body. Weight optimized design of subframe has many distinguished advantages. Since, it carries load of engine, suspension and steering components of the vehicle, it has to be designed for least weight, but without compromising the strength. It requires thorough study of current design, areas of failure and key design considerations. Care should be taken while design to understand properties of material and its suitability for various production methods. A technical study needs to be done to derive most cost-efficient concept. The motive behind the project is to optimize subframe for commercial vehicle application. Optimization has to be done in terms of material selection, no of parts selection, manufacturing process of individual parts as well as assembly so as to reduce the overall weight to a minimum value by extensive use of finite element method.

Keywords—finite element analysis, optimization, subframe, structural durability analysis, risk of failure, automotive, CAE

INTRODUCTION

Recent research and development capability of automobile area is concentrated on developing high-performance, light-weight and high-efficiency vehicle. Especially related to structural design of the vehicle, researches to reduce weight of components and developing cost have been actively performed. Structural design of the vehicle should be done with simultaneously considering many types of performance requirements, e.g. structural safety against the crash, fatigue life of the components, noise, vibration and harshness (NVH) performances, and kinematic and compliance (K&C) characteristics influencing to the ride and handling (R&H) performances. Design requirements were selected for structural stiffness and fatigue strength, NVH performance, K&C performances, and weight. To obtain the design solution satisfying the aforementioned design requirements, the shape and thicknesses of the subframe component were considered as design variables [8]. The necessities for light weight design as well as reducing fuel consumption are greatly increasing as environment friendly and high efficiency vehicle technology is required in these days [4]. For example, in an automobile with its power train contained in a subframe, forces generated by the engine and transmission can be damped enough that they will not disturb passengers. Subframes are used in modern vehicles to reduce the overall weight and cost. In addition a subframe yields benefits to production in that, subassemblies can be made which can be introduced to the main body shell when required on an automated line. Therefore, the designing of the subframe has the important influence to the main frame's quality and service life [2].

There are generally three basic forms of the subframe.

- A simple "axle" type which usually carries the lower control arms and steering rack.
- A perimeter frame which carries the above components but in addition supports the engine.
- A perimeter frame which carries the above components but in addition supports the engine, transmission and possibly full suspension. (As used on front wheel drive cars)

A subframe is usually made of pressed steel panels that are much thicker than body shell panels, which are welded or spot welded together. The use of hydro formed tubes may also be used.

METHODOLOGY FOR EXECUTION

Following are the steps followed.

1. Problem definition

2. Constraints
3. Expected outcome
4. Design calculation and formulation
5. 3D modeling of parts, subassemblies and assemblies
6. Design for manufacturing, assembly, service & DFMEA
7. Finite element analysis
8. Iterations for part profile, material and assembly to get stress below yield limit.
9. Conclusion
10. References

1. Problem Definition

Need to optimize a subframe for minimum overall weight, with less number of components, with less welding, without compromising its strength. It requires thorough study of current design, areas of failure and key design considerations. Care should be taken while design to understand properties of material and its suitability for various production methods. A technical study is done to derive most cost-efficient concept. The procedure consists of study of subframe system and its standard design procedure, preparation of CAD data for existing product, analysis of the current subframe and comparison of the results with field data, co-relating the both parameters and taking reference for future design. The CAE analysis using Hypermesh and Nastran to see the probable areas of failure and room for further weight reduction at safest areas.

The final design will be evaluated in terms of stiffness, strength, stress and deflection of the new subframe compared to existing design. In the field of Automotive there is a continuous requirement for low weight, higher fuel efficiency and commonisation of maximum parts to reduce product design life cycle. This project contains development of a common subframe for independent front suspension system for a commercial vehicle and its variant

2. Constraints

- Subframe should carry 15% more load as compare to base subframe.
- No changes in suspension, steering and engine mounting hard points
- Minimum changes to existing tooled up parts.
- Minimum clearances of 10mm with surrounding static parts and 25mm with surrounding dynamic parts.
- Maximum use of existing assembly tooling and assembly fixtures.
- Cost should be comparable with existing subframe.
- Assembly subframe weight increase allowable up to 10% as compare to existing subframe
- Common subframe for all variants vehicles.

3. Expected Outcome

- Maximum strength (stress value less than material yield stress)
- Minimum deflection (torsional and bending stiffness)
- Minimum weight (initial weight target is ~ 25kg)
- Life prediction (durability analysis for initial target of 1.6 lakh kms of vehicle)

4. Design Calculation and Formulation

i) Mathematical Modeling:

A mathematical model is a description of a system using mathematical concepts and language. The process of developing a mathematical model is termed mathematical modeling. A mathematical model is an abstract model that used mathematical language to describe the behavior of system. Mathematical models can take many forms, including but not limited to dynamical systems, statistical models, differential equations or game theoretic models. These and other types of models can overlap, with a given model involving a variety of abstract structures.

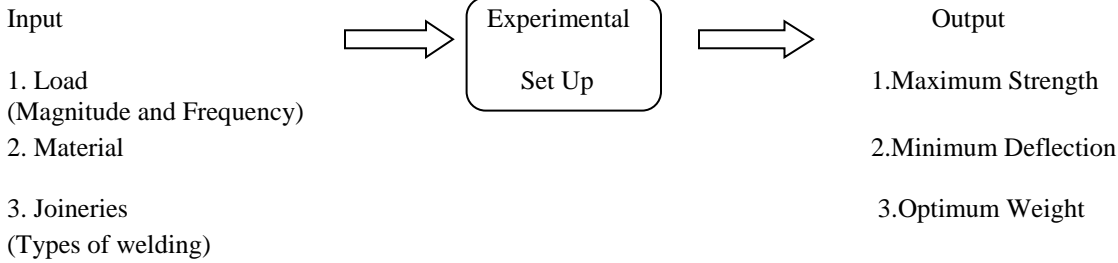

Fig 1 Mathematical modeling

ii) Parameter Selection:

S No	Parameter	Level 1	Level 2
1	Geometry of part (s)	G1	G2
2	Material	M1	M2
3	No. of Parts	N1	N2
4	Joinery of parts	J1	J2

Table 1 Parameter Selection

iii) 3D modeling of parts, sub assemblies and assemblies

CAD software Pro/E is used for 3D modeling of parts, subassemblies and assemblies.

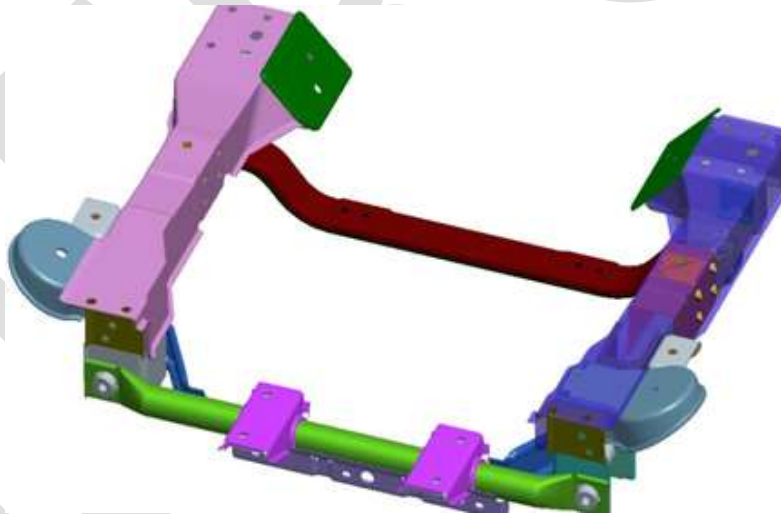

Fig 2 Base Subframe (Iteration 1)

Subframe for small commercial vehicle consist of mainly four sub assemblies.

- Front cross member assembly,
- Rear cross member assembly,
- Side member assembly LH,
- Side member assembly RH

In total there are approximately more than 80 parts in subframe assembly. Subframe side member is the main source of load carrier. It supports engine at rear end, support other reinforcement bracket, supports suspension load through wishbone bushes. Front cross member supports the steering load while rear cross member makes the assembly subframe intact. Coil spring mounting bracket along with vertical tower bracket supports suspension load. Rear cross member supporting bracket supports load of rear bushes.

iv) Design for Manufacturing

Simulation tool (hyper form) is used to know thickening and thinning of sheet metal components in forming operation by use of blank, die and punch. More than 20% thinning is shown as critical area, which needs modification. The fillet radius as well as profile updation required to make the part manufacturable.

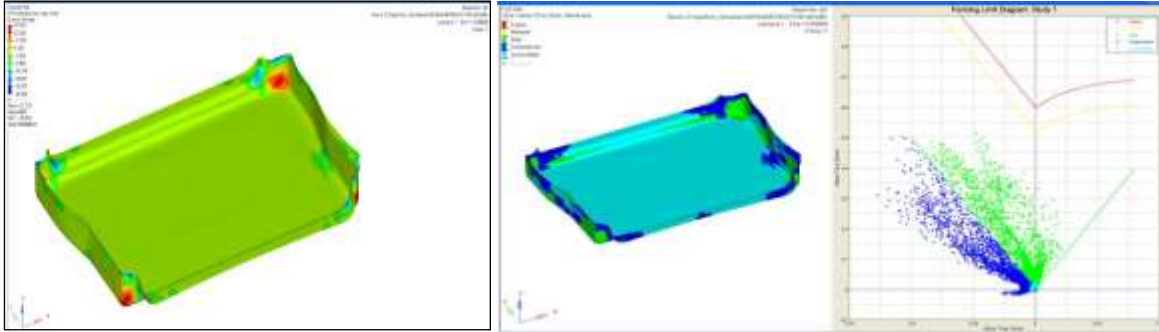

Fig 3. Bracket manufacturing feasibility through Hyper Form

Bend radius, notches, corner relief, part depth also verified with respective part supplier for manufacturing feasibility in addition to analysis tool.

v) Design for Assembly

- No interference within subframe parts ensured in Creo (PRO/E) by using global interference option and part geometry updated if found any.
- Required clearances within surrounding parts ensured in Creo (PRO/E). Part geometry updated if found any.
-

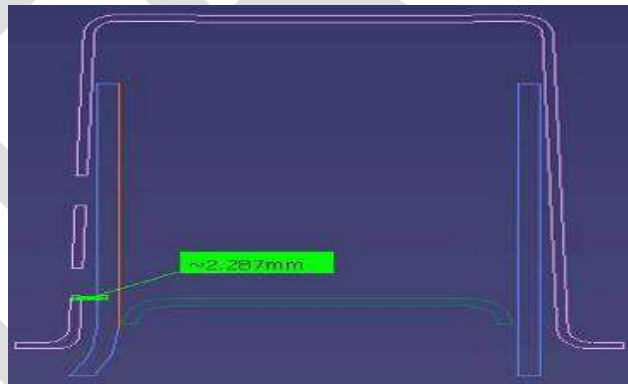

Fig 4 Assembly clearance & interferences checking

vi) Service Load Analysis

Based on Road Load Data using wheel force transducer the force at each wheel received and the same load is applied in ADAMS analysis to find out the force and moment at each critical location.

viii) Finite Element Analysis

- Hypermesh software is used for meshing.
- Type of mesh used is shell and solid
- For bolt joint beam elements joined with rigid element
- Welded joint present by shell elements with thickness equal to least thickness of parent component and twice the thickness for plug welds

- Closures, power train are represented with mass element
- Total number of elements calculated to be ~ 3 Lakhs

ix) Critical Assumptions during CAE analysis

- Load transfer through surface contacts is ignored.
- All welds are assumed adequate (i.e. they will not fail).
- Assembly loads (bolt preload) are not considered.

x) Material Properties for different Sheet Metal Parts

Material	Yield Strength (MPa)	Acceptable limits for ultimate load case > 1.3 YS (MPa)	Acceptable limits for durability load case > 0.9 YS (MPa)
Fe 410, SM 400A JIS - G - 3106	255	300	230
E34, DIN QSTE 340 TM	340	440	300
BSK46, DIN QSTE 460 TM	460	590	410
CEW1, IS 3074	370	480	330
40Cr4, IS 5517	700	910	630

Table 2 Material used for different parts

2. Discussion of Analysis for New Subframe Iteration 1

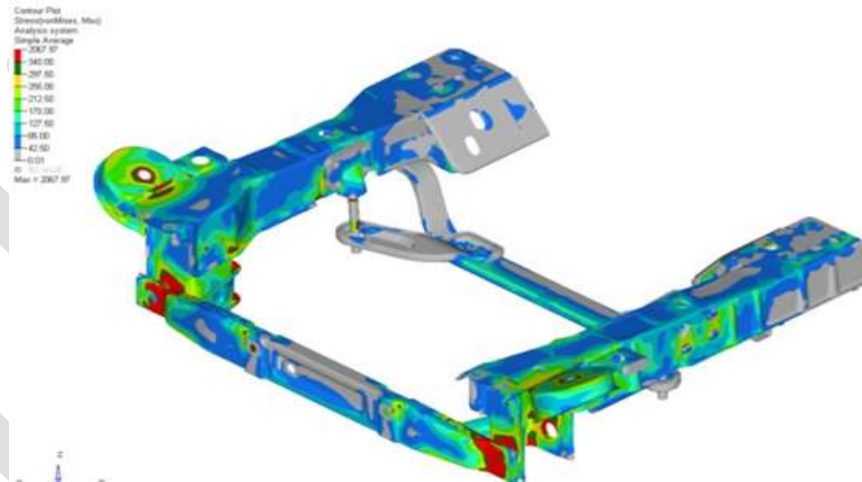

Fig. 5 Stress plot for complete sub frame (Iteration 1)

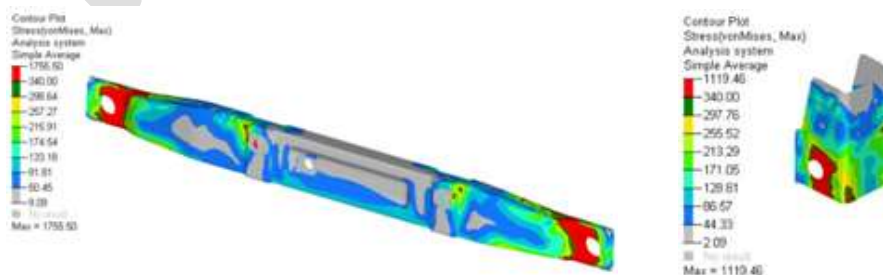

Fig 6 Stress plot for front cross member & vertical bracket (Iteration 1)



Fig 7 Stress plot for side member & Z bracket (Iteration 1)

Analysis done at 33% overload on gross vehicle weight. From all load cases front both pot hole shows the maximum stress at front cross member end mounting area. Because of this load case in addition to front cross member the vertical tower bracket at same location also shows more stress.

SI No	Description	Max Stress (N/mm ²)	ROF Iteration 1	Remarks
1	Front cross member	1755	> 5.0	Stress is more at bush mounting area
2	Vertical tower bracket	1119	> 3.2	Stress is more at bush mounting area
3	Side member	654	> 1.9	Stress is more at spring mounting area
4	Z bracket	907	> 2.7	Stress is more at bush mounting area

Table 3 Stress & ROF values for Iteration 1

3. Physical Verification of CAE result

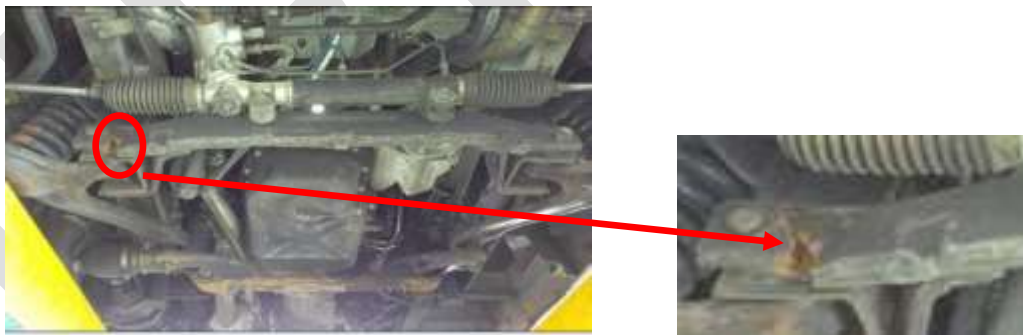

Fig. 8 Actual Failure of Front cross member (Iteration 1)

As shown in the durability testing the front cross member failed at the location where stress is showing high. This correlated CAE result, assumptions and boundary conditions. Hence the focus should be on strengthening of front cross member. Strength increase of front cross member to be achieved by

- i) Modifying the material to higher grade
- ii) Modifying the profile of parts
- iii) Modifying the load path by changing vertical bracket & Z bracket.
- iv) Modifying welding position

4. Final Optimization

To get the required life for durability following changes are done in comparison with existing subframe (Iteration 1)

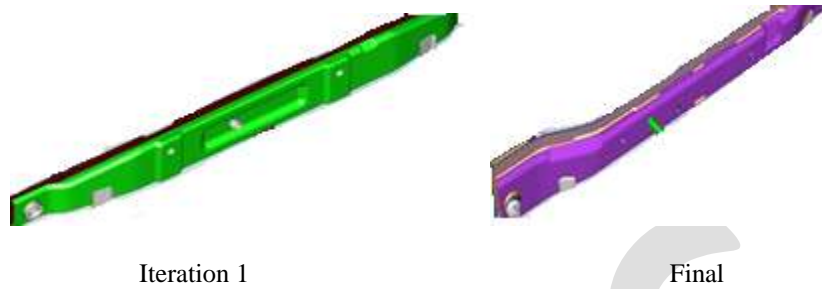

Fig 9 Front cross member profile updation

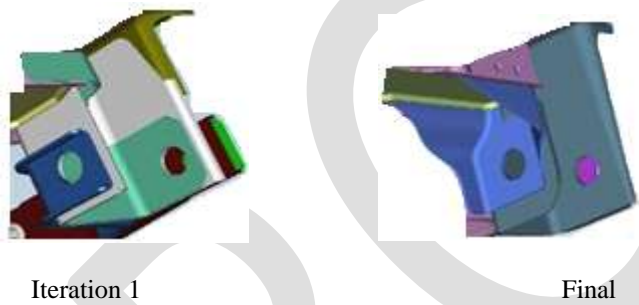

Fig 10 Vertical mounting bracket profile updation

5. CAE Result & Analysis of Final Subframe

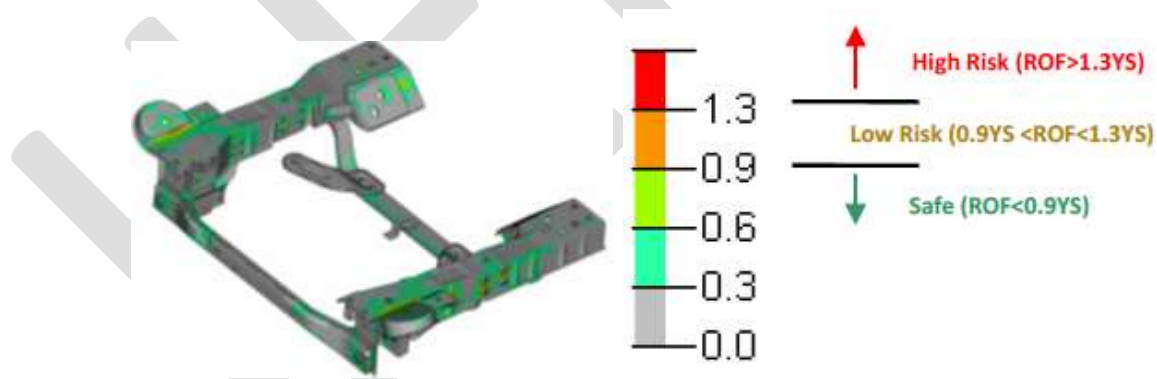

Fig 11 Stress plot for complete sub frame (final)

Risk of Failure (ROF):-

ROF is being used to describe the safe and risk zones for ultimate load cases

$ROF = \text{Predicted stress} / \text{Yield strength of respective material}$

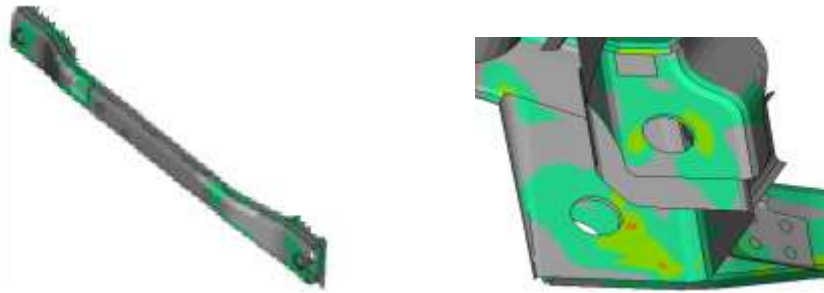

Fig 12 Stress plot for front cross member & Vertical Bracket (final)

Sl No	Description	Max Stress (N/mm ²)	ROF Final	Remarks
1	Front cross member	322	< 0.8	Stress within elastic limit
2	Vertical tower bracket	390	< 0.85	Stress within elastic limit & higher value at local zone
3	Side member	289	< 0.85	Stress within elastic limit & higher value at local zone
4	Z bracket	320	< 0.75	Stress within elastic limit & safe

Table 4 Stress & ROF values for final Iteration

5. Durability Testing

The physical subframe is tested to correlate the CAE with actual. The subframe is assembled in vehicle & durability testing conducted based on Road Load Data (RLD) collection.



Fig 13 Actual part after testing

6. Conclusion

From the above physical testing the subframe cleared the required testing cycles which is equivalent to approximately 2lakh kms on vehicle and no failure observed. The end portion of cross member stress is now within safe limit. The complete optimization is done keeping in mind all the constraints provided at initial. Not only the profile and material helps us to reduce stress it is welding positions which also plays a crucial role. During this development the assembly sequence is also finalize to get the required critical mounting hard points. Further to this hydro form subframe options to be evaluated to reduce number of parts which will simultaneously reduce the total weight of the subframe and ease of manufacturing?

REFERENCES:

- [1] A Kocanda, H Sadlowska, Automotive component development by means of hydro forming, Warsaw University of Technology, Warszawa, Poland, 2008
- [2] Chen Yanhong, Zhu Feng, The Finite Element Analysis and The Optimization Design of the Yj3128-type Dump Truck's Sub-Frames Based on ANSYS, Procedia Earth and Planetary Science 2, 2011
- [3] Chung-Kyu Park, Robert Thomson, Aleksandra Krusper, Cing-Dao (Steve) Kan, The Influence of subframe Geometry on a Vehicle's Frontal Crash response, National Crash Analysis Center, George Washington University, Washington, DC, USA, VTI-Swedish National Road and Transport Research Institute, Gothenburg, Sweden, SAFER-Vehicle and Traffic Centre, Chalmers University of Technology, Gothenburg, Sweden, 2009.
- [4] Dae Up Kim, Young Choi, Bong Yong Kang, Joon Hong Park, Hong Tae Yeo, Jae Hun Kim and SangWoo Park, A Study on Process Design of Automobile Parts Using Extruded Material by Die Forming, Hindawi Publishing Corporation. Advances in Mechanical Engineering, Volume, 2014.
- [5] Elsayed Mashaly, Mohamed El-Heweity, Hamdy Abou-Elfath, Mohamed, Finite element analysis of beam-to-column joints in steel frames under cyclic loading, Osman Alexandria Engineering Journal, 2011
- [6] Ibrahim Elkersh, Experimental investigation of bolted cold formed steel frame apex connections under pure moment, Ain Shams Engineering Journal, Suez Canal University, Egypt, 2010
- [7] Izzuddin bin Zaman Bujang, Roslan Abd. Rahman, Application of dynamic correlation technique and model updating on truck chassis, Faculty of Mechanical Engineering, College University Technology Tun Hussein Onn (Kuittho) and Faculty of Mechanical Engineering, University Technology of Malaysia, 2009
- [8] Jung-Min Park¹, Gabseong Lee, Byung-Lyul Choi, Dong-Hoon Choi, Chan-Hyuk Nam, Gi-Hoon Kim, Multidisciplinary Design Optimization of Subframe Component of Vehicle Front Suspension, 9th World Congress on Structural and Multidisciplinary Optimization, Shizuoka, Japan, June 2011.
- [9] Jong Yop Kima, Naksoo Kima, Man-Sung Huhb, Optimum blank design of an automobile sub-frame, Department of Mechanical Engineering, Sogang University, Shinsu-dong, Mapo-ku, Seoul, South Korea, July 1998
- [10] A. Hamdi, B. Yannou and E. Landel, Design target cascading for vibroacoustic conceptual design of an automobile subframe, International design conference, Dubrovnik, May 2004.
- [11] L. Gaines, R. Cuenca, F. Stodolsky, Potential Automotive uses of wrought magnesium Alloys, Automotive Technology Development, Detroit, Michigan, November 1996
- [12] Rick Borns, Don Whitacre, Optimizing Design of aluminum suspension components using an integrated approach, SAE Paper 05M-2, June 2008