

Modeling and Analysis of RBTS IEEE-6 BUS System Based On Markov Chain

Miss.Vijayalaxmi Dharwad, PG scolar of Electrical and Electronics Engineering Department SDMCET, Dharwad-58002, vijaya.dharwad@gmail.com

Dr.S.B.Karjagi Professor of Electrical and Electronics Engineering Department, SDMCET, Dharwad-58002, sbkarajgi@gmail.com

Abstract— Modern facility is incredibly vast and extremely tough to keep up. The reliability evaluation of the ability system is additionally very complex and extremely tedious task. Whole power grid is separated in to generation, transmission and distribution systems. In this work we are concentrating solely on the reliability analysis of the generation system. There are various methods are available to judge the reliability of the generation system. These methods are differing in time consumption and technology. Compared to simulation method Markov method has more advantages. In Markov chain and Frequency and Duration of system, transient and steady-state probabilities are calculated using RBTS IEEE-6 BUS System.

Keywords— Reliability, Adequacy, Generation model, Load model, Risk indices, Markov chain, Frequency and Duration of states, De-rated states.

INTRODUCTION

The reliability evaluation of whole power system is very tedious task. The reliability evaluation of whole power system is sub divided into system security and system adequacy. Security of the system deals, the response of the system to the dynamic perturbations which are arising within the system. Adequacy of the system deals, the ability of sufficient energy from the generating units to meet the load requirement.

In the practical, during dynamic perturbations, the response of the power system is not easy to identify. Therefore in this work we are concentrating only on the adequacy assessment of the power system. The power system is sub divided in to three functional zones to evaluate the reliability of the system. The functional zones are generation facility, transmission facility and distribution facility. Using these functional zones the power system is again divided in to three hierarchical levels as shown in figure 1[1][2][3].

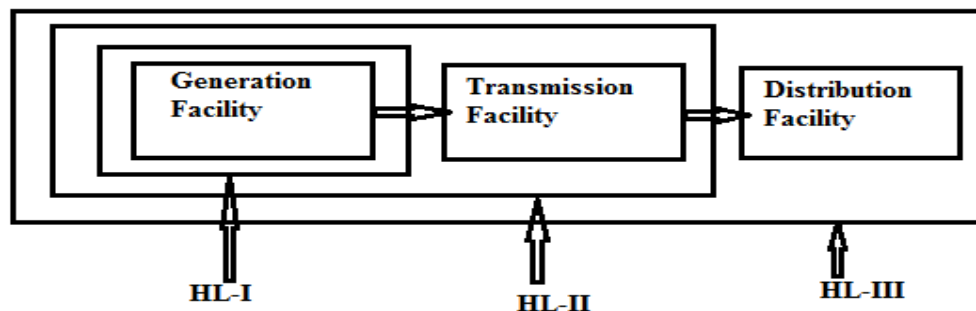

Fig 1: functional zones and hierarchical levels.

In figure 1 the HL-I deals, the reliability evaluation of only generation system. HL-II deals, the realibility evaluation of the both generation and transmission sysytems. HL-III deals, the reliability evaluation of the generaion, transmission and distribution systems. In this work we are concentrating on the reliability evaluation of the generaion system (HL-I).

Adequacy assessment of the generation system deals, the performance of the generating units to meet the required load demand under constraints. In the adequacy assessment the Generation system and the peak load demand is considered. The conductor line is ignored during this assessment as shown in figure2 [1][2][3]

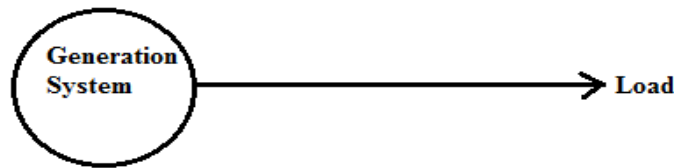

Fig 2: adequacy assessment of HL-I.

ADEQUACY ASSESSMENT OF GENERATION SYSTEM

Adequacy assessment of the generation system has three steps to carry out reliability evaluation as shown in figure 3. First, create the generation model using COPT. Second, create load model using peak loads. Third, combine these two models to get risk model. Risk model is to find the risk indices of the adequacy assessment [1][2][3].

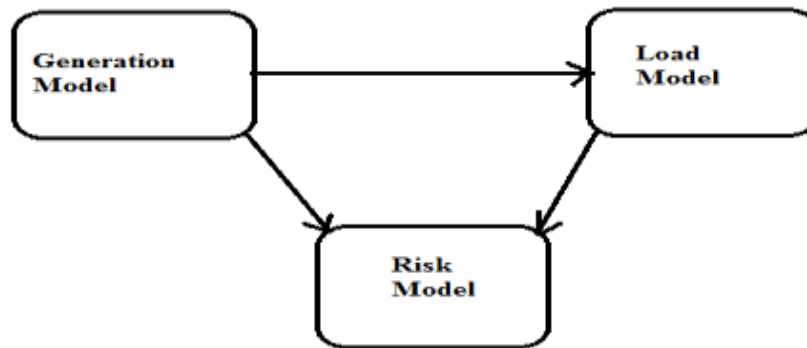

Fig 3: reliability evaluation of generation system.

GENERATION MODEL

There are many methods to create generation model. Adequacy assessment is sub divided into deterministic approach and probabilistic approach. The deterministic approach does not consider all kinds of perturbations in the analysis compared to probability approach [4][5]. Probability approach is sub divided into Monte Carlo simulation and analytical method. Monte Carlo simulation requires more time and it is slow convergences compared to analytical method [6][7]. Therefore during this work we have a tendency to concentrating solely on analytical ways.

In conventional method adequacy assessment of the generation system is carried out by creating capacity outage probability table (COPT). COPT is created by using generating capacity units and Forced Outage Rate (FOR) of generating units. In analytical method Markov process is explained. It will be explained in section III [8].

LOAD MODEL

Load model is created by using daily or monthly or yearly peak loads with respect to time in seconds or minutes or hours as shown in figure 4. Where Q_k is the outage capacity and t_k is the time at outage of unit k [1][2][5].

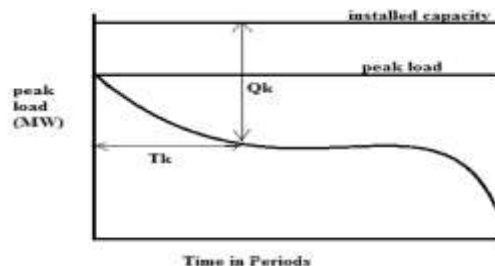

Fig 4: load model

RISK MODEL

Risk model is to find the risk indices such as LOLE, LOEE, EENS, Frequency and duration of system etc. In this work we are concentrating on the Frequency and Duration of states, transient and steady state probabilities.

FREQUENCY AND DURATION OF STATES

The frequency and duration can be calculated as shown in figure 5 [3].

Frequency of encountering State i

$$= P(\text{being in State } i) \times (\text{rate of departure from State } i)$$

$$= P(\text{not being in State } i) \times (\text{rate of entry into State } i).$$

Mean Duration in State i,

$$m_i = 1 / \text{rate of departure from State } i. \quad (\text{eq-1})$$

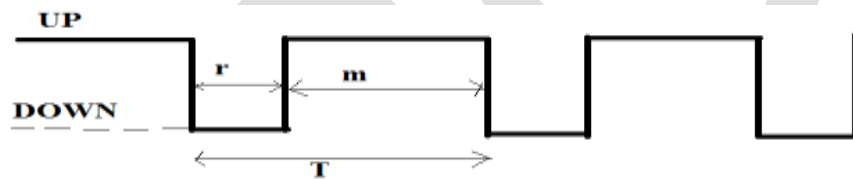

Fig 5: mean time/state diagram of a single component system.

Where,

$$m = \text{MTTF} = 1 / \lambda$$

$$r = \text{MTTR} = 1 / \mu$$

$$T = \text{MTBF} = m + r = 1 / f$$

And

$$\text{Availability} = m / (m + r) = m / T = 1 / \lambda \times T = f / \lambda$$

$$\text{Unavailability} = r / (m + r) = r / T = 1 / T \times \mu = f / \mu$$

MARKOV CHAIN

Markov chain is one of the analytical methods which are used measure the reliableness of the facility system. A Markov process has simplest modeling approach, converges, applicable to modeling of complicated system.. Therefore In this work Markov chain is used to appraise the reliableness of the generation system.

Markov chain is used to examine the future probabilities of the system. It does not depend on the past history data of the system or memory less system. The probabilities of the system are carried out using the present data of the system. Using these results we can predict the behavior of the system in future also used for extension of the power system. Therefore Markov chain is widely used in the all engineering applications [10][12]

In markov chain the reliability is calculated using FOR (Forced Outage Rate), which is known as un-availability (U) and it is given by,
 688 www.ijergs.org

$$FOR = \frac{\text{forced outage hours}}{\text{in service hours} + \text{forced outage hours}}$$

$$FOR = \frac{\lambda}{\lambda + \mu} \quad A = 1 - FOR$$

Where,

A = unit availability λ = unit failure rate
 μ = unit repair rate U = unit unavailability.

Markov model is represented in terms of number of states and its state transitions. The two-state markov model is shown in figure 6. Where state 1 represents the unit is in upstate and state 2 represents the unit in down state.

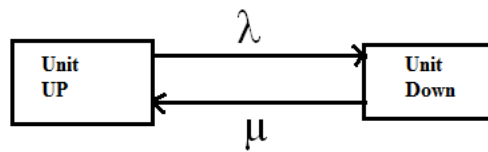

Fig 6: Two-state model of the Markov chain

From figure 6 we can obtain the steady state values for probabilities of each state. Using these values we can predict the behavior of the system. The steady state probabilities can be written as [11][13],

$$P1 = P_{up}, \quad P2 = P_{down}.$$

$$P1 = \lambda / (\lambda + \mu), \quad P2 = \mu / (\lambda + \mu).$$

$$A = 1 - \prod_{i=1}^n Q_i \quad Q_p = \prod_{i=1}^n Q_i$$

$$\frac{1}{\lambda_p} = \left(\frac{1}{\lambda_1} + \frac{1}{\lambda_2} \dots \dots + \frac{1}{\lambda_n} \right) - \left(\frac{1}{(\lambda_1 + \lambda_2)} + \frac{1}{(\lambda_1 + \lambda_3)} \dots \dots + \frac{1}{(\lambda_1 + \lambda_n)} \right) + \left(\frac{1}{(\lambda_1 + \lambda_2 + \lambda_3)} + \dots \dots \dots + \left((-1)^{n+1} \frac{1}{\sum \lambda_n} \right) \right)$$

(eq-2)

Where,

A = unit availability
 Q_i = unit unavailability of unit i
 Q_p = unavailability of parallel units
 λ_p = failure rate of parallel units.

The equations of state probabilities are, P₁+P₂+P₃+P₄=1

$$\frac{dP_1}{dt} = -(\lambda_1 + \lambda_2)P_1(t) + \mu_1P_2(t) + \mu_3P_3(t)$$

$$\frac{dP_2}{dt} = \lambda_1P_1(t) - (\mu_1 + \lambda_2)P_2(t) + \mu_2P_4(t)$$

$$\frac{dP_3}{dt} = \lambda_2P_1(t) - (\mu_2 + \lambda_1)P_3(t) + \mu_1P_4(t)$$

$$\frac{dP_4}{dt} = \lambda_2P_2(t) + \lambda_1P_3(t) - (\mu_1 + \mu_2)P_4(t)$$

(eq-3)

In general,

$$\frac{dP}{dt} = A P(t)$$

Where

A= stochastic transitional probability matrix, P(t)= vector of the state probabilities

$$A = \begin{bmatrix} -(\lambda_1 + \lambda_2) & \lambda_1 & \lambda_2 & 0 \\ \mu_1 & -(\lambda_2 + \mu_1) & 0 & \lambda_2 \\ \mu_2 & 0 & -(\lambda_1 + \mu_2) & \lambda_1 \\ 0 & \mu_2 & \mu_1 & -(\mu_1 + \mu_2) \end{bmatrix}$$

Using the transition matrix several reliability indexes is obtained like the chances of every state with relation to time, the system steady state probability, and MTTF are quickly obtained. These results will be used in the operation, maintenance and programming of power grid in line with the various interval of Δt .

Applying Laplace transformer to the eq-1

$$P(t) = k_0e^{-\lambda_1 t} + k_1e^{-\lambda_2 t} + k_2e^{-\lambda_3 t} + \dots \dots \dots \quad (\text{eq-4})$$

Where,

$k_0, k_1, k_2 \dots$ are coefficients depend on the equation and initial conditions.

$\lambda_1, \lambda_2, \lambda_3 \dots$ are eigen values of matrix A.

AVAILABILITY OF WHOLE GENERATION SYSTEM

The states of the power system is divided into acceptable W and unacceptable state U, which are $W = \{P_1, P_2, P_3\}$ $U = \{P_4\}$.

$$A(t) = \sum_{k \in W} P_k(t) = P_1(t) + P_2(t) + P_3(t) \quad (\text{eq-5})$$

CASE STUDY

The adequacy assessment is carried out by using RBTS IEEE-6 BUS SYSTEM. The single line diagram of RBTS system is shown in figure 7. The generation system data is shown in table 1 and load demand is shown in figure 8 and figure 9 [9].

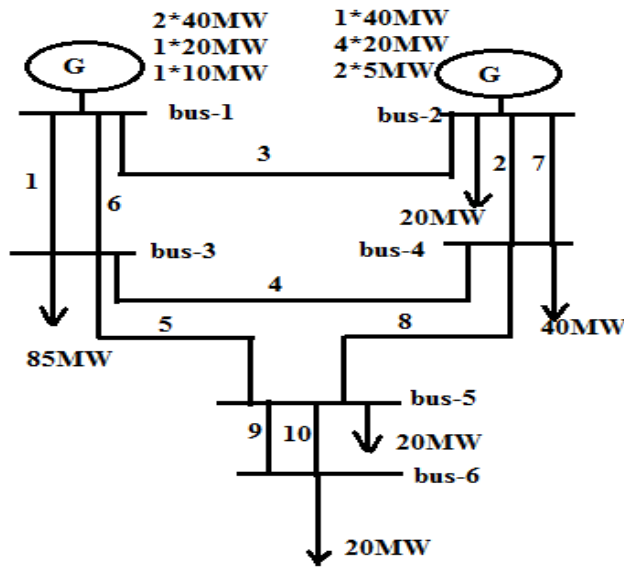

Fig 7: Single line diagram of the IEEE 6-BUS RBTS.

Table1: Generation system data

No: of Units	Unit Size(MW)	Type of generator	Failure rate/yr= λ	Repair rate/yr= μ	FOR
2	5	Hydro	2.0	198.0	0.010
1	10	Thermal	4.0	196.0	0.200
4	20	Hydro	2.4	157.6	0.015
1	20	Thermal	5.0	195.0	0.025
1	40	Hydro	3.0	147.0	0.020
2	40	Thermal	6.0	194.0	0.030

SIMULATION RESULTS

The Markov model for IEEE 6-BUS SYSTEM is shown in figure 8. In this system we are considering one component at bus 1 and second component at bus 2. Therefore IEEE 6-BUS SYSTEM is represented as TWO-COMPONENT MODEL. Failure rates of the two components are λ_1 and λ_2 . Repair rates of the two components are μ_1 and μ_2 . Using (eq-2) the values of failure and repair rates are calculated and is given below,

$$\lambda_1 = 2.3182e-4/\text{hr} \quad \mu_1 = 2.3214/\text{hr}$$

$$\lambda_2 = 1.141609e-4/\text{hr} \quad \mu_2 = 38.0517/\text{hr}$$

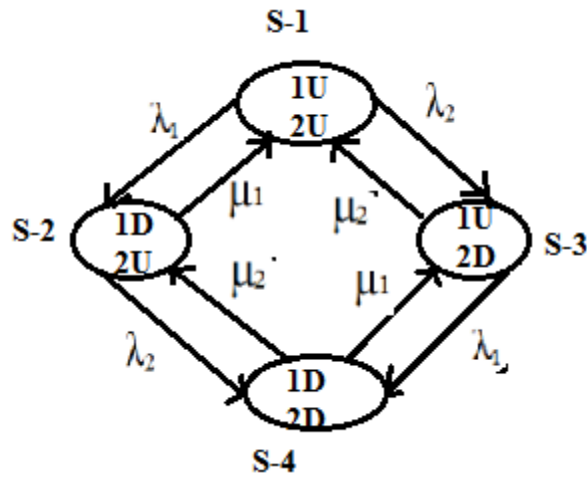

Fig 8: Two-component Markov model.

From (eq-3)

$$A = \begin{bmatrix} -3.4598e-4 & 2.3182e-4 & 1.1416e-4 & 0 \\ 2.3214 & -2.3215 & 0 & 1.1416e-4 \\ 38.0500 & 0 & -38.0519 & 2.3182e-4 \\ 0 & 38.0517 & 2.3214 & -40.3731 \end{bmatrix}$$

Substituting all these values in eq-4, we obtain probability of each state with respect to time, are **TRANSIENT PROBABILITIES** or **SHORT TERM PROBABILITIES**.

$$\begin{aligned} P1(t) &= 0.9995 + ((4.788e-5) * \exp(-2.3218 * t)); & P2(t) &= 9.985e-5 + ((1) * \exp(-2.3218 * t)); \\ P3(t) &= 2.98e-6 + ((.1554) * \exp(-2.3218 * t)); & P4(t) &= 2.98e-10 + ((.4906) * \exp(-2.3218 * t)); \end{aligned} \tag{eq-6}$$

Plotting these probabilities vs time as,

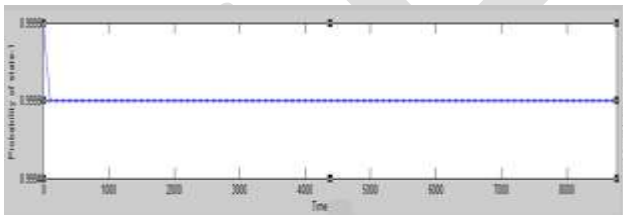

Fig 9: Probability of state-1.

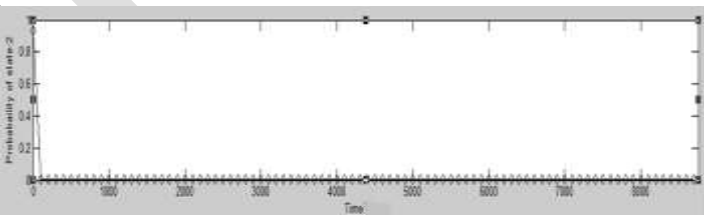

Fig 10: Probability of state-2.

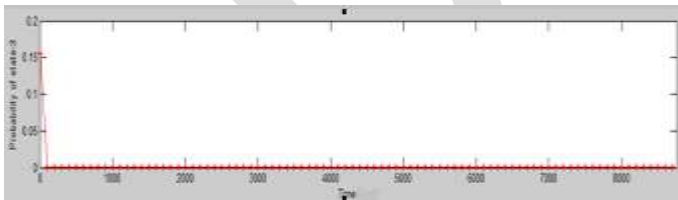

Fig 11: Probability of state-3.

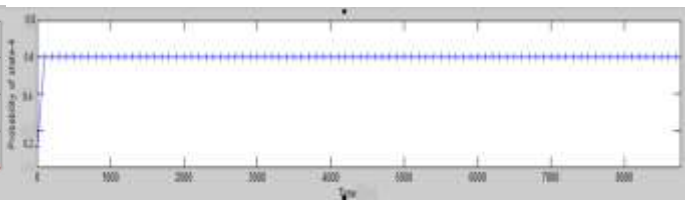

Fig 12: Probability of state-4.

As $t \rightarrow \infty$ the eq-6 becomes, is **STEADY STATE PROBABILITIES** or **LONG TERM PROBABILITIES**.

$$\begin{aligned} P1 &= 0.9995 \\ P2 &= 9.985e-5 \\ P3 &= 2.98e-6 \\ P4 &= 2.98e-10 \end{aligned}$$

OR

The state operations are,

State 1: P1upXP2up

State 2: P1down x P2up

State 3: P1downXP2up

State 4: P1downXP2down

The steady state probabilities are,

State 1: $\mu_1 \mu_2 / (\lambda_1 + \mu_1)(\lambda_2 + \mu_2) = 0.999897$

State 2: $\lambda_1 \mu_2 / (\lambda_1 + \mu_1)(\lambda_2 + \mu_2) = 9.9851e-5$

State 3: $\mu_1 \lambda_2 / (\lambda_1 + \mu_1)(\lambda_2 + \mu_2) = 2.9998e-6$

State 4: $\lambda_1 \lambda_2 / (\lambda_1 + \mu_1)(\lambda_2 + \mu_2) = 2.9956e-10$.

Frequency and duration of the each state is calculated from (eq-1) as shown in table 4 and table 5

Table 4: Frequency and Duration of states

State no	State probability	Rate of departure	Frequency of encounter in state i	Mean duration of state i
1	P1=P1up x P2up	$\lambda_1 + \lambda_2$	$P1x(\lambda_1 + \lambda_2)$	$1/(\lambda_1 + \lambda_2)$
2	P2=P1down x P2up	$\lambda_2 + \mu_1$	$P2x(\lambda_2 + \mu_1)$	$1/(\lambda_2 + \mu_1)$
3	P3=P1up x P2down	$\lambda_1 + \mu_2$	$P3x(\lambda_1 + \mu_2)$	$1/(\lambda_1 + \mu_2)$
4	P4=P1down x P2down	$\mu_1 + \mu_2$	$P4x(\mu_1 + \mu_2)$	$1/(\mu_1 + \mu_2)$

Table 4: Frequency and Duration of states

State no and probability	Rate of departure	Frequency of encounter in state i (f/hr)	Mean duration of state i (hr)
P1=0.999897	3.4598e-4	3.45944e-4	2890.3404
P2=9.9851e-5	2.3215	2.3180e-4	0.4307
P3=2.9998e-6	38.0519	1.14148e-4	0.0262
P4=2.9956e-10	40.3731	1.2094e-8	0.0247

From (eq-5) the availability of generation system is **A=0.9960**

DE-RATED STATES

There are six-units in Two-components, therefore there will be $2^6= 64$ states. The Markov model is obtained by considering de-rated states. It is shown in figure 13 all the state transitions have not shown in the figure13.

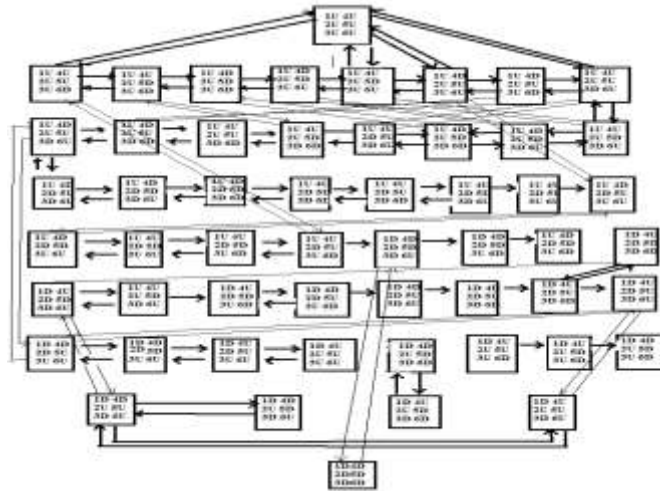

Fig 13: Markov Model of the generation system by considering De-rated states.

The Steady-State Probabilities of each state of Markov Model of the generation system by considering De-rated states are,

STATE NO	PROBABILI TY	STATE NO	PROBABILIT Y
P1	0.921400	P28	3.5898E-8
P2	9.2389E-5	P29	2.3571E-6
P3	1.4000E-6	P30	3.5981E-4
P4	0.0140	P31	1.3469E-14
P5	2.8571E-8	P32	1.3501E-10
P6	0.1686	P33	8.8649E-9
P7	2.8638E-4	P34	8.8443E-13
P8	1.8760E-6	P35	6.6001E-13
P9	0.01880	P36	4.3376E-10
P10	3.8376E-4	P37	4.3438E-7
P11	5.8446E-6	P38	6.6155E-9
P12	5.8310E-10	P39	2.1284E-5
P13	3.82873E-8	P40	4.3438E-7
P14	1.8760E-6	P41	6.6155E-9
P15	2.8571E-8	P42	6.6001E-13

P16	2.8638E-4	P43	3.2340E-11
P17	0.0236	P44	4.3337E-11
P18	4.8216E-4	P45	5.2531E-13
P19	9.8401E-6	P46	2.5740E-11
P20	1.14644E-3	P47	1.2612E-9
P21	1.4614E-11	P48	8.2817E-8
P22	2.8638E-4	P49	8.3010E-4
P23	4.8104E-8	P50	1.6940E-5
P24	7.3432E-6	P51	3.4573E-7
P25	0.0236	P52	5.2654E-9
P26	7.3432E-6	P53	2.5740E-11
P27	0.09792	P54	2.8638E-4

CONCLUSION

The modeling and analysis of IEEE-6 bus system using Markov model has resulted that the probability of acceptable states is decreasing as time scale is increases and probability of unacceptable state is increasing as time scale is increases in figure 9-12. Frequency and duration values of each state has resulted that, frequency and duration values are decreases as state increases. The frequency and duration of state-1 is highest. Complexity has increased by considering de-rated states but it gives same results of Two-component model values by neglecting very low values.

REFERENCES:

- [1] Roy Billington, "Reliability Assessment of Large Electric Power Systems", Kluwer academic Press/springer india, 2008
- [2] R.Billington and a.N.allen, "Reliability Evaluation of Engineering Systems; Concepts and Techniques", springer, 1992.
- [3] R.Billington and R.N.Allen, "Reliability Evaluation Of Power System", second edition, 1996.
- [4] Yaw-Juen Wang, "A Method Integrating Deterministic and Stochastic Approaches for the Simulation of Voltage Unbalance in Electric Power Distribution Systems", IEEE Member, IEEE Transactions On Power Systems, Vol. 16, No. 2, May 2001.
- [5] L. S. Low L. Goel "Incorporating Deterministic Criteria in the Probabilistic Framework for Composite Generation and Transmission Systems," Senior Member, IEEE, School of Electrical and Electronic Engineering Nanyang Technological University, Singapore, 2000.
- [6] Asim Kaygusuz, Baris Baykant Alagoz, Murat Akcin, Cemal Keles , Abdulkarim Karabiber, Ozan Gul "Monte Carlo Simulation-Based Planning Method For Overload Safe Electrical Power Systems," Inonu University, Bingol University, Department of Electrical and Electronics Engineering, Turkey Journal of Electrical Engineering.
- [7] A. Sankarakrishnan R. Billinton "Effective Techniques For Reliability Worth Assessment In Composite Power System Networks Using Monte Carlo Simulation", Power Systems Research Group University of Saskatchewan Saskatoon, Canada, IEEE Transactions on Power Systems, Vol. 11, No. 3, August 1996
- [8] Lovleen gupta, Nittin Narang, Thesis on "Composite System Reliability Evaluation", power systems and electric drives, Tharapur University, 2009.
- [9] R. Billinton, S. Kumar, N. Chowdhury, K. Chu, K. Debnath, L. Goel, E. Khan, P. Kos, G. Nourbakhsh, J. Oteng-Adjei, "A Reliability Test System For Educational Purposes - Basic Data," Power Systems Research Group University of Saskatchewan Saskatoon, Saskatchewan CANADA, IEEE Transactions on Power Systems, Vol. 4, No. 3, August 1989.
- [10] Dr. Attila Csenki, "The Number of Working Periods of a Repairable Markov System during a Finite Time Interval", Aston University; Aston Triangle; Birmingham, IEEE Transactions on Reliability, Vol. 43, NO. 1, March 1994.

- [11] Wenchen LI, Lu Sun, Weimei Zou, Chunqing Luo, “Power System Reliability Analysis of System Based on PSASP and Fault Enumeration Method and Applications”, China Electric Power Research Institute-China, China International Conference on Electricity Distribution (CICED), Shenzhen, 23-26 Sep. 2014.
- [12] Aleksandamr. Stankovi, Edwina . Marengo “A Dynamic Characterization of Power System Harmonics Using Markov Chains”, Northeastern University Boston, IEEE Transactions on Power Systems, Vol. 13, No. 2, May 1998
- [13] Qinru Qiu, Massoud Pedram, Qing Wu, “Stochastic Modeling of a Power-Managed System—Construction and Optimization”, IEEE Transactions On Computer-Aided Design Of Integrated Circuits And Systems, VOL. 20, NO. 10, OCTOBER 2001

IJERGS