

Improving spectral efficiency of short-distance Er^{3+} modified optical fiber amplifiers by implementing acousto-optic tunable filters

Akmal M. Inogamov

Department of Devices and Radio Communication Systems, Tashkent University of Information Technologies, Uzbekistan

E-mail: inogamov-akmal@yandex.ru

Abstract— The purpose of this article is description the main experimental results conducted to improve the spectral characteristics of short-distance erbium doped optical amplifiers (SD-EDFA) created on the basis of high erbium concentrated modified optical mediums. Nowadays, the problem of improving spectral characteristics of optical amplifiers (EDFA) is a topical problem. Optical amplifiers which have linearized spectral characteristics and low level automatic spontaneous emission (ASE) could increase the transmission length of DWDM system. Previous experiments were demonstrated that SD-EDFA amplifiers have a low level of ASE and NF (noise-figure), but due to the high concentration of active erbium ions (10^{20} - 10^{21} cm^{-3}) the light amplification characteristics SD-EDFA amplifiers are nonlinear. Nonlinear spectral characteristics of SD-EDFA amplifiers introduce additional losses and noises for wavelength multiplexed signal and reduce the optical-signal noise ratio (OSNR) of common DWDM system. Thus, the main objective of a study is identifying linearization opportunities the spectral characteristics of SD-EDFA amplifiers. To linearize the amplified optical signals at the output of optical amplifiers were implemented acousto-optic tunable filters based on TeO_2 . Revealed that, acousto-optic tunable filters with cross-pin design and with embedded scheme of modulation transverse polarized modes can effectively linearized spectral components with accuracy 0,2 nm grid in 1200-2500 nm range. The article also presents the results of experimental studies simultaneous usage of acousto-optic tunable filters with short-distance optical amplifiers.

Keywords— Acousto-optic tunable filter, erbium doped fiber, rare-earth element, automatic spontaneous emission, gain, power, optic signal, DWDM, optical-signal noise ratio.

INTRODUCTION

Day by day optical fiber communication networks cover more and more areas. Currently, research and development the new generation of optical amplifiers which can effective amplify the optical signals is a topical problem. Respectively, the existing optical amplifiers amplification parameters for effective gaining of the optical signal without 3R-regeneration are imperfect.

The main disadvantages of these amplifiers are a high value of the noise figure and nonlinearity of spectral characteristics. So, the high value of ASE and NF (noise-figure) negatively affect to the level of OSNR in the fiber-optic communication system. In general, the level of EDFA amplifier noise figure directly depends on automatic spontaneous emission (ASE) level of erbium ions (Er^{3+}) in the alloyed region of the optical fiber. The length of erbium doped fiber in the modern optical amplifiers reaches from 3 to 30m [1]. To reduce the noises occurring due to ASE, in our laboratory were developed short-distance optical fiber amplifiers [2]. These amplifiers have a short length of alloyed area and the value of the alloyed active section varying from 3 to 10 cm. The short length of the active fiber gives a small value of the noise factor and increases the DWDM system OSNR accordingly. The amplification commensurate with modern fiber-optic amplifiers is achieved by creating high concentrated modified optical mediums, with extremely high active erbium ions in a pumped area (10^{20} - 10^{21} cm^{-3}) [3].

Table 1 shows the comparative characteristics of modern optical amplifiers (EDFA) and short-distance erbium doped fiber amplifier (SD-EDFA) created on base high concentrated modified optical mediums [4].

Table 1. EDFA and SD-EDFA main parameters

Parameters/type	EDFA	SD-EDFA
Amplification medium length , L	2 m	3 cm
Maximum gain, G	16 dB	10 dB
Amplifier sensitivity, P_{min}	-25 dBm	- 45dBm
Noise-figure, NF	5-6 dBm	1-2 dBm

It is well known that the systems with dense wavelength division multiplexing (DWDM) with a frequency grid 0,4nm (ITU-T G.694.1) are sensitive to the slightest non-uniformities in the spectral characteristic of the optical amplifier, especially in the case of short-distance optical amplifiers (SD-EDFA) [5].

SD-EDFA amplifiers, despite the lowest noise-figure level have a nonlinear amplification over the whole amplification bandwidth and the amplified optical signal groups will have a nonlinear gain with each other.

This effect is explained by the fact that, SD-EDFA amplifiers have a several simultaneous amplifying centers due to the extremely high concentration of active rare earth ions of erbium (Er^{3+}) [6]. Fig. 1 demonstrates the comparative spectral characteristics of modern EDFA and SD-EDFA amplifiers.

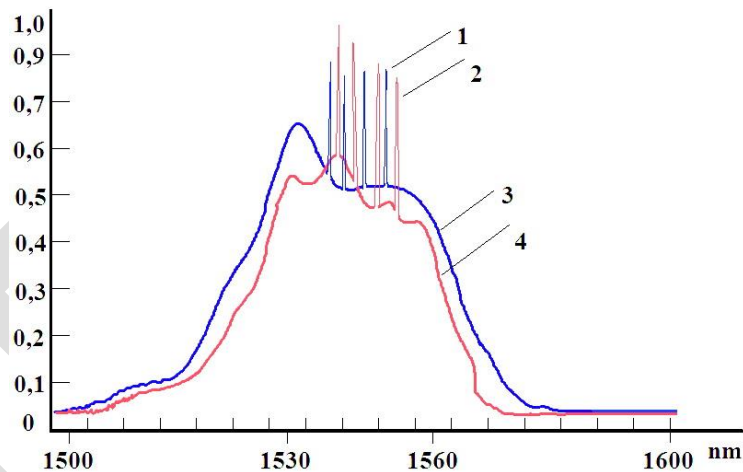

Fig. 1. Comparative spectral characteristics of EDFA and SD-EDFA in amplification mode

1 – Amplified WDM signal by EDFA; 2 – amplified WDM signal by SD-EDFA; 3 – ASE level of EDFA; 4 – ASE level of SD-EDFA.

The input of optical amplifier is fed by the sequentially optical signals ($\lambda = 1540, 1542, 1544$ and 1546 nm) with different wavelengths and detecting by OSA (Optical Spectrum Analyzer). As a result of spectral characteristics summation of the lasers we obtaining a simulated DWDM signal. According to the Fig. 1, in spite of the low-noise ratio and low level noise-figure, due to the nonlinear amplification, the SD-EDFA amplifiers becomes not effective for DWDM systems which have the maximum channel capacity 80 channels or channel spacing 50GHz [7].

The results of the experiments oriented to solve this problem and improve the spectral efficiency of SD-EDFA amplifiers further described.

DESCRIPTION OF EXPERIMENTAL METHOD

To linearize the output signal from the optical amplifiers acousto-optic tunable (AOTF) filters could be used. AOTF widely use in modern fiber-optic communication systems to isolate narrowband signals from a common broadband spectrum and perform a wavelengths selective switching in the ROADM (Reconfigurable optical add/drop multiplexors) systems [8].

Acousto-optic tunable filters are solid-state optical filters, which work on acousto-optic diffraction principle in an anisotropic medium. The main advantages of such filters is a wide range, quick adjustment by changing the frequency of the applied RF signal, a large angular aperture while maintaining high spectral resolution, the intensity and the possibility of modulating selected wavelength [9]. Based on these features, acousto-optic filters can be use for adjusting and changing the intensity level of spectral multiplexed optical signals. For the experiment were chosen acousto-optic tunable filter based on the TeO_2 (Tellurium dioxide) crystal [10].

Filters on TeO_2 crystals have 4 operating ranges. The third range is from 1200 to 2500 nm. This range meets the requirements of modern DWDM systems. Currently all DWDM systems operate in the third window transparency ~ 1550 nm [11]. Fig. 2 shows a block diagram of equipments interconnection on which the measurements were spent.

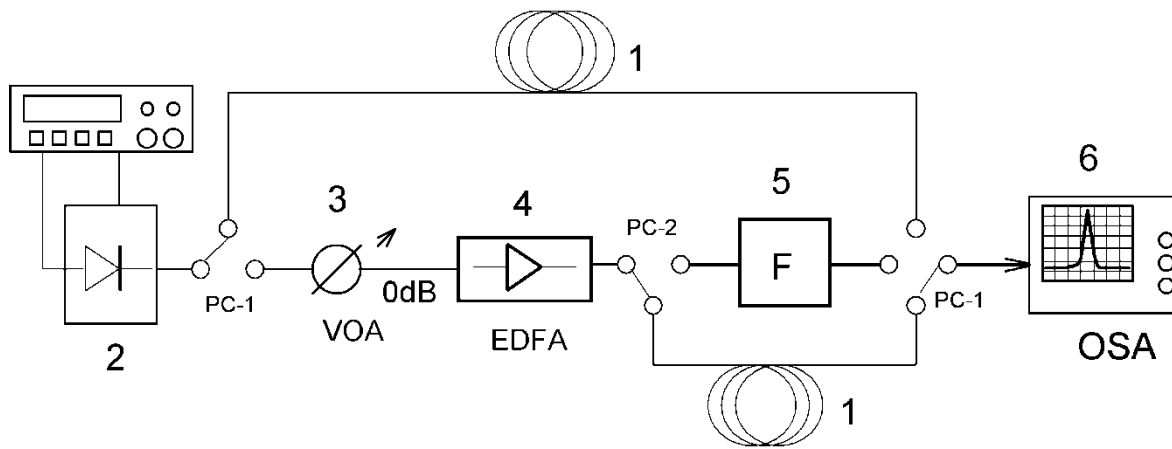

Fig. 2. Block diagram of equipments interconnections

1 – LEAF – G.655 standard optical fiber; 2 – semiconductor DFB-laser; 3 – variable optical attenuator; 4 – SD-EDFA (EDFA); 5 – AOTF on base TeO_2 ; 6 – optical spectrum analyzer; PC-1, 2, 3 – optical patch-cord and pigtails connection.

Generated by a semiconductor laser (2), optical signal consist of a several transverse modes. Through the microlens the optical signals are entering in to the single-mode fiber (1). Next, optical signals are passing through the amplifier cascade (4). Usage of acousto-optic rebuild filters (5) with a cross-pin electrode configuration produces the transformation of transverse laser modes up to 99.9% and receives filtering wavelengths of laser radiation in the range of the third transparency window ~ 1550 nm. The width of the optical waveguide is 6-7 mm and a TeO_2 crystal dimension is around 20-40 mm.

EXPERIMENTAL RESULTS AND DISCUSSION

Fig. 3 illustrates optical signals (WDM simulated signals) at the input from a DFB - semiconductor laser with a wavelength $\lambda = 1540, 1542, 1544$ and 1546 nm.

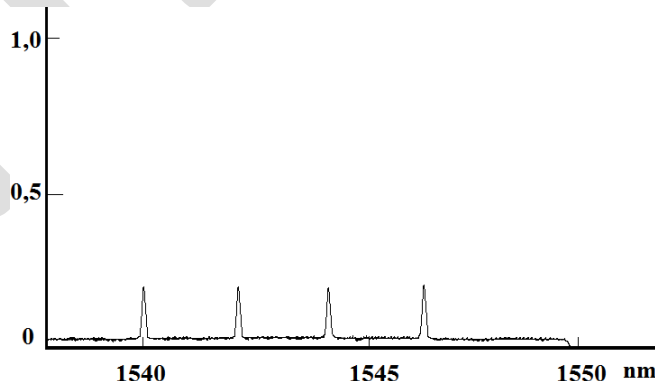

Fig. 3. Optical spectrum analyzer indication at the position (SD-EDFA-off, AOTF - off)

According to the picture at the disabled optical amplifier and deactivated acousto-optic filter, there is not amplified laser peaks at wavelengths corresponding to the input signal. In this experiment the variable optical attenuator (VOA) is set to the threshold power ($P_{TH} = 0\text{dB}$). The path lengths of the optical signals are equal to the length of the optical fiber. In the experiment was used optical fiber LEAF - G.655 standard. Optical fiber length $L = 10\text{ m}$, the attenuation coefficient of the optical fiber is equal to $\alpha = 0,25\text{ dB/km}$. Detecting optical power without amplification at the optical spectrum analyzer input is equal to $(-0,4\text{dBm})$.

At the second stage of an experiment, as shown in Fig. 2, the SD-EDFA amplifier connecting in-series to the line. Fig. 4 shows the spectral characteristics of optical signals after interaction with the SD-EDFA amplifier.

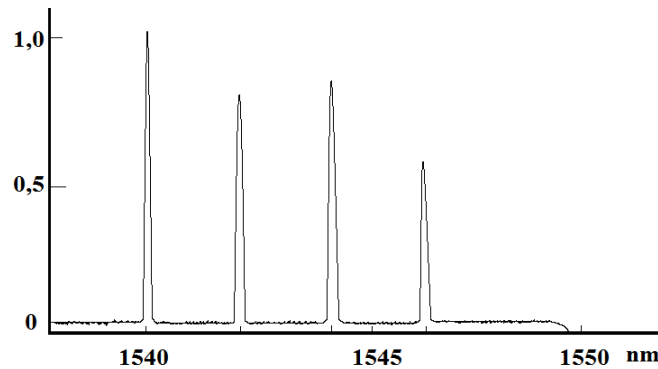

Fig. 4. Optical spectrum analyzer indication at the position (SD-EDFA-on, AOTF - off)

When SD-EDFA amplifier was turned on, the average optical power for each lasers beam were $\sim 12,5\text{dBm}$. Amplification of the optical signal to $12,5\text{dBm}$ achieved by creating a population inversion in the erbium doped region of the modified optical fiber. Next operation is measuring the ASE of SD-EDFA without input laser signals when acousto-optic tunable filter in-series turning on in to the line [11]. Fig. 5 represents the smoothing spectral characteristics of optical amplifier due to the modulation of surface waves in the acousto-optic filter.

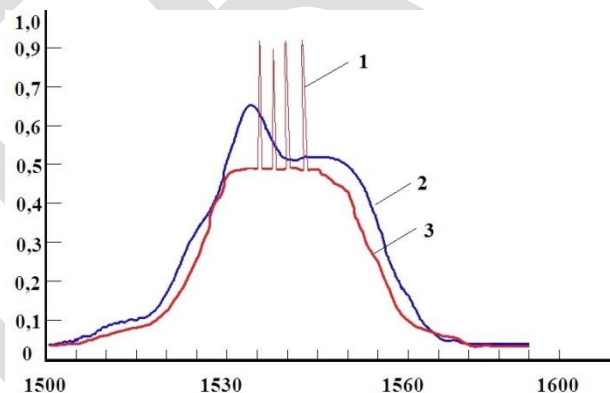

Fig. 5. SD-EDFA ASE curvature smoothing and WDM signals amplification.

1 – WDM signals amplification by the linearized AOTF spectrum; 2 – EDFA ASE spectrum without linearization; 3 – SD-EDFA linearized spectrum after passing through AOTF.

After smoothing the curvature of ASE, signal source is turned on and on smoothed area (C-Band) the DWDM optical signal is amplifying.

Table 2 shows the results of using the SD-EDFA amplifiers in different modes of input power. Using an optical attenuator VOA at the input of optical amplifier is supplied optical signal with different values of input power. Simultaneous using of the acousto-optic tunable filter allows linearization of the spectral characteristics of the optical amplifier over the entire working spectral range (1530 - 1465 nm) [12]. The optical signal input power range is from -30 to 0dB [13]. The experiment was carried out for different values of the input power $P_{IN}=0, -10, -20, -30\text{dB}$. In this case, the pump power optical amplifier remained on constant value $P_{PUMP}=50\text{mW}$. Short-distance optical amplifiers due to the high concentration of active rare earth ions (Er^{3+}) are working in the saturation mode at the

level below 1dB [14]. Therefore, the mark is 0dB bordering zone data amplifiers, i.e. further increase of input power will not change the level of ASE. The table 2 below and Fig. 6, 7, 8 represent spent measurements.

Table 2. SD-EDFA amplification measurements for input power ($P_{IN}=0, -10, -20, -30\text{dBm}$)

	SD-EDFA – off, AOTF - off				SD-EDFA – on, AOTF - off				SD-EDFA – on, AOTF - on			
$P_{IN}=0\text{dB}$	-0,1	-0,11	-0,1	-0,1	1	0,5	-1	-3	0,2	0,3	0,1	0
$P_{IN}=-10\text{dB}$	-10,09	-10,05	-10,02	-10,1	2	1,5	0	-1	0	0,1	0,2	0
$P_{IN}=-20\text{dB}$	-21,09	-21,1	-21,1	-21,01	0	-1	-2,2	-5	-0,1	-0,2	-0,3	-0,1
$P_{IN}=-30\text{dB}$	-31,1	-31,05	-31,1	-31,09	-3	-4	-6	-7	-0,5	-0,6	-0,7	-0,5

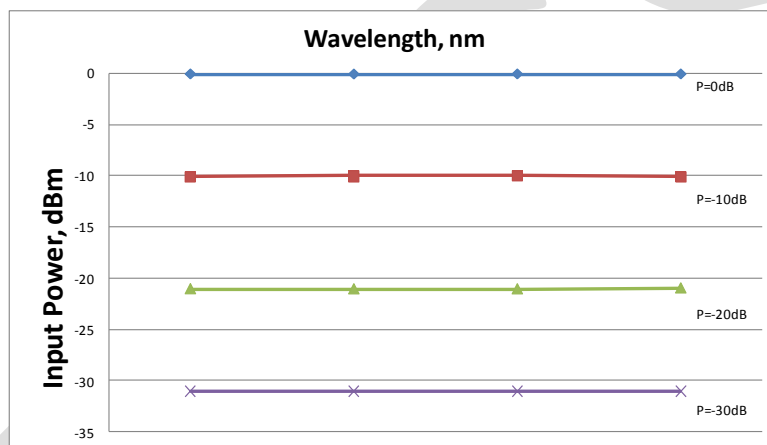

Fig. 6. Power detection at the SD-EDFA – off, AOTF – off ($\lambda = 1540, 1542, 1544$ and 1546 nm)

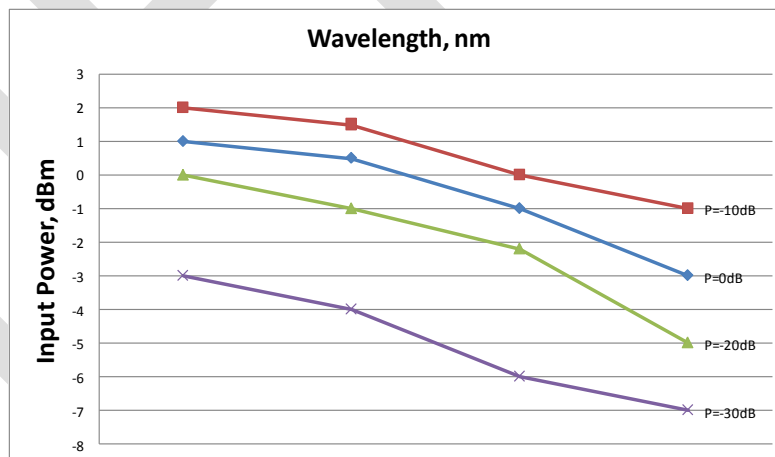

Fig. 7. Power detection at the SD-EDFA – on, AOTF – off ($\lambda = 1540, 1542, 1544$ and 1546 nm)

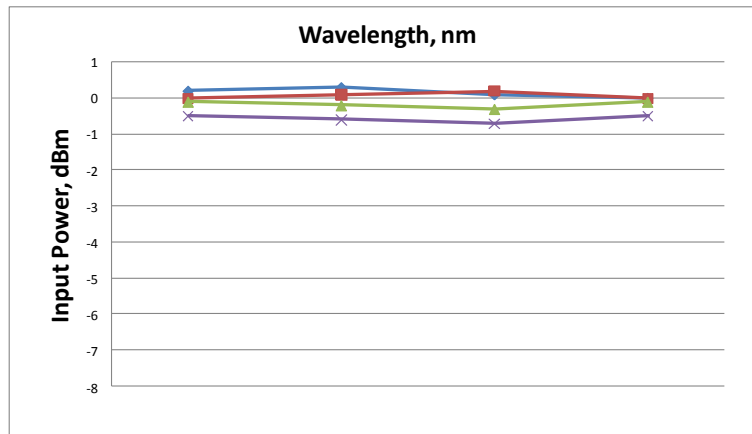

Fig. 8. Power detection at the SD-EDFA – on, AOTF – on ($\lambda = 1540, 1542, 1544$ and 1546 nm)

CONCLUSION

The possibility of linearization of the spectral characteristics SD-EDFA amplifiers with a small measure of the noise factor, gives an opportunity to improve OSNR fiber-optic communication lines. Consequently, this leads to an increase of the distance amplifying sections and organizing fiber optic communication assured. It should be added that the insertion loss of a single cascade acousto-optic filter does not exceed 0,2dB. The response time of the acousto-optic filter depends on the size and design of the filter. Mean time response of less than 50 μ s. Average power consumption acousto-optic filters varies 100 μ W [10]. The experiment found that the application of acousto-optic filters allows increasing the quality of the spectral characteristics of erbium doped optical amplifiers due to linearization peak spontaneous emission (ASE).

REFERENCES:

- [1] P. Shukla, K. Kaur, "Performance Analysis of EDFA for different Pumping Configurations at High Data Rate," International Journal of Engineering and Advanced Technology, vol. 2, no. 5, pp. 487 – 490, 2013.
- [2] A. Inogamov, T. Radjabov, "Modified thin-film fabrication method using vacuum thermal evaporation and vacuum synthesis: application to preparation of Er-doped fiber amplifiers," International Journal of Innovation and Applied Studies, vol. 5, no. 1, pp. 16 – 22, 2014.
- [3] P. Nandi, G. Jose, "Superfluorescence from Yb- and Yb-Er doped phosphotellurite glass fibres," Optical Fiber Technology, vol. 14, no. 4, pp. 275 – 280, 2008.
- [4] T. D. Radjabov, A. A. Simonov, A. M. Inogamov, "Application of vacuum evaporation for manufacturing fiber-optical modules and amplifiers," Vacuum Science and Technology, pp. 258 – 261, 2010.
- [5] Md. Shipon Ali, "The Challenges of Data Transmission toward Tbps Line rate in DWDM System for Long haul Transmission," International Journal of Future Generation Communication and Networking, vol.7, no.1, pp. 209 – 216, 2014.
- [6] G. R. Khan, "Analytical method for gain in erbium doped fiber amplifier with pump excited state absorption," Optical Fiber Technology, vol. 18, no. 6, pp. 421 – 424, 2012.
- [7] V. Mikhehashvili, G. Eisenstein, "Structural and electrical properties of electron beam gun evaporated Er₂O₃ insulator thin films," Journal of Applied Physics, vol. 95, no. 2, pp. 613-620, 2004.
- [8] Morgan D., Surface Acoustic Wave Filters: With Applications to Electronic Communications and Signal Processing, Amsterdam: Elsevier, pp. 157 – 182, 2007.
- [9] V. Volochinov, N. Polikarpova, "Collinear tunable acousto-optic tunable filters applying acoustically anisotropic materials tellurium dioxide," Molecular and Quantum Acoustic, vol. 24, pp. 225 – 235, 2003.
- [10] L. Wei, S. Yu-Nan, C. Fang and B. Long, "Feasibility of Non-Collinear TeO₂ Acoustic-Optic Tunable Filters Used in the Optical Communication," Chinese Physical Letters, vol. 24, no. 4, pp. 986 – 990, 2007.
- [11] H. Kim, S. Yun, H. Kim, N. Park, and B. Kim, "Actively gain-flattened erbium-doped fiber amplifier over 35nm using all-fiber acoustooptic tunable filters," IEEE Photonics Technology Letters, vol. 10, no. 6, pp. 790 – 792, 1998.
- [12] T. Radjabov, A. Inogamov, "Application of acoustic-optical rebuild filters for optimize the spectral characteristics of EDFA," International conference of Info-communications, vol. 2, no. 26, pp. 13-16, 2013.
- [13] J. Antonio-Lopez, A. Castillo-Guzman, D. May-Arrijoja, R. Selvas-Aguilar and P. LiKamWa, "Tunable multimode-interference bandpass fiber filter," Optics Letters, vol. 35, no. 3, pp. 324 – 326, 2010.
- [14] Agrawal G. P., *Fiber-Optic Communications Systems*, New York: John Wiley & Sons, Inc, pp. 652-653, 2002.