



Performance-based fire protection of office buildings: A case study based on the collapse of WTC 7

Robert Korol ^{a,*}, Frank Greening ^b, Paul Heerema ^a

^a Department of Civil Engineering, McMaster University, Hamilton, Ontario L8S 4L7, Canada

^b CTSNA Consulting, Kincardine, Ontario N2Z 2Y7, Canada

ABSTRACT

This article points out the benefits of employing a performance based analysis approach for ascertaining the likelihood that travelling fires in an office building could induce a localized failure that might trigger its collapse. The case study chosen is Building 7 of the World Trade Center complex. Based on the parametric study undertaken, our findings were that the fire-protected steel floor beam, identified as the initiator of the cascade of events that followed, could not have done so, virtually under any circumstance.

ARTICLE INFO

Article history:

Received 2 July 2015

Accepted 29 July 2015

Keywords:

Collapse initiation

Steel structures

Fire loadings

Fire protection

Thermal analysis

Heat release rates

1. Introduction

While the collapse of the WTC twin towers on 9/11 received the lion's share of publicity and, and rightly so, considering the thousands who lost their lives that day, the mystery of why the 47 storey steel framed building, WTC 7, that collapsed several hours later remains to this day a mystery in several respects. Indeed, the official National Institute of Standards and Technology (NIST) report on that collapse was finally made public some seven years later in August 2008 (NIST, 2008a). Despite a couple of fuel tanks in the lower part of the building, the fires that precipitated collapse were claimed to have been caused by incendiary debris that catapulted from a plummeting WTC 1, severing columns and breaking windows on the south face of #7 during its collapse. These flaming remnants then caused combustible materials within office areas to burn and spread from area to area, weakening structural members and causing thermal expansion of an identified floor beam claimed to have dislodged the end of a particular girder resulting in "walk-off" its column support. The analysis by NIST purportedly then caused a locally unsupported column to buckle, precipitating an array of failures that very

quickly cascaded into storey-by-storey collapses leading to global collapse of the entire structure.

Without laying blame on anyone, NIST attempted, through its strong working relationship with ASCE, to propose recommendations meant to ameliorate perceived weaknesses in building codes to avoid such tragedies from happening in future, with particular attention on ways to protect occupants and to preserve a structure's integrity when severe fires occur. This initiative resulted in NIST setting out 30 recommendations (NIST, 2008b) that ranged from developing "consensus standards and code provisions" to "academic, professional short-courses, and web-based training programs".

Since the collapse of WTC 7 represents the first time in history that a steel-framed building of significance succumbed to fire loadings alone, it has given rise to much discussion among those in structural engineering and architecture. A software package known as Fire Dynamics Simulator (FDS) was developed by NIST to incorporate the vast array of information that is needed to design or make predictions about an existing structure's safety when subjected to extreme fire loading events. However in either case, there are circumstances for which less sophistication is appropriate. A simplified

* Corresponding author. Tel.: +1-905-525-9140 ; Fax: +1-905-529-9688 ; E-mail address: korol@mcmaster.ca (R. Korol)

performance-based design (PBD) fire analysis, based on the laws of thermodynamics and structural engineering principles, able to include several parameters, and which examines specific details of a design may require such an approach, consistent with the time-temperature models such as described by Petterson et al. (1976). In our view, such an approach is appropriate with the initiation of the collapse of Building 7, to be examined in this paper.

2. Basic Principles for Passive Resistance to Fire Loads

For many decades, structural engineers relied solely upon fire resistance ratings to ascertain the passive protection needed for a steel frame structure, however, since 9/11, an alternative method known as Performance-Based Design (PBD) has evolved, with the objective being to enhance our understanding of fire events in buildings and to employ methods, as needed, to provide protection. Frater and Kleinfeldt (2001) provide very useful introductory material in this regard. Other important papers appear in the Journal of Fire Sciences, of which the recent forum article by Quintiere and Williams (2014) suggests that the FDS method employed by NIST is “weak” in support of its rationale for the collapse. However, before launching into our own PBD analysis in connection with Building 7’s collapse, a few basic principles and assumptions are presented as follows.

2.1. Heat energy release rate

When combustible materials burn in air, the heat release rate generated, Q_C , is expended both as that which causes a change in temperature in the gases themselves, known as sensible heat, Q_S , and radiant heat, Q_R , which directly causes heating of the adjacent surfaces that are exposed. As such, the heat generated from a prescribed amount of combustible material is given by Gray and Muller (1974) as:

$$Q_C = Q_S + Q_R \quad (1)$$

For typical office fires, Q_S , the sensible heat term, is mostly dissipated by hot exhaust combustion gases that involve three parameters, one of which is the chemical reaction gas mass combustion rate m_G , a parameter which brings into play the conversion of a combustible material into a variety of gases released in the process. The equation that is applicable is given by:

$$Q_S = m_G c_p \Delta T \quad (2)$$

where, c_p is the heat capacity of the combustion gases at constant pressure, and ΔT is the increase in the temperature of the combustion gases due to the fires from an initial temperature T_i to a higher temperature T_G .

The quantity m_G may be derived from a consideration of the combustible material consumption rate, modified by the addition of oxygen. Such materials generally consist of wood products or one form or other of plastic compounds. A common type of the latter may be represented by polystyrene, while the former is generally

chemically equivalent to cellulose. In the case of polystyrene, its complete combustion in an oxygen environment is governed by the chemical formula;

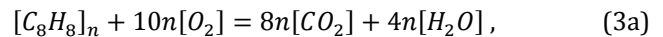

where n denotes the number of moles associated with each compound, while the reaction of burning cellulose is governed by

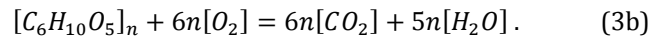

The combustion of 1 kg of polystyrene therefore requires 3 kg of oxygen (Eq. (3a)), while that for 1 kg of cellulose necessitates 1.19 kg of O_2 (Eq. (3b)).

However, since we are dealing with combustion reactions in air, each mole of O_2 supplied to the fire is accompanied by 3.76 moles of N_2 , thus resulting in a reaction involving 5.1 kg of air per kg of the wood equivalent (cellulose). Since each kilogram of fuel adds 1 kg of mass to the reaction products, we have a total of 6.1 kg of combustion gases released per kg of cellulose burned. In the case of polystyrene, a similar mass balance computation will show that 14 kg of air is required for each kg of the plastic equivalent material resulting in 15 kg of combustion gases produced. Of course, we do not know the precise composition of the combustible materials in typical office building fires. Taking an average between the two materials considered, we may assume that the combustion of one kilogram of a wide variety of fuels is accompanied by a total release of about 10 kg of “exhaust” gases consisting of a mixture of CO_2 , H_2O and N_2 . It is reasonable to assume that for typical combustion gas mixtures, an average value for c_p of 1.2 kJ/kg°C is appropriate since the heat capacity for the above-mentioned gases is close to 1 kJ/kg°C, while that of water vapor is much higher at about 1.9 kJ/kg°C. It is important to mention that incomplete combustion may involve other gases that could be classified as toxic such as carbon monoxide and would therefore dissipate more heat than that which we have described above. Our primary objective, of course, is to utilize an expression for Q_R that will allow computation of the temperature of the steel floor beam alleged to have triggered collapse as a function of fire duration.

2.2. Radiant heat release rate

As noted in Eq. (1), Q_R can be determined once Q_C and Q_S have been identified. However, each of Q_R and Q_S depends on the temperature of the gases emanating from the flames within the prescribed compartments that are producing hot fires. Assuming that the combustibles are located below the partition height of typical cubicles, i.e. about $\frac{1}{2}$ the floor-to-ceiling height, it is reasonable to conceive of the flames, on average reached that level, as noted in Fig. 1(a). Noted also, is a conceptual steel beam at the ceiling level above the work station. To determine the temperature at the flame tip interface, T_G , it is convenient to employ the Stefan-Boltzmann equation (Gray and Muller, 2008) that expresses the radiant heat release rate, Q_R , due to burning materials in a compartment fire, noted as:

$$Q_R = \epsilon A \sigma T_G^4, \tag{4}$$

where ϵ is the emissivity of the gas, A is the surface area of hot gas to air interface (assumed at the top of a partition wall), σ is the Stefan-Boltzmann constant and T_G is the absolute temperature of the hot gases in degrees Kelvin. Since $T_G - T_i$ is also equal to ΔT in Eq. (2), it follows that T_G can be computed if the other parameters in Eqs. (1) and (4) are specified. It will be assumed that T_i is room temperature of 20°C, i.e. 293 K, with other values being: $\sigma = 5.67 \times 10^{-8} \text{ W/m}^2\text{K}^4$, $\epsilon = 0.7$ (Gray and Muller, 1974) while A is expressed in m^2 .

Substituting the above into Eq. (1) results in the following quartic algebraic equation

$$\epsilon A \sigma T_G^4 + m_G c_p T_G = Q_C + m_G c_p T_i. \tag{5}$$

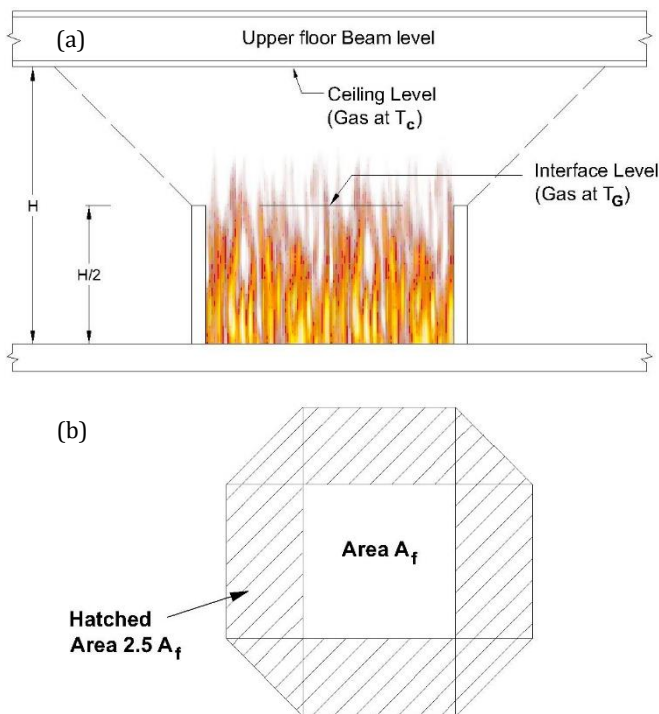

Fig. 1. Work area enclosure and surroundings (a) Conceived fires and impacted local domain (b) Footprints of floor and heated ceiling areas.

Once Q_C is selected, we can then solve for T_C . In that regard, we need both an estimate of the heat capacity of the combustible materials in question, and an estimate of the mass consumption rate during typical office fires in order to compute T_C . For the WTC fires, NIST estimated a duration of 25 minutes as being a reasonable estimate for a burn rate period (NIST, 2008c). Fundamental to computing a maximum temperature for a particular structural member is an estimate of the fuel load that is either typical of office buildings, or which has been established from earlier studies. Our focus is to employ the simple approach laid out through the set of equations quoted above to the floor beam that is claimed to have expanded sufficiently to cause column 79 at the 13th floor

of WTC 7 to lose lateral support and hence trigger the collapse of the entire building. A sketch of the subject connection detail that is the focus of our case study is shown in Fig. 2 (Frankel Steel Limited, 1985a).

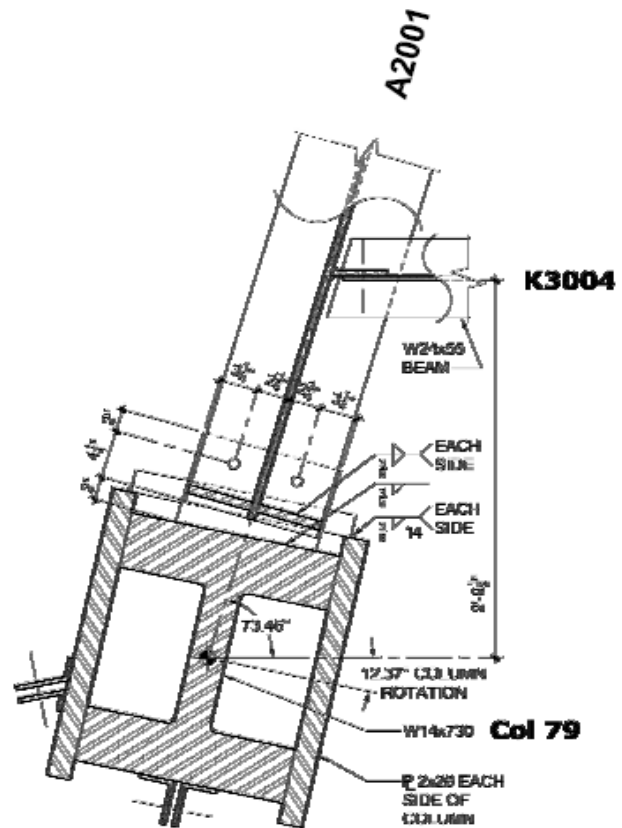

Fig. 2. Plan view of member intersection at column 79 (Data from Frankel Steel Limited, 1985b).

If we adopt the NIST heat of combustion average value of 16 MJ/kg, a value that virtually coincides with that of Feasey and Buchanan (2002) and the 25 minute burn period noted above, 22.5 kg/m² will generate a heat release rate, Q_C of 240 KW, the assumption being that the mass of combustible materials would diminish at a constant rate of 0.015 kg/sec. This appears to be a reasonable estimate, as the assumed amount of wood and plastic materials equivalent per m² is often cited as 20 kg/m² (typical for office buildings). On the other hand, this estimate, although reasonable for most office buildings, may not account for the unusual situation wherein excessively high fuel loading may result in some compartments versus that in others. Indeed, the NIST report indicates a loading of 32 kg/m² to be appropriate, a case to be examined, together with an even higher value of 45 kg/m². This latter estimate is included to account for the case of traveling fires, shown to augment the maximum temperature at a specific location by virtue of “far afield” fires (Jonsdottir et al., 2010). The heat release rates for these two fuel loadings are 341.3 and 480 KW respectively.

For each fuel loading, we will undertake an array of analyses for a 16.2 m (53 foot) long W24x55 floor beam, an end shown in Fig. 2, is alleged to have triggered the cascade of failures and noted in Frankel Steel’s erection

drawing as K3004 (Frankel Steel Limited, 1985b). These will include unprotected steel cases, and three thicknesses of sprayed-on fire resisting material (SFRM), 13, 20 and 40 mm, representing NIST’s estimate, an intermediate value, and 2 hours of fire protection (Jonsdottir et al., 2010) respectively, when subjected to the standard fire curve. The aim of such protection is to limit the maximum steel temperature from exceeding the critical value of 620°C (893°Kelvin), deemed to weaken such a member to the point of failure (Jowsey and Scott, 2014).

2.3. Combustion gas temperatures

As noted earlier, the hot gas temperatures, generated at the interface of the zones above and below the cubicle partition level (Fig. 1(a)) can be determined by solving Eq. (5). The results obtained are as follows: 22.5 kg/m² gives $T_G = 1188^\circ\text{K}$; 32 kg/m² gives $T_G = 1249^\circ\text{K}$, and 45 kg/m² results in a temperature of 1306°K, based on a constant heat release rate during a 25 minute period of combustion.

3. Ceiling Room Temperatures

The science of gas dynamics, fluid motion and heat transfer mechanisms indeed constitute a complex subject as they relate to burning fires in any environment. In the case of square-shaped cubicle-style compartments, we will assume that the heat generated from burning combustibles disperses outwards above such office enclosures at 45 degrees as noted in Fig. 1, with the result that the heat affected ceiling zone, A_c is 3.5 times the floor area, A_f , assumed to be square and of size H by H . This value is based on a 1/2 partition to ceiling height ratio, with triangles connecting the off-set rectangles at the corners of a rectangular office layout as noted in the figure. We further assume that the heat generated at the flame interface, A_f , is then uniformly spread out over that cubicle’s heat affected ceiling area, A_c .

However, if several work stations are placed back-to-back, the ceiling area footprint, A_c , is reduced relative to A_f due to fanned overlapping of impacted ceiling areas. So, for example, an array of three aligned cubicles results in $A_c/A_f = 2.67$, while for five, the value is 2.4. In the case of WTC 7, it seems reasonable to assume that material in 3 work stations, aligned with the floor beam K3004 might have been burning intensely simultaneously. If we assume, therefore, that the radiated heat, Q_R , is fully absorbed by the ceiling, its temperature, T_c , based on Eq. (4) is then computed as $T_c/[4\sqrt{(A_c/A_f)}] = T_G/1.278$. So, for the three fuel loadings noted above, the 22.5 kg/m² case results in a ceiling temperature, T_c , of 930°K, the 32 kg/m² case gives a value of 977°K, while 45 kg/m² has a computed value of 1022°K. These computed temperatures provide an estimate of the temperatures that the structural members would experience for fires generating a constant heat release rate over a period of 25 minutes, after which burn out is presumed in a prescribed location. The steps to follow are the computation of steel temperatures of K3004 over time, followed by a determination of that member’s elongation at the end of the burn period.

4. Unprotected Steel

In the case of heating of unprotected steel members, the following incremental equation is applicable (Jonsdottir et al., 2010):

$$\Delta T_S = \frac{F}{V} \frac{\Delta T}{\rho_S c_S} \{h_c(T_C - T_S) + \sigma \epsilon (T_C^4 - T_S^4)\}, \quad (6)$$

in which T_S represents the steel’s temperature at time t due to a fire, the temperature of which at the level of the ceiling is T_C , while the other quantities are defined as:

F/V , the member’s section factor, computed for top flange embedment in floor slab concrete = 103 m⁻¹ (W 24x 55 floor beam) represents an average mid-depth of the member, while ρ_S is the density of steel (7820 kg/m³), c_S is its specific heat (460 J/kg K, where K being temperature in Kelvin), while h_c is the convective heat transfer coefficient (7 W/m² K (Oetelaar and Johnston, 2012)). The factors σ and ϵ are the Stefan-Boltzmann and emissivity constants respectively, having values of 5.67x10⁻⁸ W/m² K⁴ and 0.7, noted earlier. In calculations to follow, $h_c(T_C - T_S)$ was much smaller than the $\sigma \epsilon (T_C^4 - T_S^4)$ term, but was included nonetheless for completeness.

4.1. Fuel loading = 22.5 kg/m²

This is the fuel loading case which most closely adheres to standards of combustible materials in office building compartments. Since the ceiling gas temperature was estimated to be 930°K, a time step of 1 minute (60 sec), following commencement of the fire, results in ΔT_{S1} to compute as 58.2 degrees (K or C). The steel temperature at the beginning of the next one minute step is therefore 351.2°K and results in ΔT_{S2} calculated to be 56.9°K. Finally, at the end of the fire period, ΔT_{S25} computes as 2.1°K, with the last time step of 60 sec. resulting in a final steel temperature of 925°K, or very near to the temperature of the ceiling gases. A plot of the steel temperature-time curve is shown in Fig. 3, and represents the lowest one (22.5 kg/m²).

4.2. Fuel loading = 32 kg/m²

This is the case that NIST deemed to be the basis for their fire dynamics simulator (FDS) program. Since the burn time remains the same as in the previous case, i.e. 25 minutes, a higher ceiling exposure temperature was expected, and computed to be 977°K. A similar pattern of temperature steps resulted from calculations, with T_S computed to be 975.9°K. Its values are plotted in the figure as curve 32 kg/m².

4.3. Fuel loading = 45 kg/m²

We recognize that there are unusual circumstances in which moveable materials may be temporarily stored in certain areas of a building during renovations, repairs or for operational reasons and hence we doubled 22.5 kg scenario’s value for such a possibility. In this case, $T_c = 1022^\circ\text{K}$, with the maximum steel temperature reaching

1020°K. The uppermost curve in Fig. 3 shows a plot of this case. The final steel temperature for all three scenarios, i.e. between 650 and 750°C, exceeds the critical temperature of 620°C. As such, the computed carrying capacity of a given unprotected steel member would be

exceeded and would likely cause a floor beam or girder to fail. A weakness in a connection detail, i.e. the way in which a member is joined to another, is oftentimes the reason for a localized failure and will be addressed subsequently.

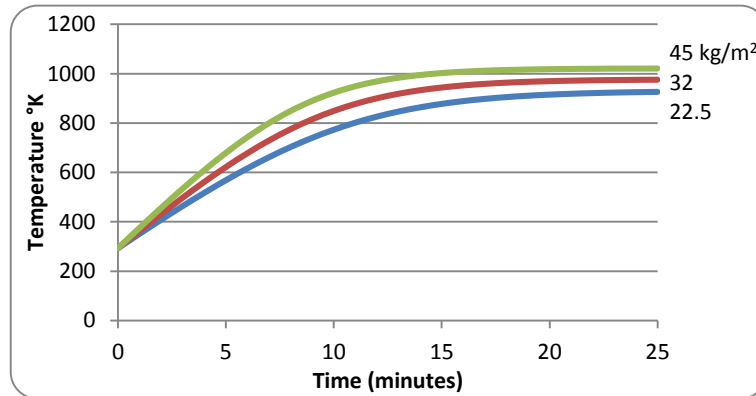

Fig. 3. Unprotected steel for a 25 minute fire.

5. Protected Steel

To protect steel framed buildings and their occupants from the devastating effects of a major fire, the standard procedure for design is to provide fire proofing material in accordance with prescriptive code requirements. Such protection was apparently applied to all structural members in WTC 7 and as such, the heating of the earlier identified floor beam is analyzed employing three thicknesses of SFRM (Sprayed-on Fire Resisting Material). For steel members that are provided with fire protection, the governing equation as noted by Jonsdottir et al. (2010) is:

$$\Delta T_s = \frac{F}{v d_i} \Delta t k_i (T_c - T_s) / \{ \rho_s c_s + d_i \rho_i c_i F / 2V \}, \quad (7)$$

where k_i is the thermal conductivity of the insulation, d_i its thickness, ρ_i the density, and c_i its specific heat. Appropriate values for low density spray type fire proofing as noted in the Steel Design Guide of AISC (Ruddy et al., 2002), were adopted in our computations as, $k_i = 0.135$ W/(m°K), $\rho_i = 293$ kg/m³, and $c_i = 754$ J/(kg°K), while thicknesses offering a reasonable range of estimates are noted as, $d_i = 13, 20$ and 40 mm, respectively. As noted for the unprotected steel cases, those scenarios pertaining to protected steel assumed a constant high intensity 25 minute burn period. Note that the same step-by-step procedure noted for the unprotected steel scenarios was utilized for the same fuel load cases noted in the previous section. Fig. 4 shows the plotted temperature-time results for the three fuel loading and three insulation thickness cases noted above while Table 1 summarizes the peak temperature values of the floor beam after a 25 minute burn period.

5.1. Fuel loading = 22.5 kg/m², $T_c = 930^\circ\text{K}$

In the case of the 13 mm SFRM scenario, it was found from Eq. (7) that the steel temperature, T_{S25} was 518°K after 25 minutes of a constant heat release rate from

burning combustibles of 240 KW/m². When 20 mm of SFRM is employed, the steel temperature T_{S25} is reduced to 447°K, while the 40 mm thickness case was only 370°K. This latter circumstance appears to be consistent with the prescriptive standard for floor assemblies at the time that WTC 7 was constructed, i.e. at least a 2 hour fire rating (Jonsdottir et al., 2010). Clearly, such a temperature (97°C) would not pose a threat to a floor beam's ability to carry design dead and live loadings.

5.2. Fuel loading = 32 kg/m², $T_c = 977^\circ\text{K}$

These cases appear to correspond to the fuel loading and burn time duration assumptions made in the NIST report (NIST, 2012). When 13 mm of SFRM is employed, the floor beam's average temperature gradually rises as shown in Fig. 4(b), reaching a maximum value of 535°K at the end of the 25 minute period. Increasing the protection to a thickness of 20 mm reduced the maximum temperature to 458°K while a value $d_i = 40$ mm lowered T_{S25} even further, i.e. down to 376°K. As noted, this case, and the other two noted in the sub-title are associated with a ceiling gas temperature of 977°K. The lowermost curve represents a most likely scenario, based on NIST information, assuming, of course, that the contractors and inspectors fulfilled their respective obligations during construction of the building.

5.3. Fuel loading = 45 kg/m², $T_c = 1022^\circ\text{K}$

As noted earlier, the cases that follow under this heading are very extreme in the nature of combustible loadings, and would only be plausible in the most extraordinary circumstances. For the case of 13 mm SFRM, it turns out that the steel floor beam would have experienced a maximum temperature of 551°K.

By increasing the thickness of SFRM to 20 and 40 mm respectively, the time-temperature calculations indicate maximum values of $T_s = T_{S25} = 469$ and 381°K respectively.

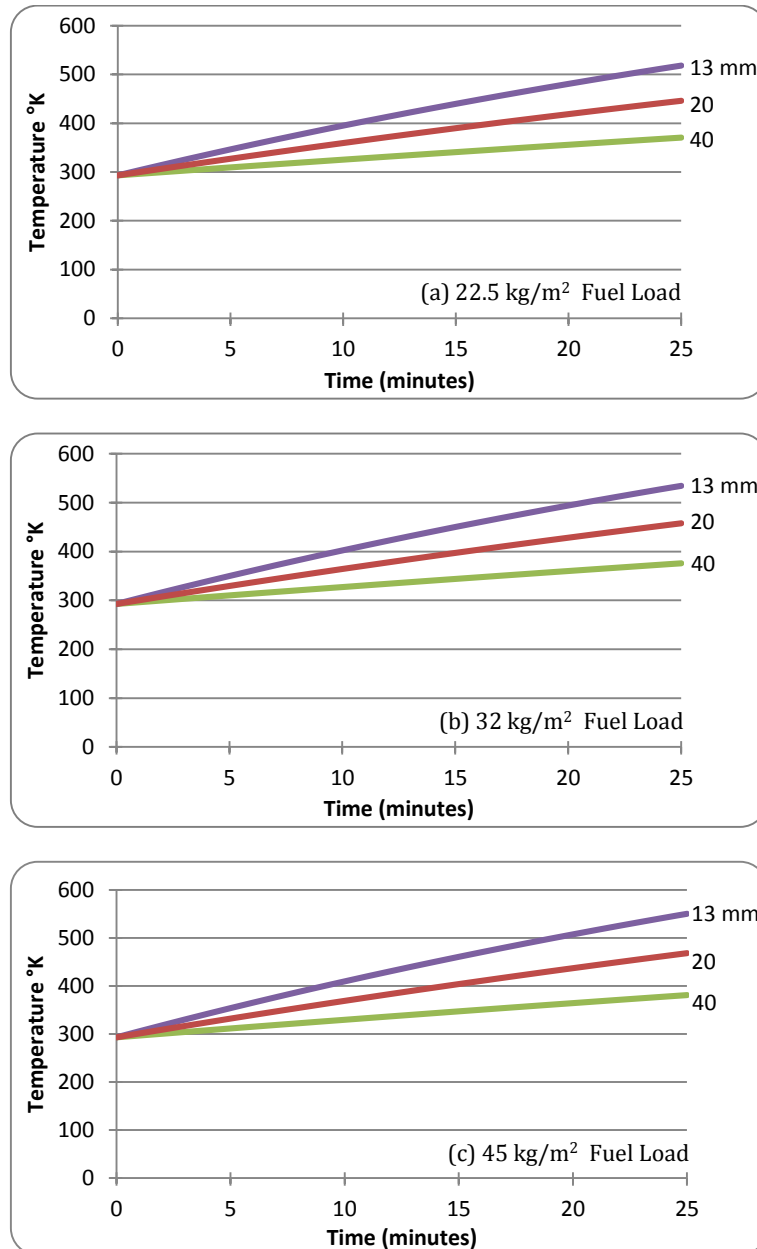

Fig. 4. SFRM protected steel (25 minute fire) - Results corresponding to $T_c = 977^\circ\text{K}$.

Table 1. 25 minute burn period (protected steel).

Fuel Load	22.5 kg/m ²			32 kg/m ²			45 kg/m ²		
T_G °K	1188								
T_c °K	930								
d_i (mm)	13	20	40	13	20	40	13	20	40
T_{S25} °K	518	447	370	535	458	376	551	469	381

A summary of the key information associated with the above analyses is presented in Table 1. Note an interesting observation with respect to the degree of insensitivity existing among all cases having a prescribed thickness of protection to the fuel loading parameter. For example, doubling the fuel load from 22.5 to 45 kg/m² for the 13 mm case, increases the temperature of the floor

beam by only 33°K, with an even more modest difference of 11°K obtained for 40 mm of insulation. If we make a supposition that NIST’s estimate of the fire duration of 25 minutes might actually have been on the low side, what increase or decrease would be expected in steel temperatures for the previous cases described above for the same fuel loadings? After all, the duration time was

based on outside- the- building viewing, and hence it's of interest to postulate the possibility that travelling fires may have resided in one area for 30 minutes rather than 25. Doing such an analysis is very simple if one employs a PBD analysis approach, rather than NIST's FDS method which is costly and time-consuming.

6. Sensitivity of Steel Temperatures to Fire Duration Time

For a given amount of combustible materials, there is a fixed amount of heat energy available for release to the environment. Since the heat release rate of combustible materials is dependent on several factors, such as, the ventilation factor, material composition, moisture content, and the average heat of combustion etc., it's of interest to investigate the effect of increasing the burn time while maintaining the fuel combustion capacity at 16 MJ/kg. Indeed, NIST was uncertain about the time of intense burning and mentions in their report (NIST, 2008a) an estimated burn period of 20 to 30 minutes. An increase from 25 to 30 minutes will therefore result in a reduced heat release rate which is proportional to the burn time period.

Repeating the calculations, then, for a 30 minute period results in somewhat lower values of interface of flame-to-air layer temperatures, T_G , and hence correspondingly reduced values of ceiling gas temperatures, T_C . For example, Q_C reduces from 240 KJ/sec to 200 KJ/sec, with the consequence that T_G in Eq. (5) reduces from 1188°K to 1155°K for the 22.5 kg/m² cases. Similar reductions occur for the 32 and 45 kg/m² scenarios. Subsequent T_C values have proportional reductions since the ceiling to floor area factor $(8/3)^{0.25}$ is the same for all cases.

Fig. 5 presents plots of time-steel temperature curves for identical cases utilized in Fig. 4. As such, the curves look very similar with final temperatures being at the maximum values at the end of the burn period, in this case, 30 minutes. A summary of the same data shown in Table 1 is given in Table 2 for the 30 minute scenarios. Note that all final temperatures are slightly higher than their counterparts in Table 1, indicating that duration time weighs more heavily than does gas temperature. We do not claim that this trend would extend out to an

infinite burn time, of course, since such a scenario would result in gas temperatures that would hardly exceed the ambient air temperature T_i .

7. Consequences of Steel Floor Beam Heating

Any of the scenarios above would have been theoretically possible, but many are highly unlikely. Those cases in which the steel is totally unprotected are meant to highlight the benefits achieved in providing insulating material that meets fire rating requirements. Since tenants in office buildings are generally free to utilize space in an unrestricted manner, it seems prudent to over-estimate, rather than to under-estimate fuel loads in fire engineering design. The 22.5 kg/m² fuel load is close to the norm in office buildings, the 32 value was judged by NIST to be more appropriate, and the 45 kg/m² value is clearly on the high side of what one would expect from the type of business and confidentiality attributes that are pertinent to tenancies involving finance and business, in general. In the case described, it is the 12th storey of WTC 7, i.e. beam K3004 on the 13th floor that was at issue.

It is well known that temperatures of structural steel in excess of about 893°K (620°C) will reduce member strength to a level below that which will support in-service loads. Hence, for the unprotected steel scenarios, Fig. 3 provides us with some insight into the times at which a hot fire consuming combustible materials would potentially result in failures. We noted earlier that such rates varied from a minimum of 0.015 kg/sec (22.5 kg/m²), to the maximum value of 0.03 kg/sec (45 kg/m²).

As observed from the figure, a potential failure state could be predicted after 18 minutes for the least amount of combustibles considered, 13 minutes for the middle case (32 kg/m²), and 10 minutes for the 45 kg/m² case (uppermost curve). Since the fires were presumed to last for 25 minutes, we may conclude that floor beam K3004 would have failed. However, we have confidence that SFRM was applied properly, with adequate thicknesses, either for a 2 hour fire rating, or at least a one hour. The question therefore is the extent to which elongation of the noted floor beam occurred, and thence whether such expansion could have triggered a cascading sequence of failures that resulted in the entire building's demise. This matter is explored in the next section.

Table 2. 30 minute burn period (protected steel).

Fuel Load	22.5 kg/m ²			32 kg/m ²			45 kg/m ²		
T_G °K	1155			1217			1275		
T_C °K	904			952			998		
d_i (mm)	13	20	40	13	20	40	13	20	40
T_{S25} °K	542	465	381	561	479	388	580	492	394

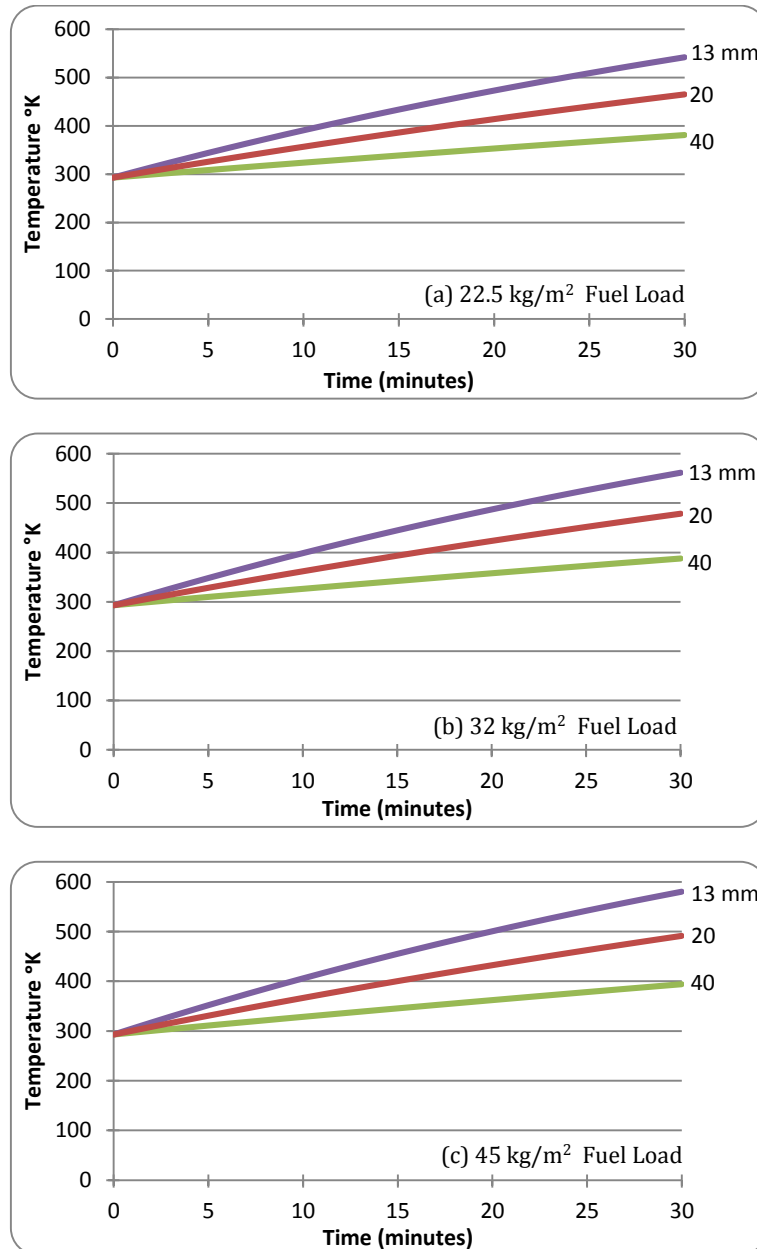

Fig. 5. SFRM protected steel (30 minute fire) - Results corresponding to $T_c = 952^\circ\text{K}$.

8. Protected Steel Floor Beam Elongation

Fig. 4 shows plots of computed steel temperature curves for fire exposure times ranging over the full 25 minute period. As expected, the steel temperature is highest when the fuel load is at 45 kg/m², and the SFRM is 13 mm in thickness. However, at 25 minutes, we only obtain a temperature of 551°K (278°C) for this case, which is well below the critical strength value. When we examine the results for a 30 minute fire, the maximum temperature is 580°K for 13 mm of SFRM. Again, the issue of strength is not in question, but it does raise the issue of what thermal elongation would one obtain in such a scenario?

If a structural member is free to elongate as a consequence of a temperature increase, its elongation is simply the product of α_T , the coefficient of linear expansion with the associated length and change in temperature. In the

case of the floor beam designated as K3004 in Frankel Steel's set of drawings, it was connected to girder A2001 (Fig. 2) that is alleged to have fallen off its shelf bearing plate support on column 79. The length of the floor beam was noted as being 53 feet (16.2 m). Roaming fires are unlikely to have the same intensity of temperature over that full length, but perhaps a half-length of 8.1 m would be a reasonable estimate. Assuming that displacement was essentially prevented at the perimeter column end yet unrestrained to move longitudinally at the girder end, the displacement would be $13.0 \times 10^{-6} \times 8.1 \times \Delta T$ °C (expressed in meters). For the case noted here for the 30 minute fire, and a 45 kg/m² fuel load $\Delta T = (580 - 293)^\circ\text{C} = 287^\circ\text{C}$, and so the floor beam elongation computes as 30.2 mm (1.19 in). By taking the unrealistic circumstance that the fire caused the entire length of the beam to reach 580°K (307°C) results in the elongation being 60.4 mm (2.38"), a displacement $\ll 152.4$ mm (6"), i.e.

the half width of the bearing plate shelf angle support. Clearly, the lateral displacement of girder A2001 then would not have been in jeopardy since walk-off would require the web of the girder reaching beyond the bearing plate's edge (Fig. 2). Indeed, if one computes the elongation value of the one end free (col.79) and the other fully restrained, and employs the temperature increase suggested by NIST of 400°C over the full length, an unrestrained elongation of 84 mm (3.3 in) results, which is again much less than the walk-off lateral displacement of the girder.

9. Discussion

The assumptions noted above, pertaining to the walk-off displacement of girder A2001, presupposed that it was free to displace laterally on its bearing seat support. In fact, displacements noted above, would have been further reduced by virtue of the composite action of the girder with the floor slab that involved $\frac{3}{4}$ " shear studs, spaced 18" along its length, as noted by Salvarinas (1986). It is well known by professional engineers who are involved in composite construction that shear studs rarely "shear off" when horizontal shear forces are activated by external loadings. They resist such forces by bending during conditions in which relative differences in horizontal displacements between a steel member and a concrete slab takes place, and as such are able to utilize their axial ultimate resistances. A similar situation exists for the floor beams. If a floor system employs composite construction, all major structural members in contact with a given floor slab will be connected with shear studs. If, as NIST indicated, such connectors were missing in girder A2001, such an omission might have been construed as a serious flaw in inspection. On the other hand, our calculations suggest that it matters not whether shear studs were or were not present – there would not have been walk-off in either instance.

For the girder A2001 to column 79 connection to even be a point of issue with respect to triggering collapse of WTC 7, it raises the question of whether such a detail is desirable or not. Fastening the girder by two bolts on its bottom flange to a welded seat support, seems to be inappropriate when large differential displacements are possible. It would appear to be more prudent to use a bearing seat support for erection purposes only, and employ double girder web angles, or equivalent, to secure that member to the column. Perhaps NIST might wish to recommend to steel structural code committees that for unusual forms of member layouts for floors (as was the case with WTC 7) a more robust form of connecting steel members to one another may be justified.

10. Conclusions

By applying the principles inherent in performance-based design to a localized area of a structure deemed to have been the trigger that resulted in cascading failures and thence collapse of a building (WTC 7), our investigation was meant to confirm or deny such a conclusion

reached by NIST based on their costly and time-consuming Fire Dynamics Simulator software package. By employing basic thermodynamic principles, equations appropriate to heat flow, together with the combustion properties of materials of wood and plastic-based fuel sources, and normal structural and fire resisting material properties, we came to the opposite conclusion to that of NIST, namely that, regardless of fuel loading chosen, or which of three thicknesses of SFRM selected, fires alone could not have caused the commencement of the collapse of Building 7 at the location cited.

To arrive at such a conclusion, we made the key assumption, not challenged by NIST, that SFRM was employed and was intact during the fire event on 9/11. We also made the assumption that the heat release rates of fires were intense and constant for duration times of 25 or 30 minutes and impinged structural surfaces in the form of radiation and circulating hot gases with a constant temperature determined by the fuel load assumed and the distance of the ceiling above any given cubicle's partition height. At the end of the burn period, we concluded that floor beam K3004, located on the 13th floor, and which was exposed to hot flames in the 12 storey, either over its half length or even its full length, could not have elongated enough to cause a crucial walk-off of its adjoining girder. This conclusion is valid, whether or not shear connectors were present or not.

REFERENCES

- Feasey R, Buchanan A (2002). Post flashover fires for structural design. *Fire Safety Journal*, 37, 83-105.
- Frankel Steel Limited (1985a). Erection Drawing E12.13, 7 World Trade Center.
- Frankel Steel Limited (1985b). Fabrication Shop Drawing, 7 World Trade Center.
- Frater G, Kleinfeldt C (2001). Fire protection of steel structures. *Advantage Steel*, 16-19.
- Gray WA, Muller R (1974). Engineering Calculations in Radiative Heat Transfer, Pergamon Press, Oxford.
- Jonsdottir AM, Stern-Gottfried J, Rein G (2010). Comparison of resultant steel temperatures using travelling fires and traditional methods: Case study for the informatics forum building. *Proceedings of the 12th International Interflam Conference*, Nottingham, U.K.
- Jowsey A, Scott P (2014). Structural Steel Protection: Engineered Solutions, AkzoNobel International.
- NIST (2008a). Final Report on the Collapse of World Trade Center Building 7. NIST-NCSTAR 1A, National Institute of Standards and Technology, Gaithersburg, Md.
- NIST (2008b). Status of NIST's Recommendations Following the Federal Building and Fire Investigation of the World Trade Center Disaster, National Institute of Standards and Technology, Gaithersburg, Md.
- NIST (2008c). Structural Fire Response and Probable Collapse Sequence of World Trade Center Building 7, NCSTAR 1-9, National Institute of Standards and Technology, Gaithersburg, Md.
- NIST (2012). Changes to the NIST Reports of the Federal Building and Fire Investigation of the World Trade Center Disaster, NCSTAR 1-9, National Institute of Standards and Technology, Gaithersburg, Md.
- Oetelaar TA, Johnston CR (2012). Determination of the convective heat transfer coefficient of hot air rising through terracotta flues. *CSME Transactions*, 36 (4), 413.
- Quintierre JG, Williams FA (2014). Comments on the NIST investigation of the world trade center fires. *Journal of Fire Sciences*, 32, 281-291.

Petterson O, Magnusson S-E, Thor J (1976). Fire Engineering Design of Steel Structures. Swedish Institute of Steel Structures, Publication 50.

Ruddy J, Marlo JP, Ioannides SA, Alfawakhiri F (2002). Fire Resistance of Structural Steel Framing. AISC Steel Design Guide 19, Chicago, IL.

Salvarinas JJ (1986). Seven world trade center, New York, fabrication and construction aspects. *Canadian Structural Engineering Conference Proceedings*, Canadian Steel Construction Council, Willowdale, Ontario, pp 11-1 to 11-44.