

# FEM Analysis of Connecting Rod of different materials using ANSYS

Prateek Joshi<sup>1</sup>, Mohammad UmairZaki<sup>2</sup>

1(Department of Mechanical Engineering, Noida International University, Greater Noida, India)

2 (Faculty of Mechanical Engineering, Noida International University, Greater Noida, India)

## Abstract:

Connecting Rods are practically generally used in all varieties of automobile engines. Acting as an intermediate link between the piston and the crankshaft of an engine. It is responsible for transmission of the up and down motion of the piston to the crankshaft of the engine, by converting the reciprocating motion of the piston to the rotary motion of crankshaft. Thus, this study aims to carry out for the load, strain and stress analysis of the crank end of the connecting rod of different materials. Based on which the High Strength Carbon Fiber connecting rod will be compared with connecting rod made up of Stainless Steel and Aluminum Alloy. The results can be used for optimization for weight reduction and for design modification of the connecting rod. Pro-E software is used for modeling and analyses are carried out in ANSYS software. The results archived can also help us identify the spot or section where chances of failure are high due to stress induced. Also the results obtained can be used to modify the existing designs so that better performance and longer life cycle can be archived.

**Keywords** —Connecting Rod, Pro-E, FEA, ANSYS Workbench, Crank, Crankshaft, Piston, Carbon Fiber, Stainless Steel, Aluminum Alloy.

## I. INTRODUCTION

Connecting Rods are used practically generally used in all varieties of automobile engines. Acting as an intermediate link between the piston and the crankshaft of an engine of an automobile. It is responsible for transmission the up and down motion of the piston to the crankshaft of the engine, by converting the reciprocating motion of the piston to the rotary motion of crankshaft. While the one end, small end the connecting rod is connecting to the piston of the engine by the means of piston pin, the other end, the bigger end being connected to the crankshaft with lower end big end bearing by generally two bolts.

Generally connecting rods are being made up of stainless steel and aluminium alloy through the forging process, as this method provides high productivity and that too with a lower production cost. Forces generated on the connected rod are generally by weight and combustion of fuel inside cylinder acts upon piston and then on the

connecting rod, which results in both the bending and axial stresses.

Therefore it order to study the strain intensity, stress concentration and deformation in the crank end of the connection rod, firstly based on the working parameter and the vehicle chosen the design parameter or dimensions of the connecting rod is calculated, then the model of the connecting rod parts is prepared and finally it is analysed using Finite Element Method and results thus achieved will provide us the required outcome of the work done here .Also further study can also be carried out later on for the dynamic loading working conditions of the connecting rod and also improvement in design can also be made for operation condition and longer life cycle against failure.

Pro/ENGINEER Wildfire 4.0 software is used for modelling of the connecting rod model and ANSYS 13 is analysis. ANSYS being an analysis system which stands for “Advanced Numerical System Simulation”. It is an CAE software, which

has many capabilities, ranging from simple static analysis to complex non-linear, dynamic analysis, thermal analysis, transient state analysis, etc. By solid modeling software, the geometric shape for the model is described, and then the ANSYS program is used for meshing the geometry for nodes and elements. In order to obtain the desirable results at each and every point of the model, the fine meshing is done which also results in accurate results output. In this study the elements formed after meshing are tetrahedral in shape. Loads and boundary constraints in the ANSYS can be applied on the surfaces and volume as required. Finally the results calculation is done by the ANSYS software and the desired output results can be achieved.

## II. FINITE ELEMENT METHOD

The finite element method (FEM) is a numerical technique for solving problems to find out approximate solution of a problem which are described by the partial differential equations or can also be formulated as functional minimization. A principle of interest is represented as an assembly of finite elements. Approximating functions in the finite elements are determined in the terms of the nodal values of a physical field which is sought. FEM subdivides a whole problem or entity into numbers of smaller simpler parts, called finite elements, and solve these parts for the problems. The main advantage of FEM is that it can handle complicated boundary and geometries with very ease.

Steps for the Finite Element Method are:-

- Modelling the Model
- Import the model
- Defining element type
- Defining material properties
- Meshing of model
- Applying boundary constraints
- Applying load
- Results and Analysing it.

## III. SPECIFICATION OF THE PROBLEM

The objective of the present work is to design and optimize a connecting rod based upon its material properties by using connecting rod of different materials. Here Stainless Steel, Aluminum Alloy and High Strength Carbon fiber 280gsm bidirectional are used to analyze the connecting rod. The material of connecting rod will be optimized depending upon the analysis result output. CAD model of connecting rod will be modelled in Pro-E and then be analyzed in ANSYS Software. After analysis a comparison will be made between existing material and alternate material which will be suggested for the connecting rod in terms of deformation, stresses and strain and the desired output results can be achieved.

## IV. OBJECTIVE

1. Designing of the analysis rod based on the input parameters and then modeling of the connecting rod in the Pro/ENGINEER Wildfire 3.0 software.
2. FEM tool software ANSYS 13.0 is given model and material input based on the parameters obtained.
3. To determine the Von Mises stresses, Strain Intensity, Total Deformation and to optimize in the existing Connecting rod design.
4. To calculate stresses in critical areas and to identify the spots in the connecting rod where there are more chances of failure.
5. To reduce weight of the existing connecting rod based on the magnitude of the output of analysis.

The main aim of the project is to determine the Von-Mises Stresses, Strain Intensity output and optimize the new material used for connecting rod. Based on which the new material can be compared with the existing materials used for Connecting Rod.

## V. PRESSURE CALCULATION FOR CONNECTING ROD

Engine type air cooled 4-stroke  
Bore x Stroke = 57.0 x 58.6 mm  
Displacement = 149.5 cc

Maximum Power = 13.8bhp@8500rpm

Maximum Torque = 13.4Nm@6500rpm

Compression Ratio = 9.35: 1

Density of petrol  $C_8H_{18}$   
 $=737.22\text{kg/m}^3=737.22\text{E-}9\text{ kg/mm}^3$

Flash point for petrol (Gasoline)

Flash point =  $-43^\circ\text{c} (-45^\circ\text{F})$

Auto ignition temp. =  $280^\circ\text{c} (536^\circ\text{F}) = 553^\circ\text{k}$

Mass = Density x volume

$= 737.22\text{E-}9 \times 19.5\text{E}3$

$= 0.110214\text{kg}$

Molecular weight of petrol =  $114.228\text{g/mole}$

$= 0.11423\text{ kg/mole}$

From gas equation,

$PV=m * R_{\text{specific}} * T$

Where, P = Pressure, MPa

V = Volume

m = Mass, kg

$R_{\text{specific}}$  = Specific gas constant

T = Temperature, °k

$R_{\text{specific}} = R/M$

$R_{\text{specific}} = 8.3143/0.114228$

$R_{\text{specific}} = 72.76\text{ Nm/kg K}$

$P = m.R_{\text{specific}}.T/V$

$P = (0.110214 \times 72.757 \times 553) / 149.5$

$= 29.67\text{ MPa}$

Calculation of analysis is done for maximum Pressure of 30 MPa and 15 MPa.

## VI. DESIGN CALCULATION FOR THE CONNECTING ROD

In general,

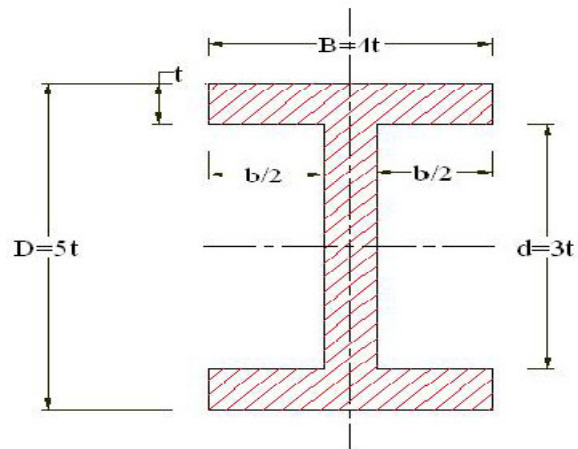

Figure 1: I Section Standard Dimensions of connecting rod

From standards,

- Thickness of the flange & web of the section = t
- Width of the section,  $B = 4t$
- Height of the section,  $H = 5t$
- Area of the section,  $A = 11t^2$
- Moment of inertia about x-axis,  $I_{xx} = 34.91t^4$
- Moment of inertia about y-axis  $I_{yy} = 10.91t^4$
- Therefore  $I_{xx}/I_{yy} = 3.2$

Length of the connecting rod (L) = 2 times stroke

$L = 117.2\text{ mm}$

Total Force acting  $F = F_p - F_l$

Where  $F_p$  = force acting on the piston

$F_l$  = force of inertia

$F_p = \left(\frac{\pi d^2}{4}\right) \times \text{gas pressure}$

$F_p = 39473.1543\text{ N}$

$F_l = \frac{1000wr v^2}{gr} \times \text{Cos}\theta \pm \frac{\text{Cos}2\theta}{n^l}$

wr = weight of the reciprocating parts

$wr = 1.6 * 9.81 = 15.696\text{ N}$

r = crank radius

r = stroke of piston / 2

$r = 58.6/2 = 29.3$

Also,  $\theta$  = Crank angle from dead center

$\theta = 0$  considering connecting rod is at TDC position

$n^l$  = length of connecting rod / crank radius

$$n^l = 117.2/29.3 = 4$$

$$g = \text{acceleration due to gravity, } 9.81$$

$$v = \text{crank velocity m/s}$$

$$w = 2\pi n/60$$

$$w = 2\pi 8500/60 = 890.1179$$

$$v = rw = 29.3e-3 * 890.1179 = 26.08$$

On substituting these,

$$F_l = 9285.5481$$

Thus,

$$F = 39473.1543 - 9285.5481$$

$$F = 30187.6062 \text{ N}$$

Now, According to Rankine's - Gordon formula,

$$F = \frac{F_c A}{1 + a\left(\frac{L}{K_{xx}}\right)^2}$$

Let,

A = Cross-section area of connecting rod,

L = Length of the connecting rod

$F_c$  = Compressive yield stress,

F = Buckling load

$I_{xx}$  &  $I_{yy}$  = Radius of gyration of section about the x - x and y - y axis resp.

$K_{xx}$  &  $K_{yy}$  = Radius of gyration of section about x - x and y - y axis resp.

### For Stainless Steel

On substituting these to Rankine's formula

$$30187.6 = \frac{170 * 11t^2}{1 + 0.002\left(\frac{117.2}{1.78t}\right)^2}$$

Thus by solving we get,

$$= 4.7321$$

Therefore

$$\text{Width B} = 4t = 18.9284 \text{ mm}$$

$$\text{Height H} = 5t = 23.6605 \text{ mm}$$

$$\text{Area A} = 11t = 246.32 \text{ mm}^2$$

$$\text{Height at the piston end } H_1 = 0.75H - 0.9H$$

$$H_1 = 0.75 * 23.66 = 17.745 \text{ mm}$$

$$\text{Height at the crank end } H_2 = 1.1H - 1.25H$$

$$H_2 = 1.1 * 23.66 = 26.026 \text{ mm}$$

$$\text{Length of the connecting rod (L)} = 117.2 \text{ mm}$$

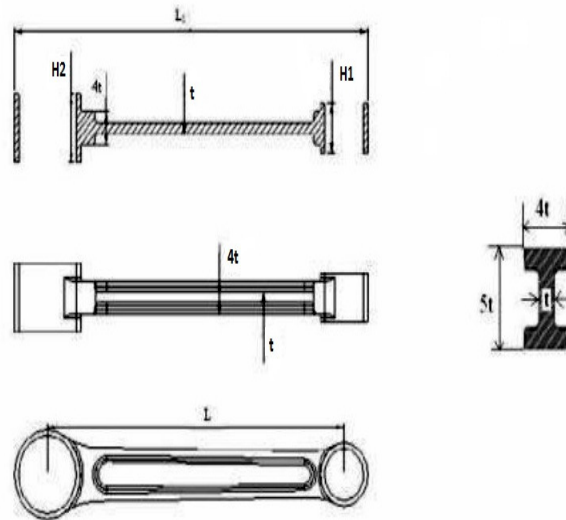

Figure 2: Connecting Rod General Dimensions

### Design of small end:

Load on the piston pin or the small end bearing ( $F_p$ )

= Projected area \* Bearing pressure

$$F_p = d_p l_p * P_{bp}$$

$$F_p = 39473.154 \text{ N load on the piston pin,}$$

$$d_p = \text{Inner dia. of the small end}$$

$$P_{bp} = \text{Bearing pressure}$$

$$= 10.0 \text{ for oil engines.}$$

$$= 12.7 \text{ for automotive engines.}$$

We assume it is a 150cc engine, thus

$$P_{bp} = 10 \text{ MPa}$$

$$L_p = \text{length of the piston pin}$$

$$= 1.5 d_p$$

Substituting,

$$39473.154 = 1.5 d_p \cdot d_p \times 10$$

$$d_p = 51.29 \cong 51 \text{ mm}$$

$$L_p = 1.5 d_p = 76.5 \text{ mm}$$

$$\text{Outer diameter of small end} = d_p + 2t_b + 2t_m$$

$$= 51 + [2 \times 2] + [2 \times 5]$$

$$= 65 \text{ mm}$$

Where,

Thickness of bush ( $t_b$ ) = 3 to 5 mm

Marginal thickness ( $t_m$ ) = 5 to 10 mm

### Design of Big end:

Load on crankpin or the big end bearing ( $F_p$ ) =

Projected Area \* Bearing pressure

$$F_p = dplp * P_{bp}$$

$$F = 39473.154 \text{ N force or load on piston pin}$$

$$d_c = \text{Inner dia. of big end}$$

$$L_c = \text{length of crankpin}$$

$$= 1.25 d_c$$

$$P_{bc} = 7.5 \text{ MPa}$$

Putting these,

$$39473.154 = 1.25 d_c \cdot d_c 7.5$$

$$d_c = 64.88 \cong 65 \text{ mm}$$

$$L_c = 1.5 d_p = 97.5 \text{ mm}$$

Outer diameter of the big end =

$$d_c + 2t_b + 2t_m + 2d_b$$

$$= 65 + [2 \times 2] + [2 \times 5] + [2 \times 4]$$

$$= 87 \text{ mm}$$

Where,  
Thickness of bush ( $t_b$ ) = 3 - 5 mm

Marginal thickness ( $t_m$ ) = 5 - 10 mm  
Marginal thickness for bolt ( $d_b$ ) = 3 - 6 mm

**Design of Big end Bolts:**

Force on bolts =  $\frac{\pi}{4} (d_{cb})^2 \times \sigma_t \times n_b$

$$d_{cb} = \text{Core dia. of bolts}$$

$$\sigma_t = \text{Allowable tensile stress for material of the bolts}$$

$$= 12 \text{ MPa assume}$$

$$n_b = \text{Number of bolts (2 bolts are used)}$$

$$= \frac{\pi}{4} (d_{cb})^2 \times 12 \times 2$$

$$= 18.85 (d_{cb})^2$$

Also,  
The bolts and the big end cap are subjected to the tensile forces which correspond to inertia forces on the reciprocating parts at the TDC while on the exhaust stroke.

We know that inertia force on the reciprocating parts

$$F_I = \frac{1000wr v^2}{gr} \times \text{Cos}\theta \pm \frac{\text{Cos}2\theta}{n^l}$$

As calculated above,

F = 9285.5481 N  
Equating Inertia force, to force on bolts,

S.no.	Parameters (mm)
1	Thickness of the connecting rod (t) = 4.7
2	Width of the section (B = 4t) = 18.92
3	Height of the section (H = 5t) = 23.66
4	Height at the big end = (1.1 to 1.125)H = 26.02
5	Height at the small end = 0.9H to 0.75H = 17.74
6	Inner diameter of the small end = 51
7	Outer diameter of the small end = 65
8	Inner diameter of the big end = 65
9	Outer diameter of the big end = 87

Table 1: Dimensional Specifications of the connecting rod

$$9285.5481 = 18.85 (d_{cb})^2$$

$$d_{cb} = 22.19$$

Normal diameter of bolts ( $d_{cb}$ )

$$d_{cb} = \frac{d_{cb}}{0.84} = 27.28 \text{ mm}$$

$$\cong 30 \text{ mm}$$

Hence we will use M30 sized bolts.

The materials chosen for analysis of the connecting rod here are Stainless Steel, Aluminum 7075 and High Strength Carbon fiber. These materials were tested using ANSYS software for the stress and strain and other forces acting on the connecting rod based on these material properties as shown in the table 2, below

Material Selected	Stainless Steel	Aluminum Alloy 7075	High Strength Carbon Fiber
Young's Modulus, E	$2.0 \times 10^5$ MPa	71.7 GPa	100 GPa
Poisson's ratio	0.30	0.33	0.10
Density	7850 kg/m <sup>3</sup>	2700 kg/m <sup>3</sup>	1600 kg/m <sup>3</sup>
Shear Modulus	29.6 GPa	26.9 GPa	0.6 Msi
Tensile Strength, Ultimate	460 MPa	572 MPa	75.85 N/mm <sup>2</sup>
Shear Strength	250 MPa	331 MPa	600 MPa

Table 2: Material Properties Used for Analysis

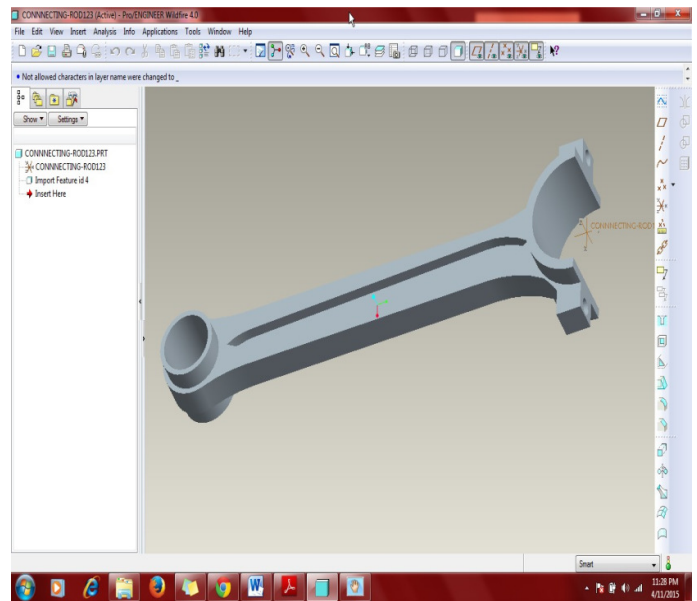

Figure 3: Model of connecting rod in Pro-E

## VII. MODELING OF THE CONNECTING ROD USING PRO-E

Pro-E is used to create a complete 3D digital model of manufactured goods. The models consist of 2D and 3D solid model data which can also be used downstream in finite element analysis, rapid prototyping, tooling design, and CNC manufacturing.

Connecting rod of a Light Vehicle Engine easily available in the market is selected and its dimensions are calculated based on the design and working parameters. According to the dimensions obtained the model of the connecting rod is developed in the Pro/ENGINEER Wildfire 4.0. Model of the connecting rod and its Big end Bearing Lower half the separately developed of this study as shown in figures below,

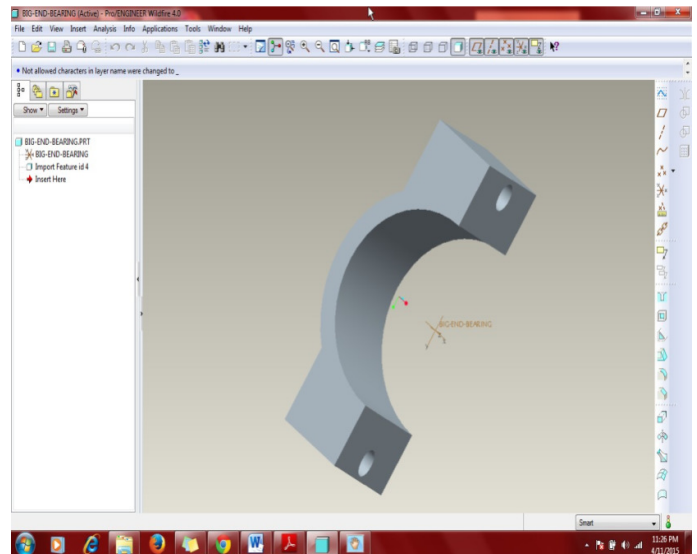

Figure 4: Model of Crank end Bearing Lower half

## VIII. FINITE ELEMENT ANALYSIS USING ANSYS

The analysis of connecting rod models are carried out using ANSYS software using Finite Element Method. Firstly the model files prepared in the Pro-E, then are exported to ANSYS software as an IGES files as shown in figure 5 & 6 below;

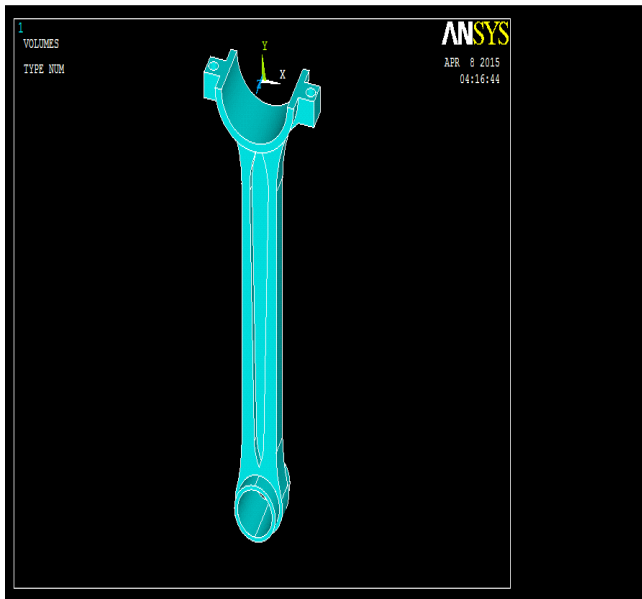

Figure 5: Imported model of Connecting Rod to ANSYS



Figure 7: Meshed model of connecting rod on ANSYS

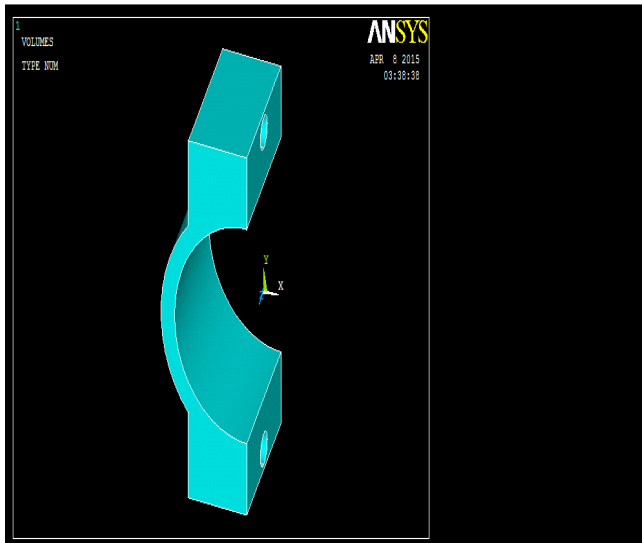

Figure 6: Imported model of the Lower Bearing of Connecting Rod to ANSYS

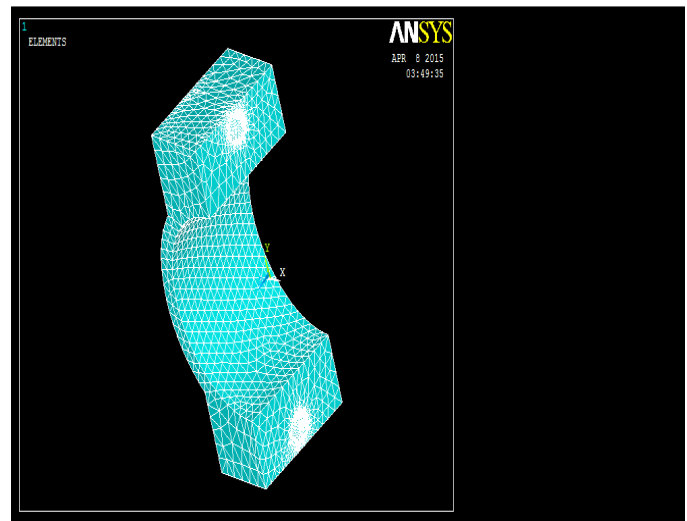

Figure 8: Meshed Model of the Lower Bearing of Connecting Rod in ANSYS

After this areas and sections are segmented as importing the model to ANSYS results in some imperfection. Thus the geometry clean-up is done. Now the material properties are defined on the model for the material used as shown in table above. After that, the meshing of model is to be done. Here a model is divided into a number of elements and nodes. The meshed models of the connecting rod are as shown in figure 7 & 8 below,

Once meshing is done the boundary conditions i.e... DOF constrains, forces, loads are to be applied on the model. As shown fig 9, the pressure is applied on the Crank end bearing of the connecting rod, while keeping piston end fixed. The pressure of 15 & 30 Mpa is used.

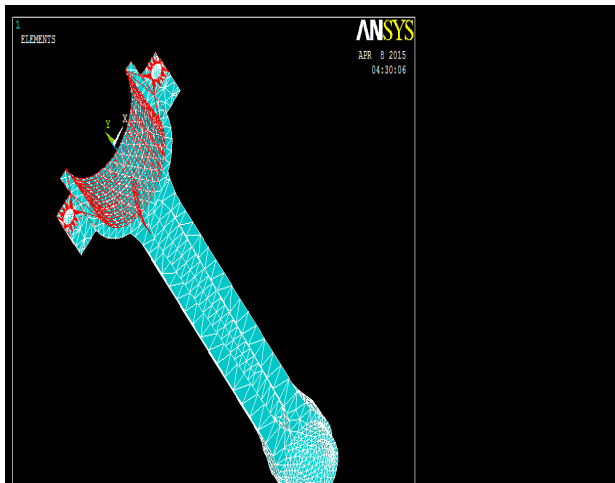

Figure 9: Load constrained section of connecting rod.

Now the Lower half Crank end bearing is taken and boundary constrained and loads are applied on it. As shown in fig 10, the pressure is applied on the bearing face of the model, while keeping bolt area fixed. The pressure of 15 & 30Mpa is used.

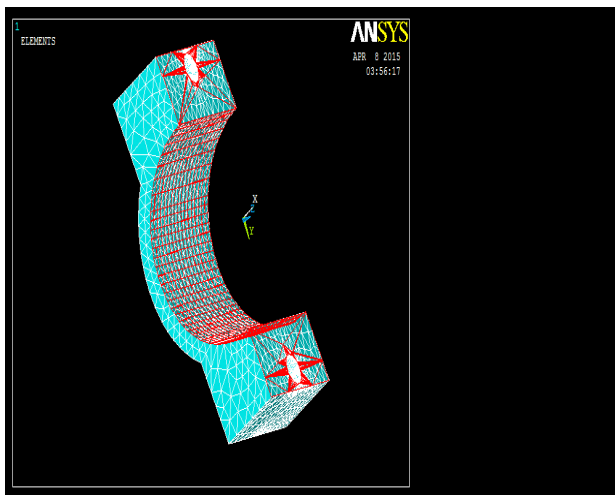

Figure 10: Load constrained section of Lower Crank end Bearing.

### IX. RESULTS OUTPUT OF ANALYSIS:

The static analysis of connecting rod models was conducted for different materials to identify the fatigue locations on it. The term “static” implies that the forces do not change with time. Results of the static analysis output are shown via stress, strain and deformation under the applied load. The output

results of static analysis of both the components are shown in fig below;

Results obtained by ANSYS for the crank end bearing lower half and the connecting rod for stainless steel at the applied pressure of 15mpa.

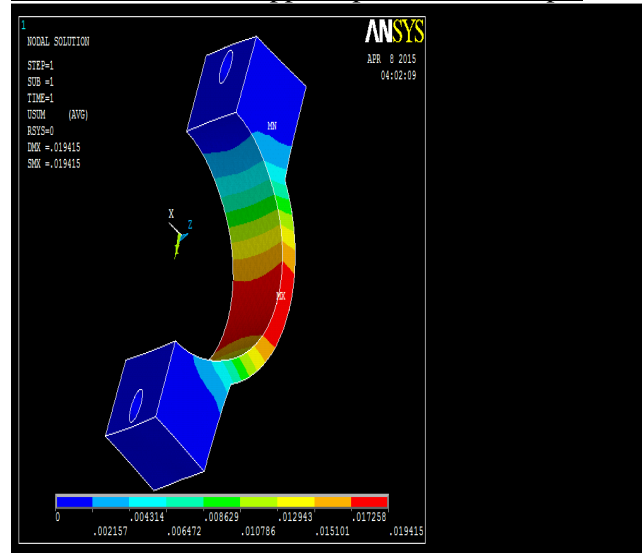

Figure 11: Displacement Output of the Lower Bearing of Stainless Steel Connecting Rod in ANSYS

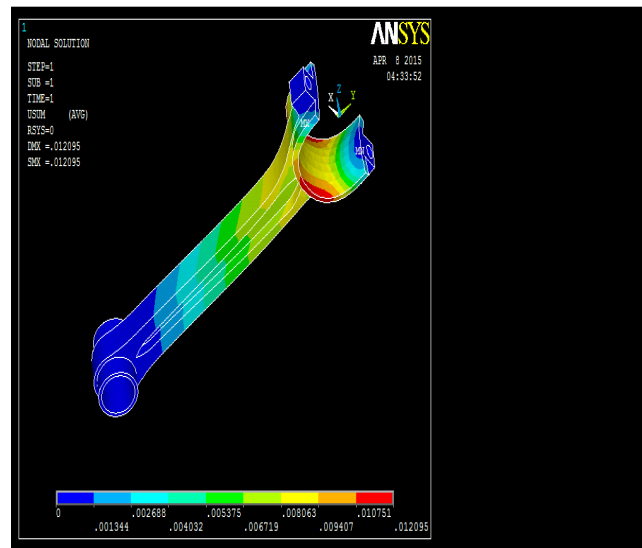

Figure 12: Displacement Output of the Connecting Rod in ANSYS

From the fig 11 the maximum displacement occurs in the Lower Bearing of connecting rod is 0.019415 mm. From the fig 12 the maximum displacement occurs in the connecting rod is 0.012095 mm.



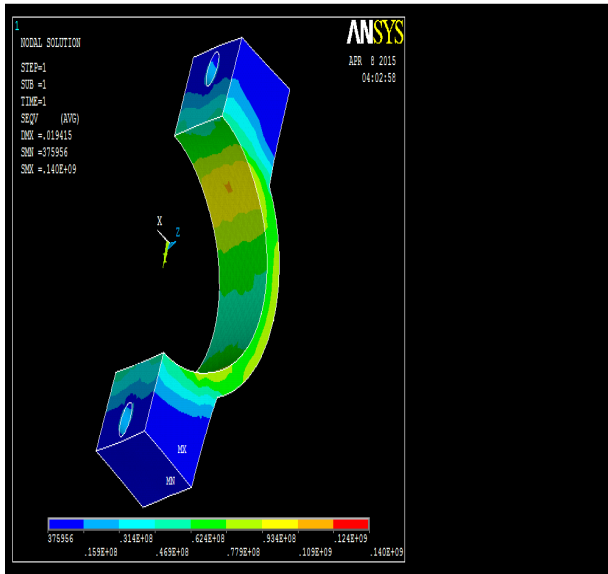

Figure 13: Von-Misses Stress Output of the Lower Bearing of Stainless Steel Connecting Rod in ANSYS

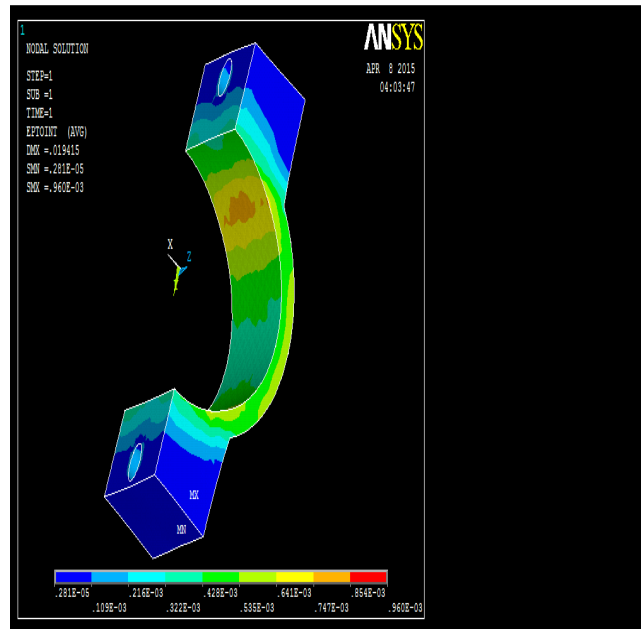

Figure 15: Total Strain Intensity Output of the Lower Bearing of Stainless Steel Connecting Rod in ANSYS

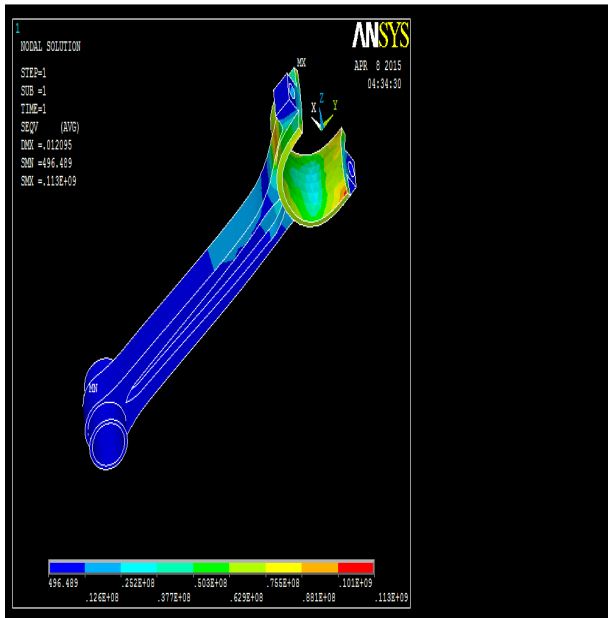

Figure 14: Von-Misses Stress Output of the Stainless Steel Connecting Rod in ANSYS

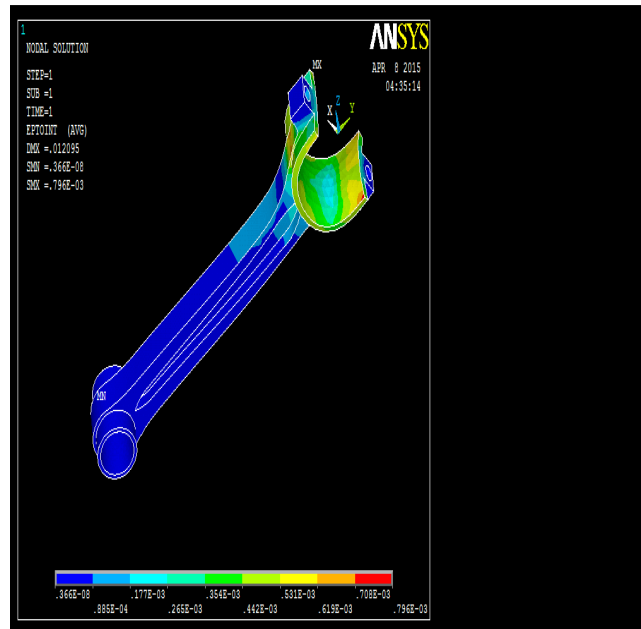

Figure 16: Total Strain Intensity Output of the Stainless Steel Connecting Rod in ANSYS

From the fig 13 the maximum Von-Misses Stress occurs in the Lower Bearing of connecting rod is  $0.140E+09$  MPa. From the fig 14 the maximum Von-Misses Stress occurs in the connecting rod is  $0.113E+09$  MPa.

From the fig 15 the maximum Strain occurs in the Lower Bearing of connecting rod is  $0.960E-03$ . From the fig 16 the maximum Strain occurs in the connecting rod is  $0.796E-03$ .

Results obtained by ANSYS for the crank end bearing lower half and the connecting rod for aluminium alloy at the applied pressure of 15mpa.

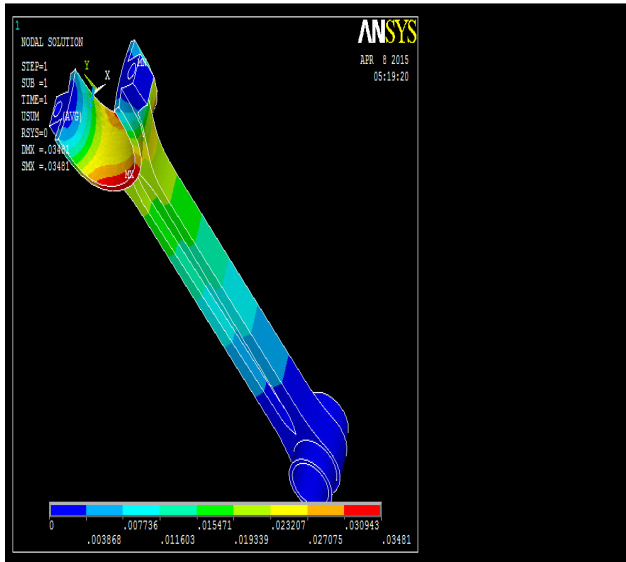

Figure 17: Displacement Output of the Aluminium Alloy Connecting Rod in ANSYS

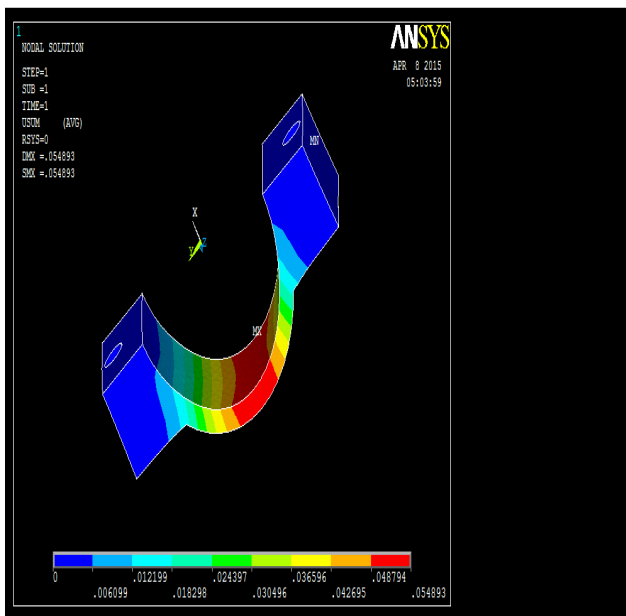

Figure 18: Displacement Output of the Lower Bearing of Aluminium Alloy Connecting Rod in ANSYS

From the fig 18 the maximum displacement occurs in the Lower Bearing of connecting rod is 0.054893 mm. From the fig 17 the maximum displacement occurs in the connecting rod is 0.03481 mm.

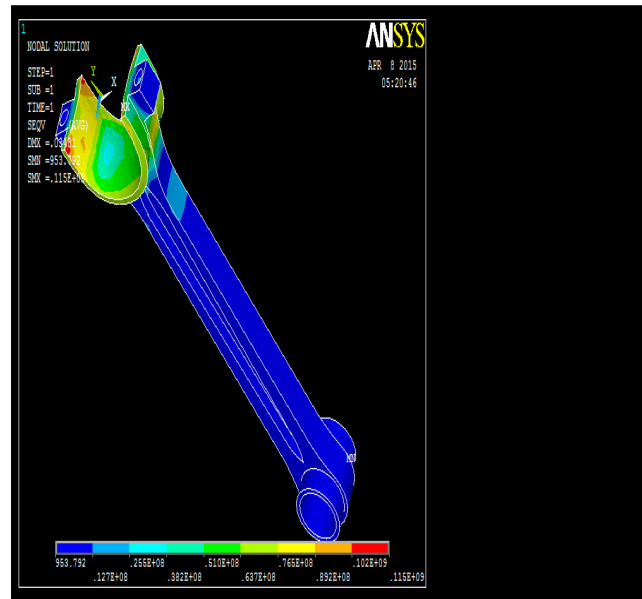

Figure 19: Von-Mises Stress Output of the Aluminium Alloy Connecting Rod in ANSYS

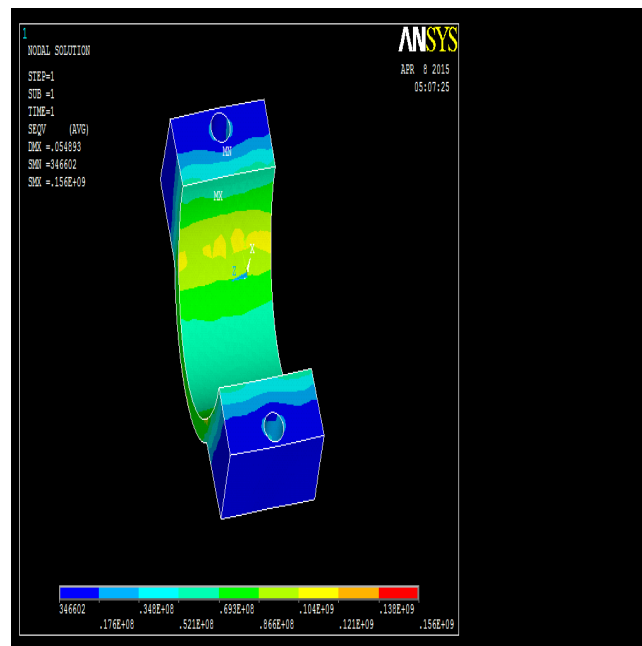

Figure 20: Von-Mises Stress Output of the Lower Bearing of Aluminium Alloy Connecting Rod in ANSYS

From the fig 20 the maximum Von-Mises Stress occurs in the Lower Bearing of connecting rod is 0.156E+09 MPa. From the fig 19 the maximum Von-Mises Stress occurs in the connecting rod is 0.115E+09 MPa.

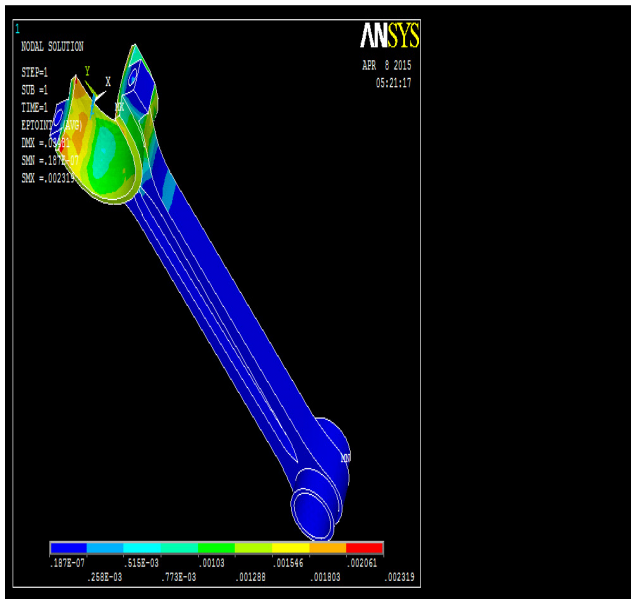

Figure 21: Total Stain Intensity Output of the Aluminum Alloy Connecting Rod in ANSYS

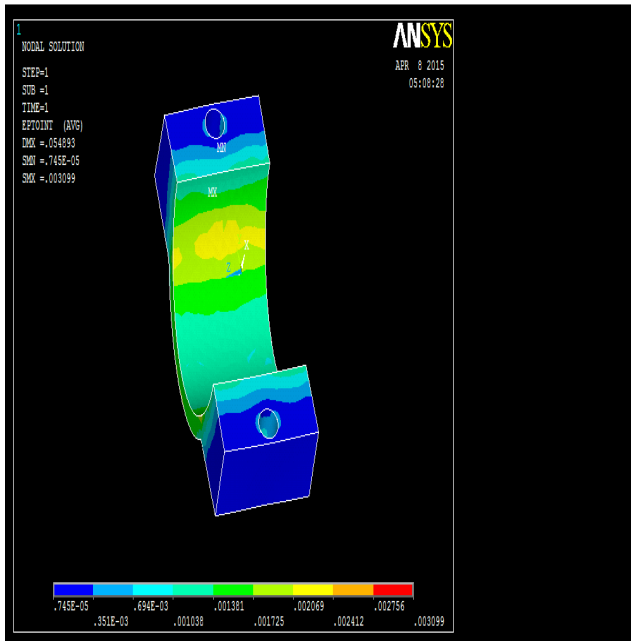

Figure 22: Total Stain Intensity Output of the Lower Bearing of Aluminum Alloy Connecting Rod in ANSYS

From the fig 22 the maximum Strain occurs in the Lower Bearing of connecting rod is 0.003099. From the fig 21 the maximum Strain occurs in the connecting rod is 0.002319.

Results obtained by ANSYS for the crank end bearing lower half and the connecting rod for high strength carbon fiber at the applied pressure of 15mpa.

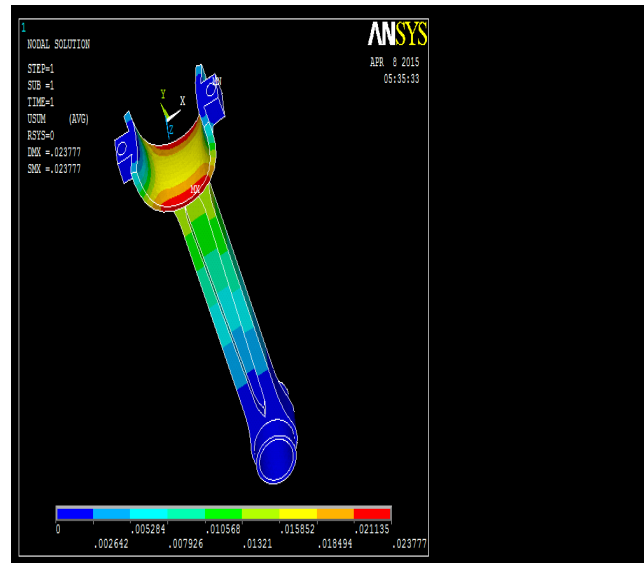

Figure 23: Displacement Output of the High Strength Carbon fiber Connecting Rod in ANSYS

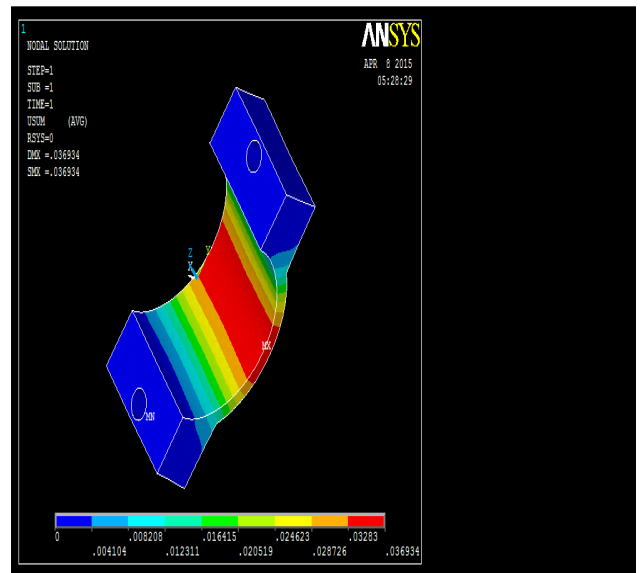

Figure 24: Displacement Output of the Lower Bearing of High Strength Carbon fiber Connecting Rod in ANSYS

From the fig 24 the maximum displacement occurs in the Lower Bearing of connecting rod is 0.036934 mm. From the fig 23 the maximum displacement occurs in the connecting rod is 0.023777 mm.

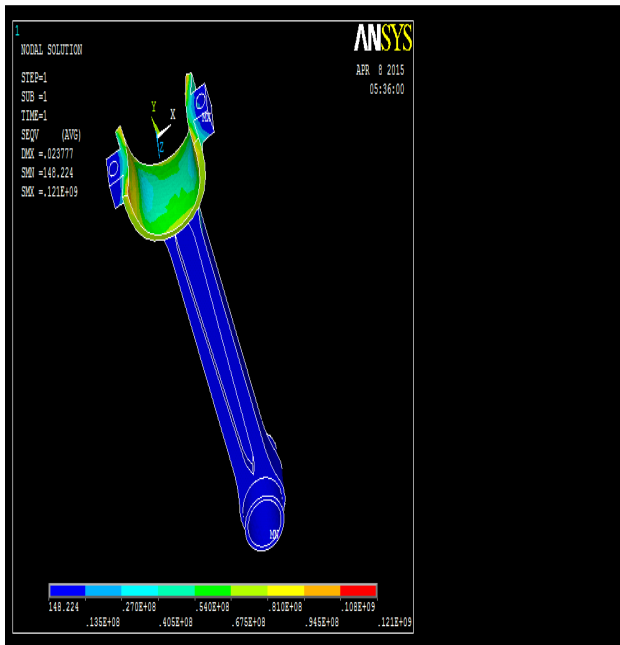

Figure 25: Von-Misses Stress Output of the High Strength Carbon fiber Connecting Rod in ANSYS

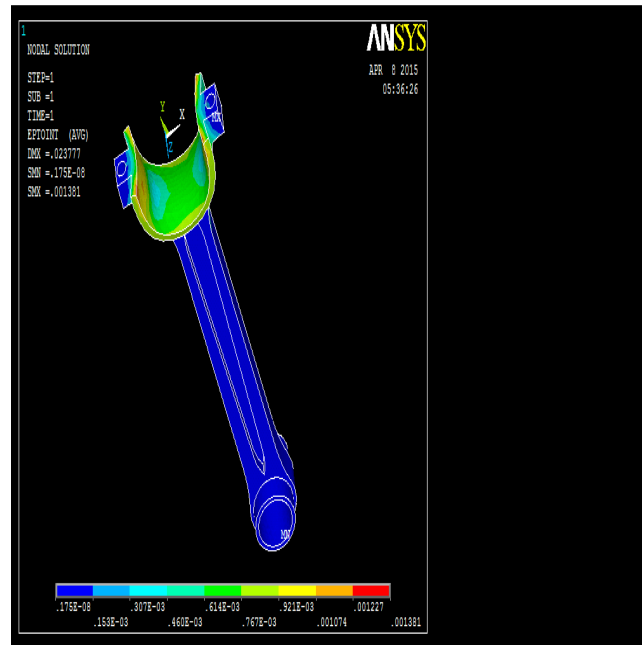

Figure 27: Total Strain Intensity Output of the High Strength Carbon fiber Connecting Rod in ANSYS

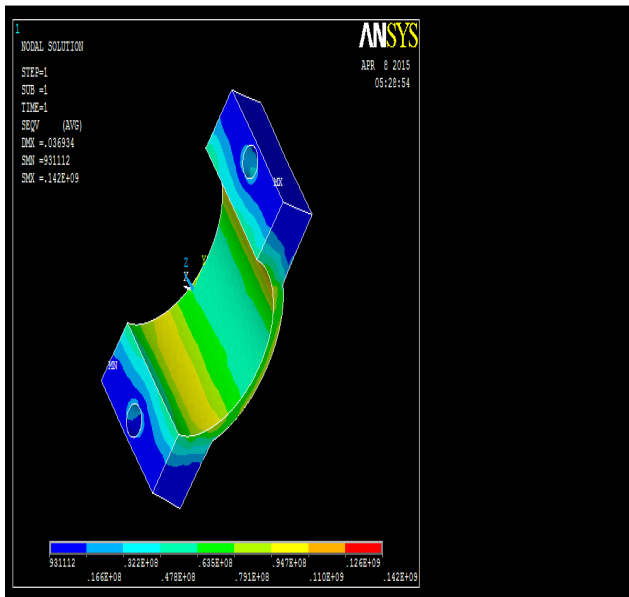

Figure 26: Von-Misses Stress Output of the Lower Bearing of High Strength Carbon fiber Connecting Rod in ANSYS

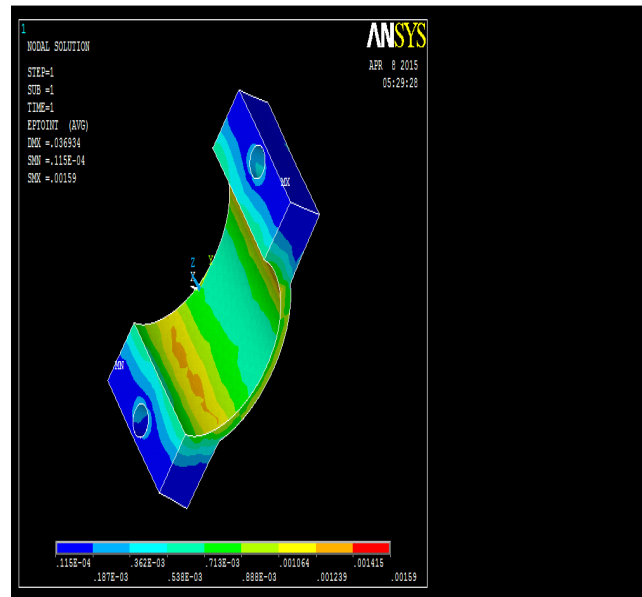

Figure 28: Total Strain Intensity Output of the Lower Bearing of High Strength Carbon fiber Connecting Rod in ANSYS

From the fig 26 the maximum Von-Misses Stress occurs in the Lower Bearing of connecting rod is  $0.142E+09$  MPa. From the fig 25 the maximum Von-Misses Stress occurs in the connecting rod is  $0.121E+09$  MPa.

From the fig 28 the maximum Strain occurs in the Lower Bearing of connecting rod is 0.00159. From the fig 27 the maximum Strain occurs in the connecting rod is 0.001381.

Results obtained by ANSYS for the crank end bearing lower half and the connecting rod for stainless steel at the applied pressure of 30mpa.

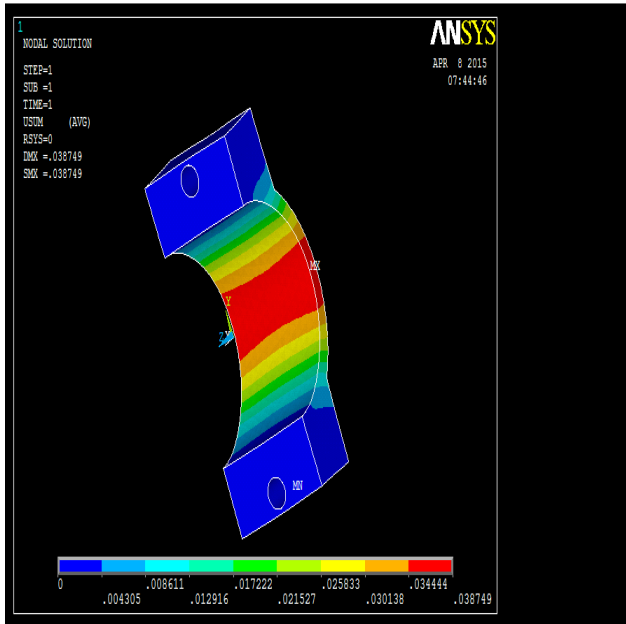

Figure 29: Displacement Output of the Lower Bearing of Stainless Steel Connecting Rod in ANSYS

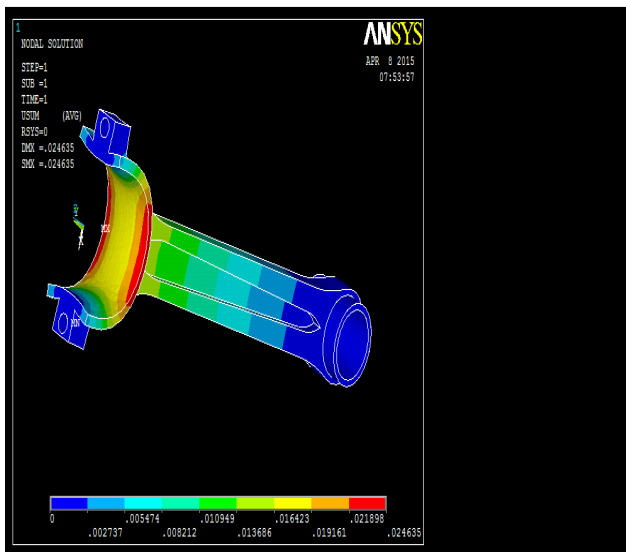

Figure 30: Displacement Output of the Stainless Steel Connecting Rod in ANSYS

From the fig 29 the maximum displacement occurs in the Lower Bearing of connecting rod is 0.038749 mm. From the fig 30 the maximum displacement occurs in the connecting rod is 0.024635 mm.

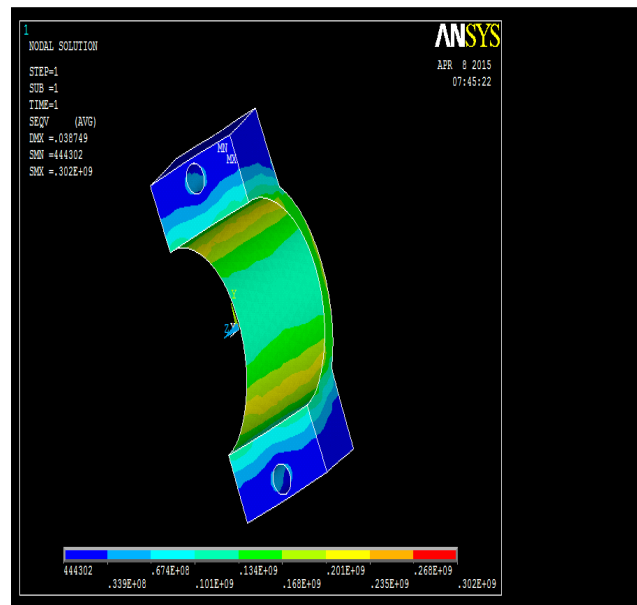

Figure 31: Von-Misses Stress Output of the Lower Bearing of Stainless Steel Connecting Rod in ANSYS

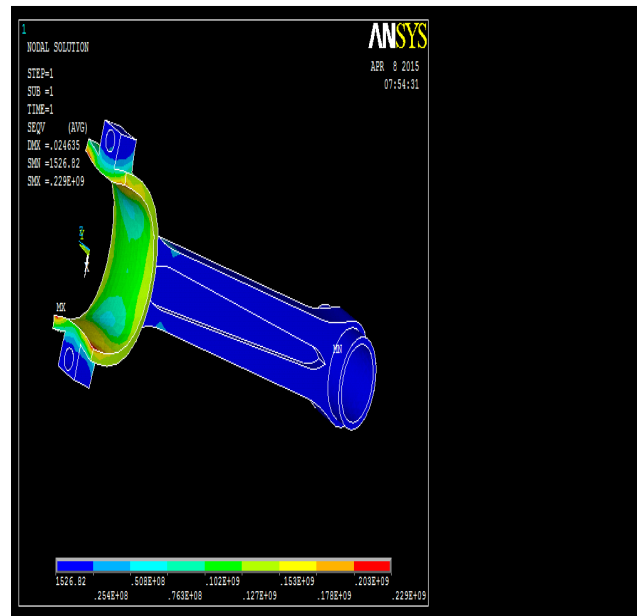

Figure 32: Von-Misses Stress Output of the Stainless Steel Connecting Rod in ANSYS

From the fig 31 the maximum Von-Misses Stress occurs in the Lower Bearing of connecting rod is 0.302E+09 MPa. From the fig 32 the maximum Von-Misses Stress occurs in the connecting rod is 0.229E+09 MPa.

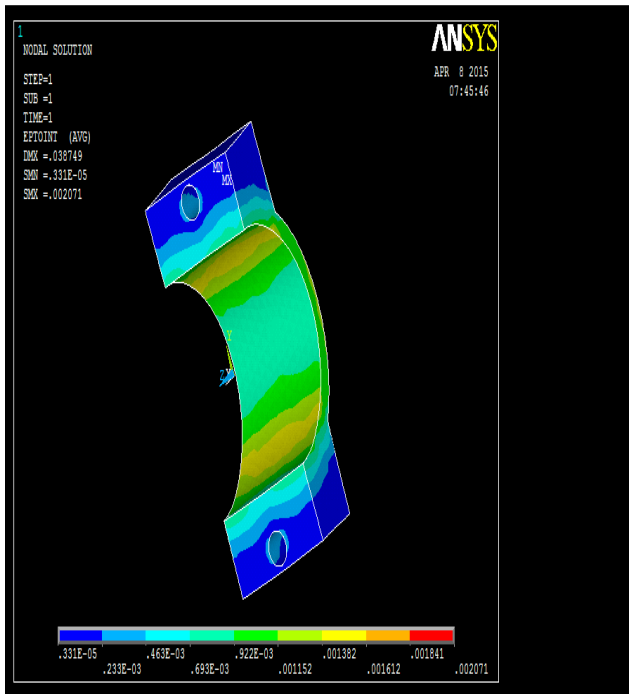

Figure 33: Total Strain Intensity Output of the Lower Bearing of Stainless Steel Connecting Rod in ANSYS

Results obtained by ANSYS for the crank end bearing lower half and the connecting rod for aluminium alloy at the applied pressure of 30mpa.

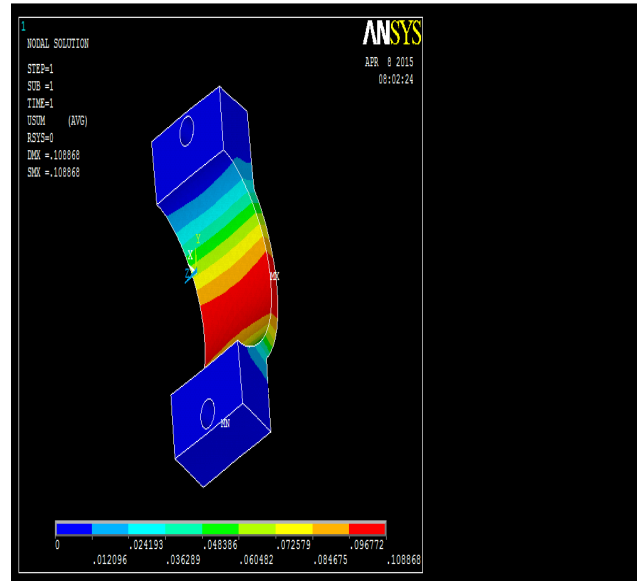

Figure 35: Displacement Output of Lower Bearing of the Aluminium Alloy Connecting Rod in ANSYS

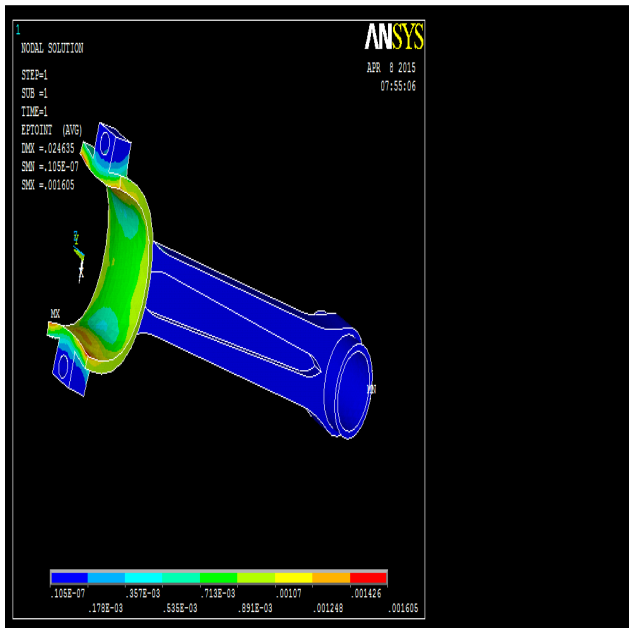

Figure 34: Total Strain Intensity Output of the Stainless Steel Connecting Rod in ANSYS

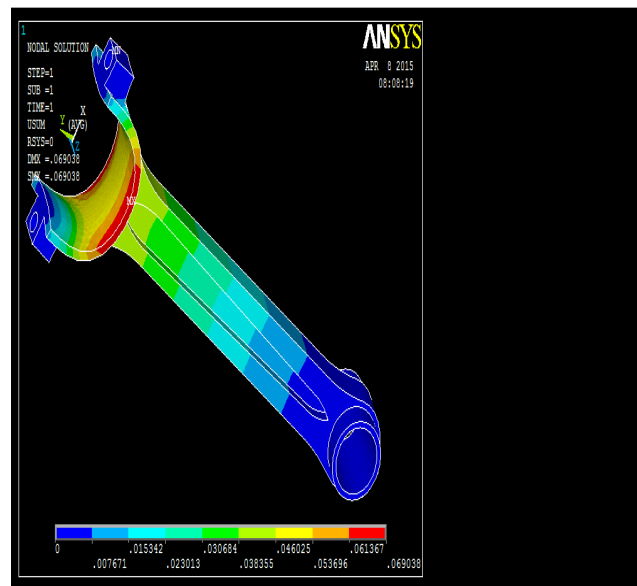

Figure 36: Displacement Output of the Aluminium Alloy Connecting Rod in ANSYS

From the fig 33 the maximum Strain occurs in the Lower Bearing of connecting rod is 0.002071. From the fig 34 the maximum Strain occurs in the connecting rod is 0.001675.

From the fig 35 the maximum displacement occurs in the Lower Bearing of connecting rod is 0.108868 mm. From the fig 36 the maximum displacement occurs in the connecting rod is 0.069038 mm.

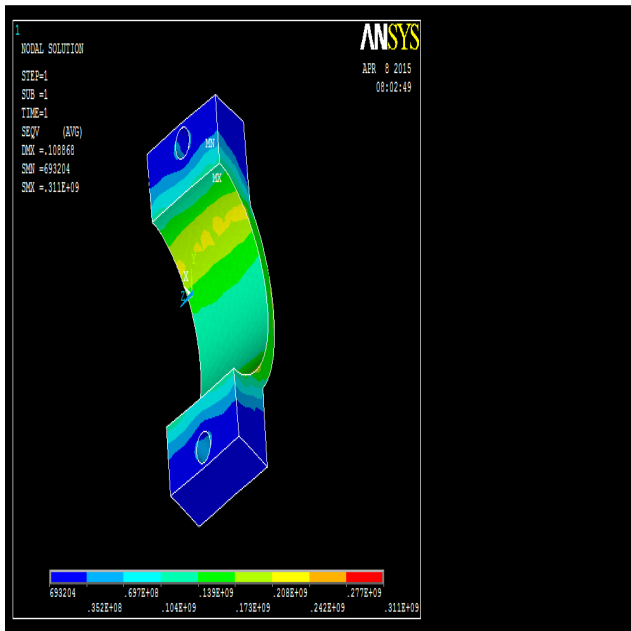

Figure 37: Von-Misses Stress Output of Lower Bearing of the Aluminum Alloy Connecting Rod in ANSYS

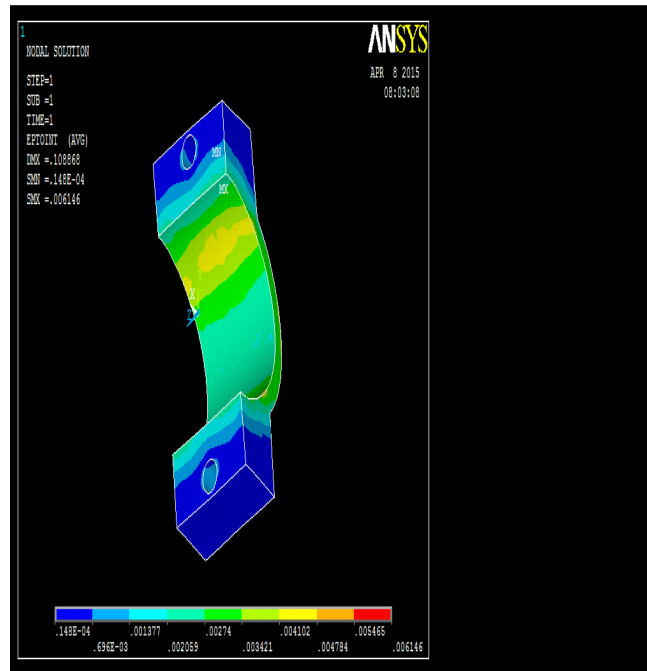

Figure 39: Total Strain Intensity Output of Lower Bearing of the Aluminum Alloy Connecting Rod in ANSYS

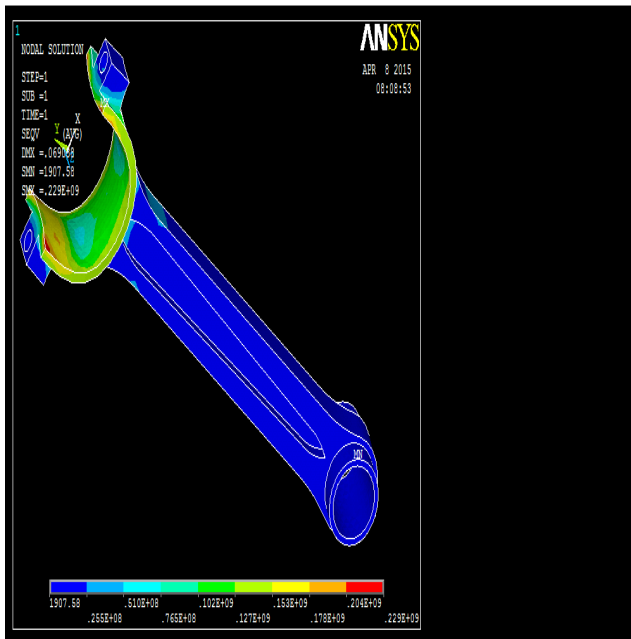

Figure 38: Von-Misses Stress Output of the Aluminum Alloy Connecting Rod in ANSYS

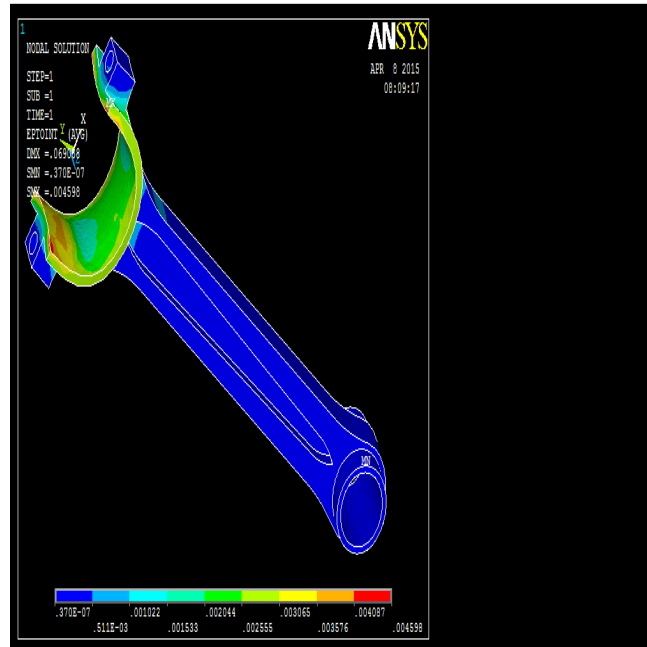

Figure 40: Total Strain Intensity Output of the Aluminum Alloy Connecting Rod in ANSYS

From the fig 37 the maximum Von-Misses Stress occurs in the Lower Bearing of connecting rod is  $0.311E+09$  MPa. From the fig 38 the maximum Von-Misses Stress occurs in the connecting rod is  $0.229E+09$  MPa.

From the fig 39 the maximum Strain occurs in the Lower Bearing of connecting rod is 0.006146. From the fig 40 the maximum Strain occurs in the connecting rod is 0.004598.

Results obtained by ANSYS for the crank end bearing lower half and the connecting rod for high strength carbon fiber at the applied pressure of 30mpa.

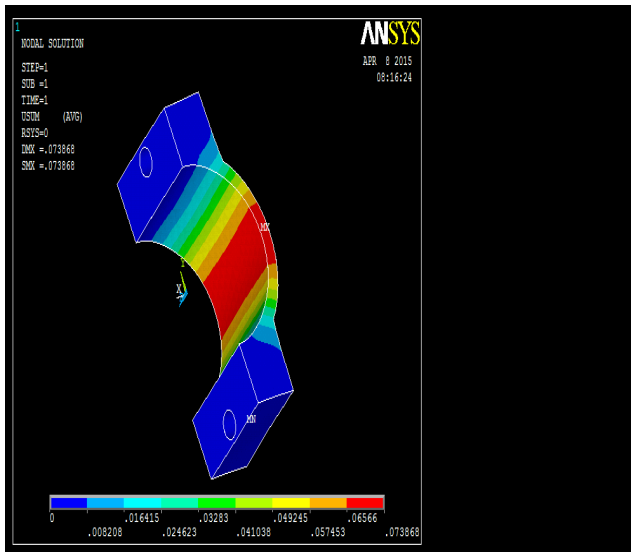

Figure 41: Displacement Output of Lower Bearing of the High Strength Carbon fiber Connecting Rod in ANSYS

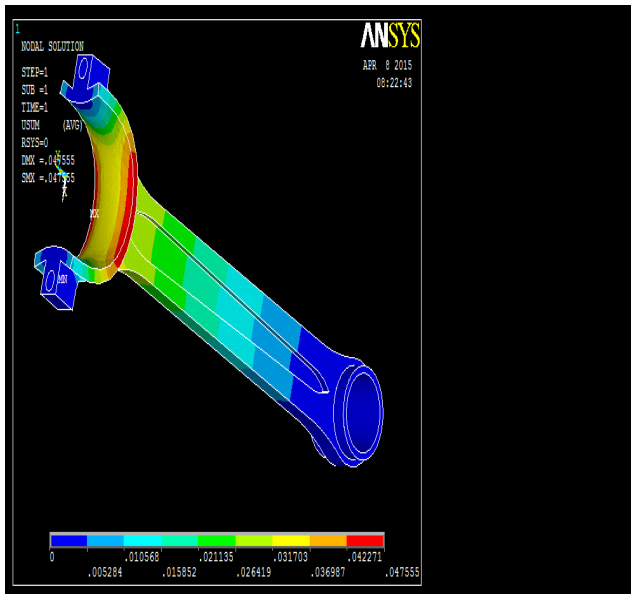

Figure 42: Displacement Output of the High Strength Carbon fiber Connecting Rod in ANSYS

From the fig 41 the maximum displacement occurs in the Lower Bearing of connecting rod is 0.073868 mm. From the fig 42 the maximum displacement occurs in the connecting rod is 0.047555 mm.

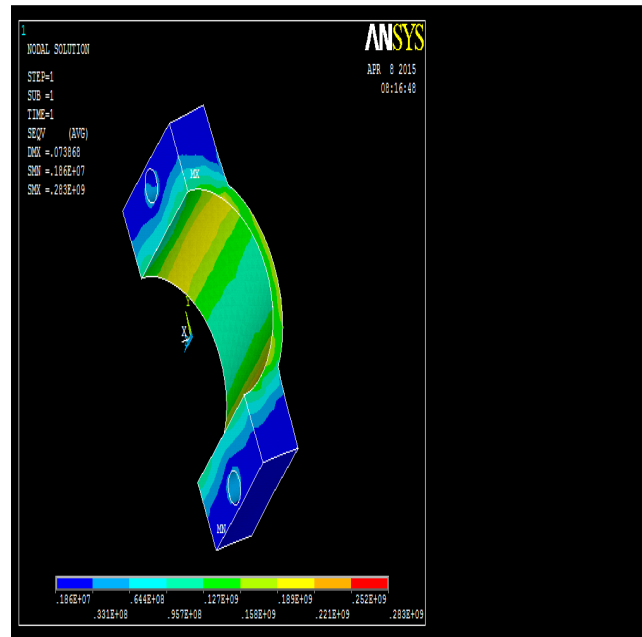

Figure 43: Von-Misses Stress Output of the High Strength Carbon fiber Connecting Rod in ANSYS

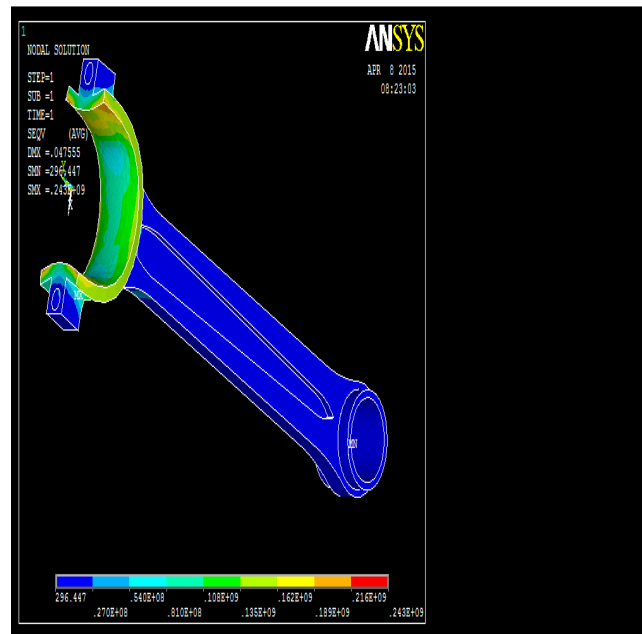

Figure 44: Von-Misses Stress Output of the High Strength Carbon fiber Connecting Rod in ANSYS

From the fig 43 the maximum Von-Misses Stress occurs in the Lower Bearing of connecting rod is 0.283E+09 MPa. From the fig 44 the maximum Von-Misses Stress occurs in the connecting rod is 0.243E+09 MPa.



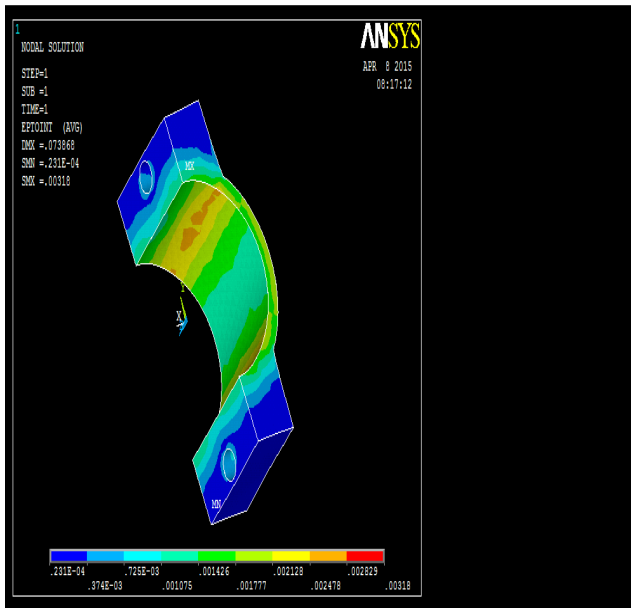

Figure 45: Total Strain Intensity Output of Lower Bearing of the High Strength Carbon fiber Connecting Rod in ANSYS

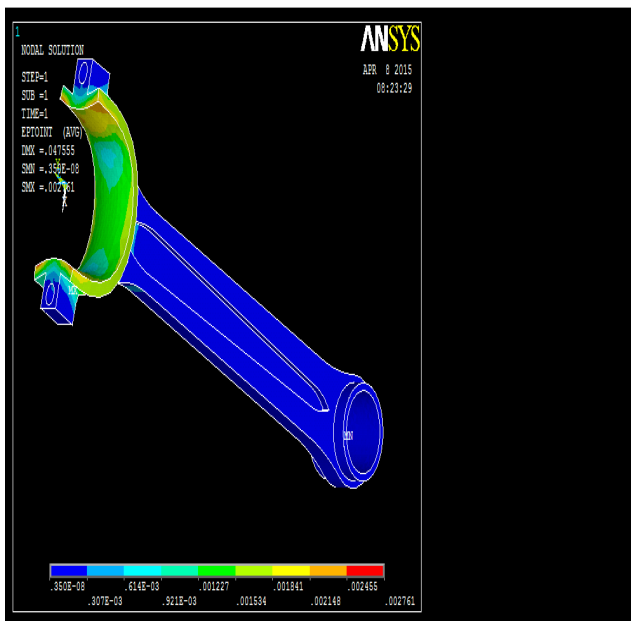

Figure 46: Total Strain Intensity Output of the High Strength Carbon fiber Connecting Rod in ANSYS

From the fig 45 the maximum Strain occurs in the Lower Bearing of connecting rod is 0.00318. From the fig 46 the maximum Strain occurs in the connecting rod is 0.002761.

Based on the results obtained by the ANSYS software for the displacement, Von-Misses Stress and Strain Intensity at the pressure of 15 MPa and 30 MPa the valves for the output obtained can be represented as shown in the tables below.

For 15Mpa Pressure	Stainless Steel	Aluminum Alloy 7075	High Strength Carbon Fiber
--------------------	-----------------	---------------------	----------------------------

Displacement	0.019415	0.054893	0.036934
Von-Misses Stress	0.149E+09	0.156E+09	0.142E+09
Total strain intensity	0.969E-03	0.003099	0.00159

Table 3: Analysis data for Crank End Bearing lower half at 15MPa

For 15Mpa Pressure	Stainless Steel	Aluminum Alloy 7075	High Strength Carbon Fiber
--------------------	-----------------	---------------------	----------------------------

Displacement	0.012095	0.03481	0.023777
Von-Misses Stress	0.113E+09	0.115E+09	0.121E+09
Total strain intensity	0.796E-03	0.002319	0.001381

Table 4: Analysis data for Connecting Rod at 15MPa

For 30Mpa Pressure Stainless Steel Aluminum Alloy 7075 High Strength Carbon Fiber

Displacement	0.038749	0.108868	0.073868
Von-Mises Stress	0.302E+09	0.311E+09	0.283E+09
Total strain intensity	0.002071	0.006146	0.00318

Table 5: Analysis data for Crank End Bearing lower half at 30MPa.

BE- Crank End Bearing Lower half Connecting Rod Cr-

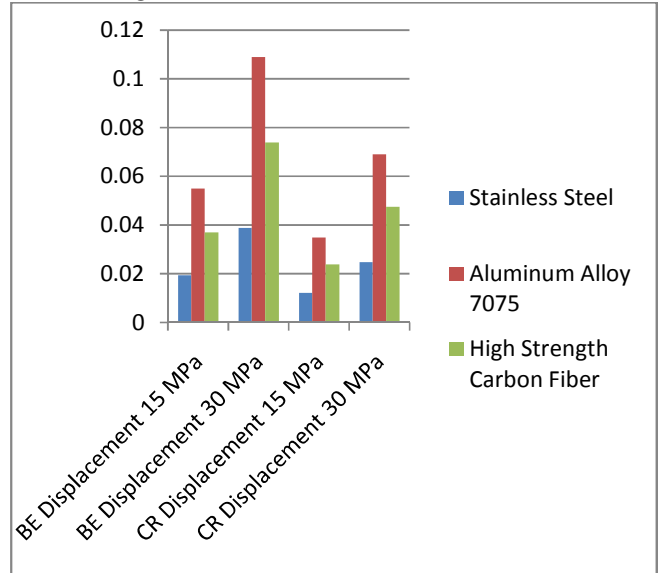

Graph 1: Displacement Output data for Bearing Lower half and Connecting Rod.

For 30Mpa Pressure Stainless Steel Aluminum Alloy 7075 High Strength Carbon Fiber

Displacement	0.024635	0.069038	0.047555
Von-Mises Stress	0.229E+09	0.229E+09	0.243E+09
Total strain intensity	0.001605	0.004598	0.002761

Table 6: Analysis data for Connecting Rod at 30MPa

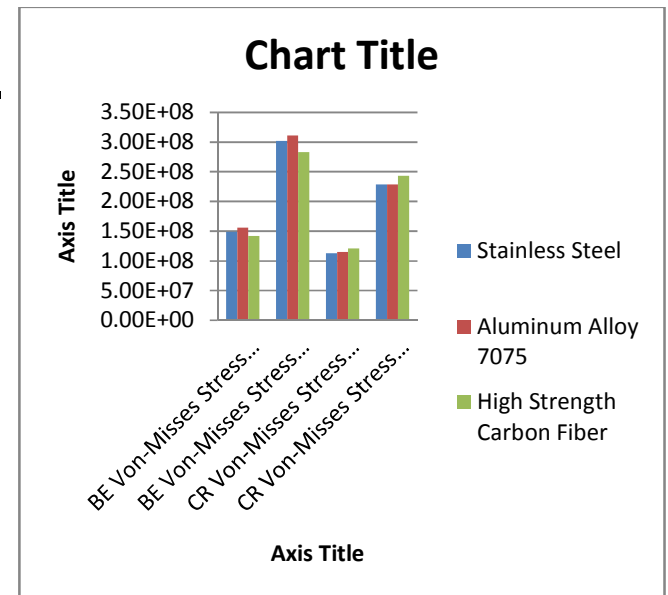

Graph 2: Von-Mises Stress Output data for Crank End Bearing Lower half and Connecting Rod

For comparisons of the results obtained the cumulative graph can be made for both Crank End Bearing Lower half & Connecting Rod for Displacement, Von-Mises Stress and Strain Intensity respectively can as shown below.

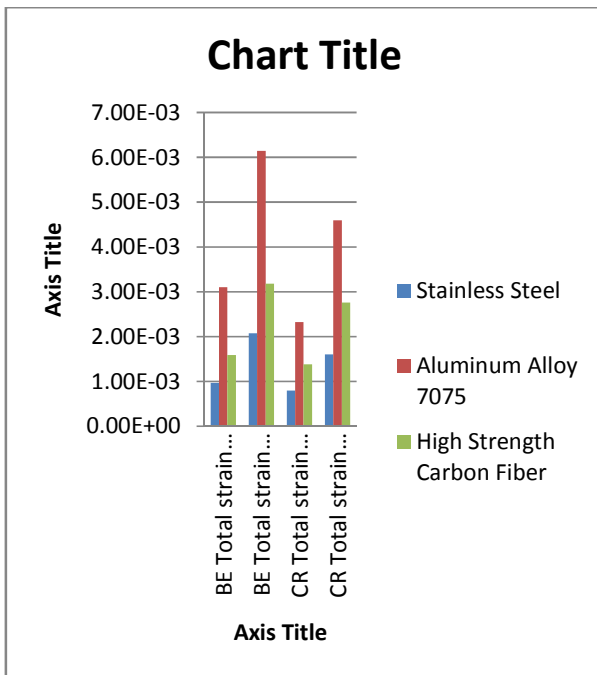

Graph 3: Strain Intensity Output data for Crank End Bearing Lower half and Connecting Rod

## X. CONCLUSIONS

The forces were applied on the piston head and the effect of it on the connecting rod was studied in this analysis. The pressure developed in the big end/crank end of the connecting rod is analysed in two different parts i.e... Crank end Bearing Lower half and connecting rod for displacement, von-misses stress and strain intensity output. The results or conclusion thus that can made on the bases of the output results by ANSYS can be as followed:

- It is observed that displacement, Stress and Strain Intensity induced in the Connecting Rod made up of Carbon fiber is comparatively slightly greater than as compare to the Connecting Rod made up of Stainless Steel, thus more advancement in the field of Carbon Fiber is required to be as equivalent and efficiently used as Stainless Steel.
- Also it was observed that Connecting Rod made up of Aluminium Alloy has higher intensity of Stress and Strain induced as compare to Connecting Rod made up of Carbon Fiber, thus Carbon Fiber can be a good replacement of Aluminium Alloy.

- It was observed that Von-misses Stress Intensity in the both the component Crank end Bearing Lower Half and the Connecting Rod for carbon fiber is lesser as compare to the that of Stainless Steel and Aluminium Alloy. Also manufacturing of complex shape and curved surfaces from Carbon Fiber is much easier and convenient than that of other materials used here.
- Though the intensity of displacement in Carbon fiber is much greater than that of Stainless Steel, but this can in minimize by adding more layers of carbon fiber during manufacturing process as it will increase the overall strength of component that too at much lesser increase in overall weight.
- It can observed from the displacement, Von-misses stress and Strain Intensity Output obtained that the hot spot or the areas where the stresses and strain intensity in higher can be minimize by adding material i.e... increasing the thickness of that area and also the areas where the stress and strain intensity in less, the materials can be removed from that spot or area in order to decrease the weight of the component.
- The composite material like carbon fiber has good strength and also being lighter than both Stainless steel and Aluminium Alloy 7075 can be used for connecting rod with the more easily in the near future.
- Also lighter weight of connecting rod (made up of High Strength Carbon fiber) can also help in reducing weight of engine block of the automobile, thus increasing fuel economy and thus also decreasing the emission from the automobile.
- Thought the stresses and strain intensity induced in the Connecting Rod made up Carbon Fiber is more than that induced in the Stainless Steel, but with the advancement in technology in the field of carbon fiber more higher Strength Carbon Fiber will be there in the near future for automobile industry.
- Thought the cost factor and time factor in the manufacturing of components by Carbon

Fiber in more at present time as compare to manufacturing by Stainless Steel and Aluminium Alloy, but mass production will greatly reduce the cost incurred and also time occurred will also reduce with the advancement in technology.

Hence at last in can be concluded that Carbon Fiber are the future material that can be used for the manufacturing of Connecting Rod, for being lighter and comparable strength with that of Stainless Steel and Aluminium Alloy.

## REFERENCES

1. *Pro/ENGINEER Wildfire 4.0 manual.*
2. *ANSYS WORKBENCH 13 manual.*
3. G.M Sayeed Ahmed, SirajuddinElyasKhany , Syed HamzaShareef “DESIGN, FABRICATION AND ANALYSIS OF A CONNECTING ROD WITH ALUMINUM ALLOYS AND CARBON FIBER”*International Journal of Innovative Research in Science, Engineering and Technology, ISSN: 2319-8753, Vol. 3, Issue 10, October 2014.*
4. Nikhil U.Thakare, Nitin D. Bhusale, Rahul P.Shinde, Mahesh M.Patil “FINITE ELEMENT ANALYSIS OF CONNECTING ROD USING ANSYS” *Proceedings of Third IRF International Conference on 8th February 2015, Cochin, India, ISBN: 978-93-84209-88-9.*
5. Prof. N.P.Doshi, 1 Prof. N.K.Ingole “ANALYSIS OF CONNECTING ROD USING ANALYTICAL AND FINITE ELEMENT METHOD” *INTERNATIONAL JOURNAL OF MODERN ENGINEERING RESEARCH” (IJMER) www.ijmer.com Vol.3, Issue.1, Jan-Feb. 2013, ISSN: 2249-6645.*
6. Kuldeep B, Arun L.R, Mohammed Faheem “ANALYSIS AND OPTIMIZATION OF CONNECTING ROD USING ALFASiC COMPOSITES”, *ISSN: 2319-875, International Journal of Innovative Research in Science, Engineering and Technology, Vol. 2, Issue 6, June 2013.*
7. Priyank D. Toliya, Ravi C. Trivedi, Prof. Nikhil J. Chotai “DESIGN AND FINITE ELEMENT ANALYSIS OF ALUMINIUM-6351 CONNECTING ROD” *Volume/Issue: Vol.2 - Issue 5 (May - 2013), e-ISSN: 2278-0181.*
8. Prof. Vivek C. Pathade , Dr. Dilip S. Ingole “STRESS ANALYSIS OF I.C.ENGINE CONNECTING ROD BY FEM AND PHOTOELASTICITY” *IOSR Journal of Mechanical and Civil Engineering (IOSR-JMCE) e-ISSN: 2278-1684 Volume 6, Issue 1 (Mar. - Apr. 2013), PP 117-125.*
9. Aniket B. Phatangare, Prof. M.S. Mhaske, Prof. S.B.Belkar, SwapnilKulkarni “USING FINITE ELEMENT ANALYSIS FOR DETERMINING FATIGUE LIFE OF CONNECTING ROD AS USED IN A MOTOR-BIKE” *International Journal of Advanced Engineering Research and Studies E-ISSN: 2249–8974.*
10. P S Shenoy and A Fatemi, “DYNAMIC ANALYSIS OF LAODS AND STRESSES IN CONNECTING”, *Proc.IMEchE Vol. 220 Part C: J. Mechanical Engineering Science.*
11. Ram Bansal “DYNAMIC SIMULATION OF A CONNECTING ROD MADE OF ALUMINIUM ALLOY USING FINITE ELEMENT ANALYSIS APPROACH” *IOSR Journal of Mechanical and Civil Engineering (IOSR-JMCE) e-ISSN: 2278-1684 Volume 5, Issue 2 (Jan. - Feb. 2013), PP 01-05.*
12. AbhinavGautam, K PriyaAjit “STATIC STRESS ANALYSIS OF CONNECTING ROD USING FINITE ELEMENT APPROACH” *IOSR Journal of Mechanical and Civil Engineering (IOSR-JMCE) e-ISSN: 2278-1684,p-ISSN: 2320-334X, Volume 10, Issue 1 (Nov. - Dec. 2013), PP 47-51.*
13. S. Shaari, M.M. Rahman, M.M. Noor, K. Kadirgama and A.K. Amirruddin “DESIGN OF CONNECTING ROD OF INTERNAL COMBUSTION ENGINE: ATOPOLOGY OPTIMIZATION APPROACHM” *National Conference in Mechanical Engineering Research and Postgraduate Studies (2nd NCMER 2010)3-4 December 2010, pp.155-166.*
14. Bhuptani K. M “STRUCTURAL ANALYSIS OF BUSH BEARING FOR SMALL END CONNECTING ROD USING “PROMECHANICA” *ISSN 0975 – 668X\ NOV 12 TO OCT 13 \ VOLUME – 02. 2344-02.*