

Performance Enhancement of Three Phase Squirrel Cage Induction Motor using BFOA

M.Elakkiya¹, D.Muralidharan²

¹PG Student, Power Systems Engineering, Department of EEE, V.S.B. Engineering College, Karur - 639111, India

²Assistant Professor, Department of EEE, V.S.B. Engineering College, Karur - 639111, India

elakkiya.kavin@gmail.com, dmuralidharan20@gmail.com

Abstract—This paper describes an Intelligent Bio-inspired optimization technique to minimize the square of errors in the parameters of an induction motor. The torque ripples and speed error would degrade the performance of the machine. In order to enhance the performance parameters of cage rotor type induction motor, the speed error and torque ripples should be minimized. This can be achieved by tuning the gain parameters in PI controllers. Hence, this research work focuses on the new optimization technique called Bacterial Foraging optimization Algorithm (BFOA). Here, Bacterial Foraging optimization (BFO) is used for efficiently tuning the derivative free Proportional Integral (PI) controller to an optimum value. This algorithm is used for tuning the speed controller, flux controller and torque controller to achieve the desired control performance. Hence the machine can run at reference speed under dynamically varying conditions. Also the peak overshoot, undershoot and settling time can be minimized. Moreover, simulation results are given clearly by using MATLAB and the hardware implementation will be the future work.

Keywords— Bacterial foraging optimization, PI Controller, Squirrel cage Induction motor, Sensorless speed estimation, chemotaxis, swarming, dispersal.

INTRODUCTION

Three-phase induction motors are widely used in industrial, domestic as well as commercial applications [6]. Especially, squirrel cage rotor type is used because of its advantages such as simple and rugged design, less maintenance and low cost. But in the other hand, controlling of speed is one of major difficult task in case of AC induction motor. Therefore to improve the performance of the machine is very essential, also controlling the speed is very important. For controlling purpose of AC motors, the two methods are:

- Field oriented control
- Direct torque control

In Field Oriented Control or vector control scheme, torque and speed control is achieved by decoupling of the stator components. But still there is complexity in implementation and also it requires necessary coordinate transformations. These drawbacks are overcome by the introduction of Direct Torque Control (DTC) scheme for AC motors. In this stator resistance is only required for the estimation of torque and flux and there would be very fast dynamic response to torque. Here decoupling between the stator flux component can be achieved by directly controlling the magnitude of the stator flux. The stator voltage measurements should have as low offset error as possible in order to minimize the flux estimation error. Hence, the stator voltages are usually estimated from the measured DC intermediate circuit voltage. Hence PI controllers are used to keep the measured components such as torque or flux at their reference values. The classical PI (proportional, integral) control method is mostly used in motor control system to eliminate the forced oscillations and steady state error. But they are slow adapting to parameter variations, load disturbances and speed changes. There are several design techniques for PI controllers are found in the literature, starting from Ziegler Nichols method to modern ones (ANN, Fuzzy, evolutionary programming, sliding mode, etc). Thus, many intelligent techniques were used for tuning the controllers. In genetic algorithm and particle swarm optimization, there was premature convergence which degrades the performance of the system.

In this paper, an evolutionary optimization technique called bacterial foraging optimization algorithm has been proposed for making efficient tuning of PI controller. This BFO undergoes the following steps such as chemotaxis, swarming, reproduction, elimination and dispersal. There are two characteristics such as swimming and tumbling which is used for the movement of bacteria. In next step it gives signal to the neighboring bacteria to form a swarm (group). The healthier bacteria reach the reproduction stage and get split into two

groups. The least healthy bacterium can be eliminated and dispersed. Several steps were done to find the best solution. Hence, this BFO technique enhances the search capability and also it overcomes the premature convergence. Thus error minimization can be done for the controllers using optimal tuning of gain parameters.

ESTIMATION OF INDUCTION MOTOR PARAMETERS

For estimation of induction motor parameters Sensorless speed estimation is used. The conventional speed sensor is replaced by Sensorless speed estimation to achieve more economical control. In order to minimize the torque ripples, Sensorless estimation of speed, torque, flux and theta are calculated by using stator current. This Sensorless speed estimation improves reliability and decrease the maintenance requirements. The torque ripples can be minimized by the following estimation of induction motor parameters. It can be able to control directly the stator flux and the electromagnetic torque by directly controlling the voltage and current. Park's Transformation for stator voltage and current is done to reduce the machine complexity due to the varying angle and time for inductance terms. Also the three phase to single phase conversion makes the estimation quiet easy. Consider the following current equation in d-q terms from abc is obtained using the equation,

$$I_d = \frac{2}{3} \left(I_a \sin \omega t + I_b \sin \left(\omega t - \frac{2\pi}{3} \right) + I_c \sin \left(\omega t + \frac{2\pi}{3} \right) \right) \quad (1)$$

$$I_q = \frac{2}{3} \left(I_a \cos \omega t + I_b \cos \left(\omega t - \frac{2\pi}{3} \right) + I_c \cos \left(\omega t + \frac{2\pi}{3} \right) \right) \quad (2)$$

$$I_0 = \frac{1}{3} (I_a + I_b + I_c) \quad (3)$$

Similarly the voltage equations are,

$$V_d = \frac{2}{3} \left(V_a \sin \omega t + V_b \sin \left(\omega t - \frac{2\pi}{3} \right) + V_c \sin \left(\omega t + \frac{2\pi}{3} \right) \right) \quad (4)$$

$$V_q = \frac{2}{3} \left(V_a \cos \omega t + V_b \cos \left(\omega t - \frac{2\pi}{3} \right) + V_c \cos \left(\omega t + \frac{2\pi}{3} \right) \right) \quad (5)$$

$$V_0 = \frac{1}{3} (V_a + V_b + V_c) \quad (6)$$

The stator flux estimation is given as,

$$\phi_{sd} = \int (V_{sd} - R_s \cdot I_{sd}) dt \quad (7)$$

$$\phi_{sq} = \int (V_{sq} - R_s \cdot I_{sq}) dt \quad (8)$$

Where R_s is the stator resistance and it can be obtained by calculating the rotor resistance. From the d-axis and q-axis stator flux component, the magnitude of stator flux is $\sqrt{\phi_{sd}^2 + \phi_{sq}^2}$ obtained and the Torque equation is,

$$T_e = \frac{3}{2} P (\phi_{sd} \cdot I_{sq} - \phi_{sq} \cdot I_{sd}) \quad (9)$$

Where T_e is the electromagnetic torque, P is the number of poles. Then the stator current for d-axis and q-axis is denoted as I_{sd} and I_{sq} respectively. Similarly stator voltage for d-axis and q-axis is denoted as V_{sd} and V_{sq} respectively. Because of the Sensorless speed estimation, Electrical speed is obtained by calculating the torque, current and voltage. Then the rotor flux is obtained by $\frac{L_m}{L_r}$ times the stator flux. The rotor angle is given as,

$$\theta = \tan^{-1} \left(\frac{\phi_{sq}}{\phi_{sd}} \right) \quad (10)$$

Estimated speed is given as,

$$N_e = \frac{N_r(\text{field}) - S}{(\text{rotor flux})^2} \quad (11)$$

The speed of rotor field and slip equation is,

$$N_{r(\text{field})} = \phi_{rd} \cdot \phi_{r\beta} - \phi_{rq} \cdot \phi_{r\alpha} \quad (12)$$

$$S = \frac{3}{2} T_e R_r / 2 \quad (13)$$

CONTROLLER USING OPTIMIZATION TECHNIQUES

a) PI CONTROLLER

The Proportional and Integral (PI) controller is widely used in speed control of motor drives. The proportional controller improves the steady state tracking accuracy and load disturbance signal rejection. It also decreases the sensitivity of the system to parameter variations. The proportional control is not used alone because it produces constant steady state error. Hence Proportional plus Integral (PI) controller will eliminate forced oscillations i.e. peak overshoot and undershoot and also the steady state error. In PI controller,

$$U(t) = K_p e(t) + K_i \int e(t) dt \quad (14)$$

Where K_p - Proportional gain, K_i - Integral gain.

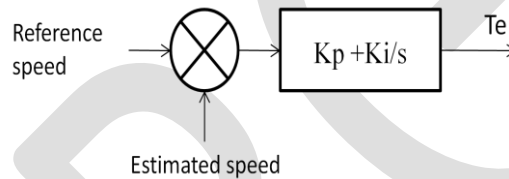

Fig 1. Classical PI controller

The Fig 1 shows the classical PI controller. The speed controller compares the actual motor speed with the corresponding reference speed and it outputs the electromagnetic torque reference. Tuning is the adjustment of control/gain parameters (proportional, integral) to the optimum values for the desired control response. Ziegler–Nichols method is one of the tuning methods for controllers. Since it has a major drawback is very aggressive tuning.

b) PI CONTROLLER WITH BFOA

The tuning of PI controller gain parameters is one of the difficult tasks. For efficient tuning, Bacterial foraging optimization algorithm is used to select the proportional (K_p) and integral (K_i) gain constant. Consider the speed controller block which is tuning the gain parameters K_p and K_i values.

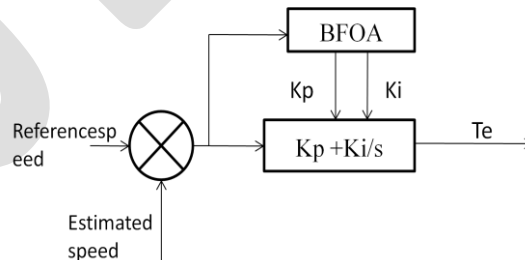

Fig 2. PI controller with BFOA

The following block diagram shows the controller block with BFOA:

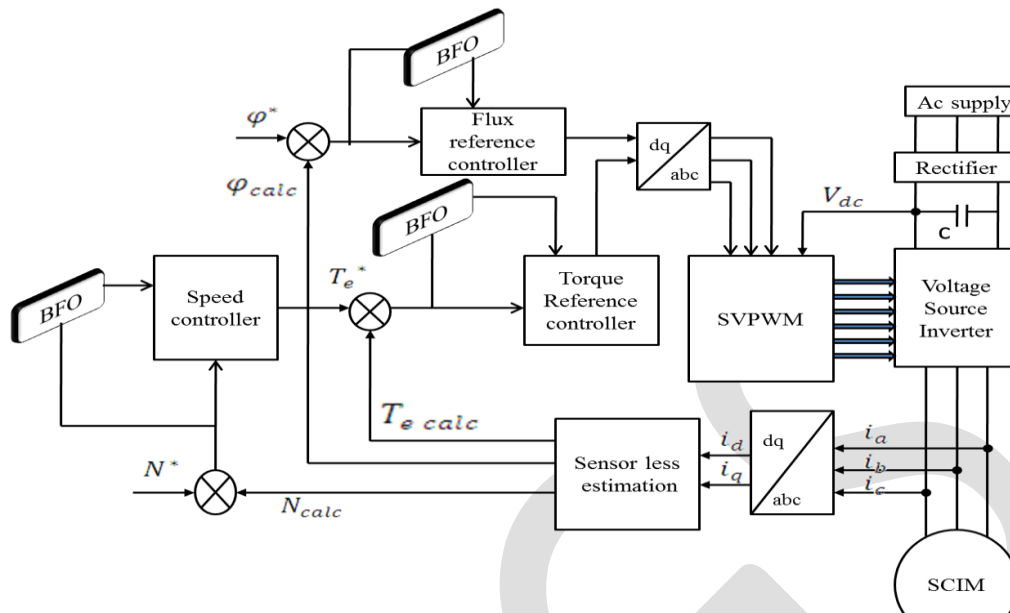

Fig 3. Overall block diagram with BFOA tuning

BACTERIAL FORAGING OPTIMIZATION ALGORITHM

The following are the steps in BFOA

1. CHEMOTAXIS

In this step, process of swimming and tumbling of bacteria's such as E.Coli for searching the food location is done using flagella. Through swimming action, the bacteria can move in a specified direction and during tumbling it can modify the direction of search. Then, in computational chemotaxis, the movement of the bacterium is given by the following equation,

$$\theta(j + 1, k, l) = \theta(j, k, l) + c(i) \left(\frac{\Delta(i)}{\sqrt{\Delta t(i) \Delta(i)}} \right) \quad (15)$$

2. SWARMING

In this step, after the success in the direction of the best food location, the bacterium which has the knowledge about the optimum path to the food source will attempt to communicate to other bacteria by using a magnetism signal. If the attractant between the cells is high and very deep, the cells will have a strong tendency to swarm. The cell-to-cell interaction is given by the following function,

$$J_{cc}(\theta, P(j, k, l)) = \sum_{i=1}^s J_{cc}(\theta, \theta_i(j, k, l)) \quad (16)$$

3. REPRODUCTION

The least healthy bacteria eventually die while each of the healthier bacteria split into two bacteria's, which remains in the same place. This keeps the swarm size constant; the bacteria which did not split will die.

4. ELIMINATION AND DISPERSAL

According to the preset probability, an individual bacterium which is selected for elimination is replaced by a new bacterium in random new location within optimized domain. The bacterium is dispersed to a new area, which destroys the chemotaxis, but the bacteria may find the more abundant areas. This mimics the real-world process of the bacteria can be dispersed to new location. Thus the step size of each bacterium is the main determining factor for both the speed of convergence and error in final output.

The following points give the advantages of using this optimization algorithm: 1) Control and Accuracy is high compared to other methods. 2) Minimal torque ripples response in comparing with other control circuit. 3) Auto tuning is introduced. 4) Better dc link voltage response. 5) Good performance of the system under load and speed varying conditions.

SIMULATION AND RESULTS

The simulation is carried out on the three phase squirrel cage induction motor using MATLAB is shown in fig 4. The speed output is given as feedback to the workspace for adjusting the gain parameters in controller using BFOA.

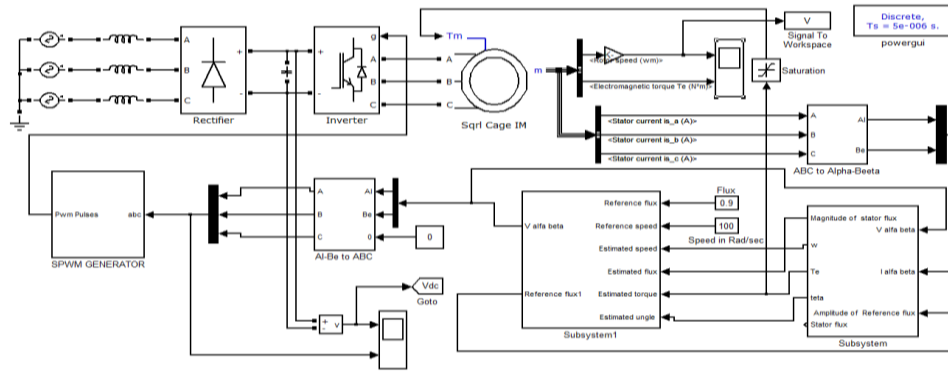

Fig 4. Simulink block with BFOA

During the tuning of PI Controller using BFO Algorithm, there is several trials for speed waveform with different values of gain parameters. Consider the following result, which shows the improvement in settling time period by each trial.

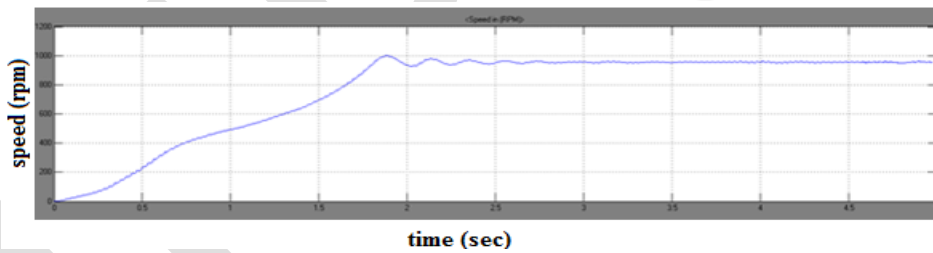

Fig 5(a) speed during trial 1 ($T_s = 1.8$ sec)

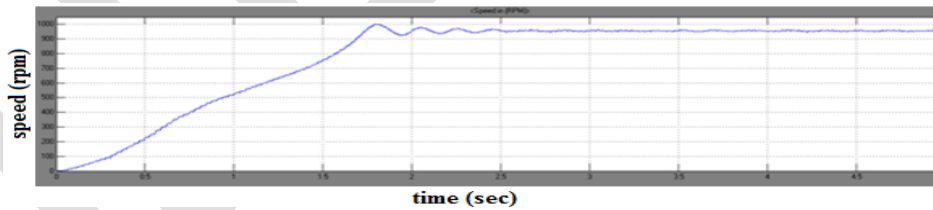

Fig 5(b) speed during trial 2 ($T_s = 1.7$ sec)

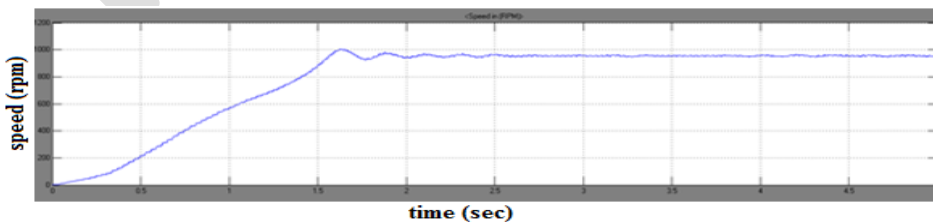

Fig 5(c) speed during trial 3 ($T_s = 1.6$ sec)

Thus there is improvement in settling time (T_s) by each trial from the fig 5(a) to 5(c). Also there is minimum overshoot in the torque waveforms as shown in the fig 6(a) to 6(c).

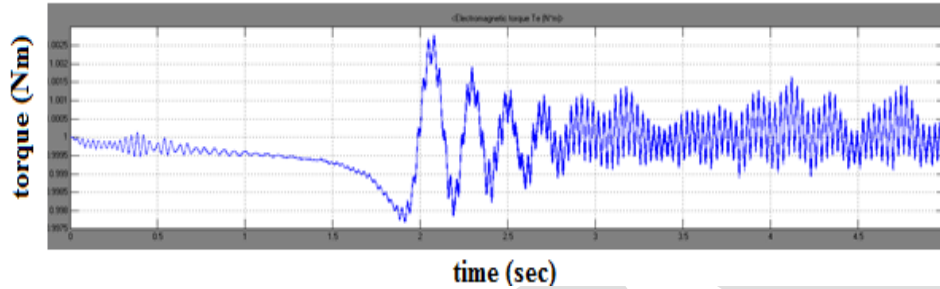

Fig 6(a) torque during trial 1

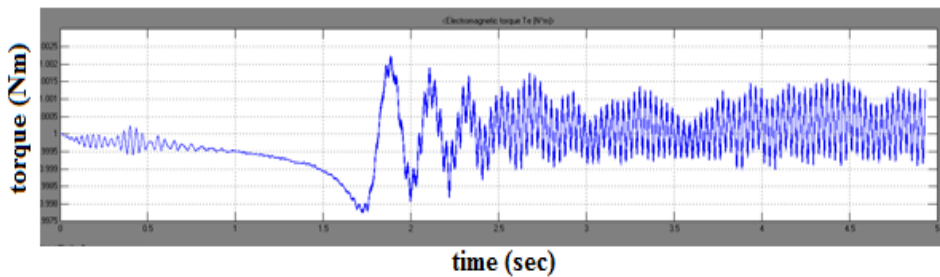

Fig 6(b) torque during trial 2

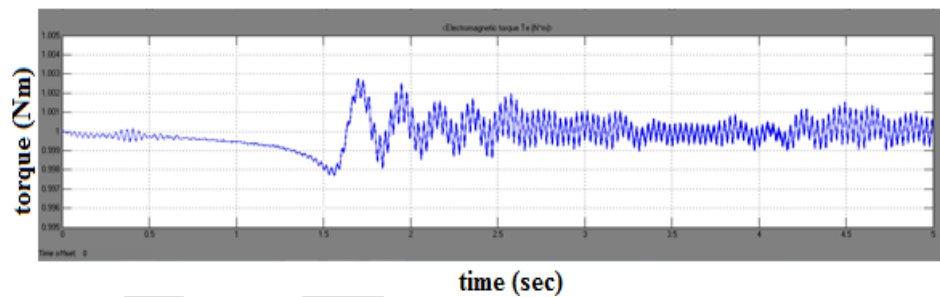

Fig 6(c) torque during trial 3

From the Simulink controller block fig 4, the reference value of 0.9 is set. The stator fluxes for d and q axis is given in this waveform. To achieve the desired performance, the rotor flux should reach the reference flux. This is shown in the fig 8. Then the dc link voltage reaches its constant voltage in fig 9.

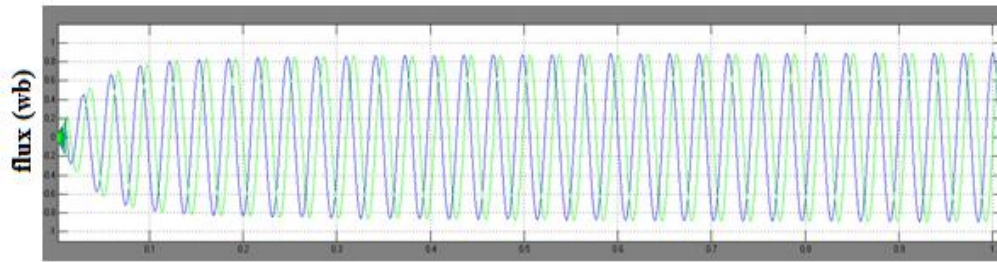

Fig 7. Stator reference flux

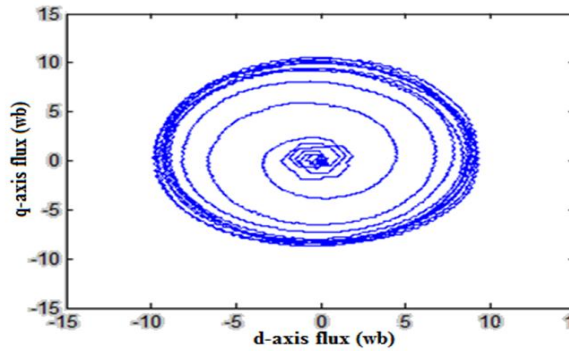

Fig 8. Rotor flux

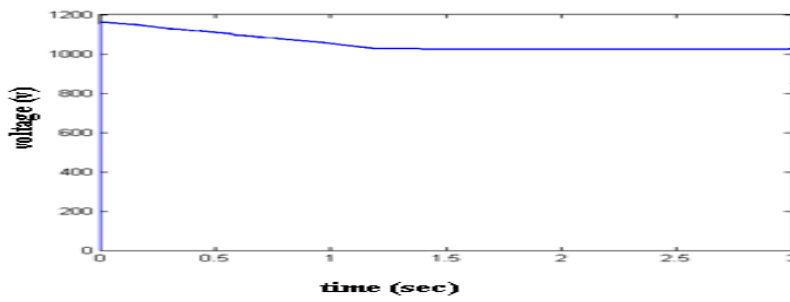

Fig 9. DC link voltage

Comparison of speed waveform with and without BFOA is shown below:

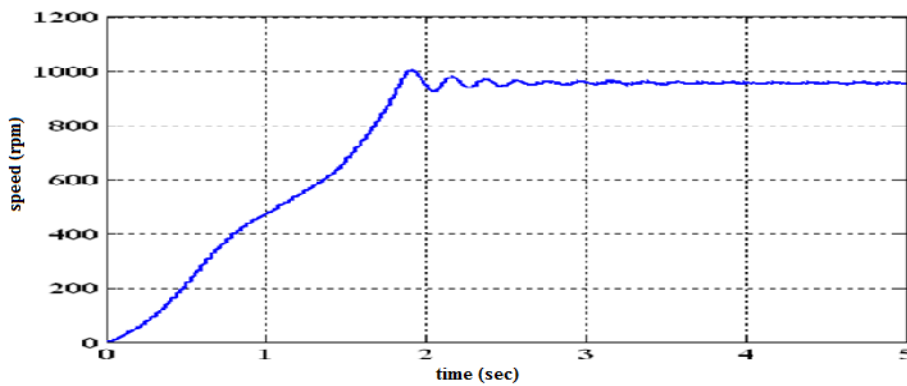

Fig 10(a) normal speed without BFOA

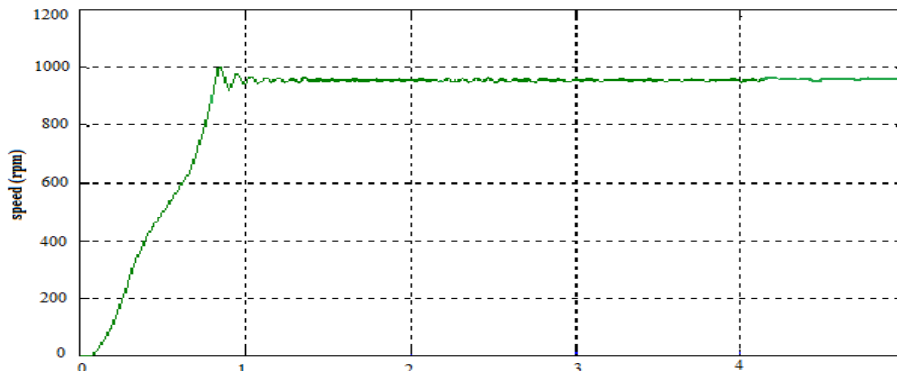

Fig 10(b) optimized speed with BFOA

Thus from the comparison of speed with and without BFOA, the optimized result is obtained at T_s (settling time) equal to 0.8 seconds. Hence this shows the improvement in performance parameters.

SPECIFICATIONS

Power	4 KW
Voltage	400 V
Current	10 A
Frequency	50 Hz
Rated Speed	1500 rpm
Stator Resistance	0.5 ohm
Stator Inductance	0.0415 H
Rotor Resistance	0.25 ohm
Rotor Inductance	0.0413
Mutual Inductance	0.0403
Capacitor	1200 μ f
Pole pairs	2
K_p, K_i (speed controller)	5, 100
K_p, K_i (torque controller)	20, 10
K_p, K_i (flux controller)	20, 70
K_p, K_i (limit)	5, 100
K_p, K_i (optimized)	3.3, 80

In BFO Algorithm, the following are the considerations: Number of bacteria = 5, Number of chemotaxis step = 3, Number of swim length = 2, Number of elimination and dispersal = 2 and probability of elimination and dispersal is 0.25. The cost functions are to reduce the peak overshoot and settling time. Then the saturation limit in controller module is given as lower limit zero to upper limit 12. Thus Overall system performance fully depend on the DC link voltage response, hence the Peak Over Shoot, Peak Under Shoot, Settling Time can be minimized.

CONCLUSION

In this paper, a new bio inspired optimization technique is presented. The Direct torque controlled space vector modulated VSI is fed with the induction machine to improve the performance of the system. Thus the closed loop control of induction motor with BFOA technique gives the minimum torque ripples and the machine can run at reference speed under different loading conditions. Hence the peak overshoot, undershoot and settling time can be minimized by optimum tuning of gain parameters in PI controllers using Bacterial foraging algorithm. During the running condition, the rotor flux reaches the reference circular frame to achieve the good performance of the system. This can be verified with the various results of the Simulink block using MATLAB.

REFERENCES:

- [1] M. Hafeez, M. NasirUddin ,NasrudinAbd. Rahim, Hew Wooi Ping, “Self-Tuned NFC and Adaptive Torque Hysteresis-Based DTC Scheme for IM Drive”, IEEE transactions on industrial applications, vol. 50, no. 2, march/april 2014.
- [2] S. V. Jadhav, J. Srikanth, and B. N. Chaudhari, “Intelligent controllers applied to SVM-DTC based induction motor drives: A comparative study,” in Proc. IEEE Power India Int. Joint Conf. Power Electron., Drives Energy Syst., Dec. 2010, pp. 1–8.121, Apr. 2011.
- [3] V.P.Sakthivel, S.Subramanian “Using MPSO Algorithm to Optimize Three-Phase Squirrel Cage Induction Motor design” IEEE, 2011.
- [4] O.S. EI-Laban , H.A. Abdel Fattah, H.M.Emara, and A.F.Sakr, “Particle swarm optimized direct torque control of induction motors”. IEEE Trans, 2006.
- [5] T. VamseeKiran and N. Renuka Devi , “Particle swarm optimization based direct torque control (DTC) of induction motor” Vol. 2, Issue 7, July 2013.
- [6] AhmudIwanSolihin, Lee Fook Tack and MoeyLeapKean. “Tuning of PID controller using particle swarm optimization” (PSO). 2011.
- [7] S. Nomura, T. Shintomi, S. Akita, T. Nitta, R. Shimada, and S. Meguro, “Technical and cost evaluation on SMES for electric power compensation,” IEEE Trans. Appl. Supercond., vol. 20, no. 3, pp. 1373– 1378, Jun. 2010.
- [8] Ping Guo, Dagui Huang, DaiweiFeng, Wenzheng Yu and Hailong Zhang is “Optimized Design of Induction Motor Parameters Based on PSO (Particle Swarm Optimization)”, IEEE, 2012.
- [9] FlahAyman and SbitaLassaad is “BFO control tuning of a PMSM high speed drive”, IEEE, 2012.
- [10] Kevin M. Passino “Biomimicry of Bacterial Foraging for Distributed Optimization and Control”, IEEE Control systems, June 2002.
- [11] M. Tripathy and S. Mishra, “Bacteria Foraging-Based Solution to Optimize Both Real Power Loss and Voltage Stability Limit”, IEEE transactions on power systems, vol. 22, no. 1, February 2007.
- [12] Xiabo Shi, Wei-xing Lin, “PID Control Based on an Improved Cooperative Particle Swarm-Bacterial Hybrid Optimization Algorithm for the Induction Motor” AISS, Volume4, Number21, Nov 2012