

ANALYSIS & DESIGNING OF E-SHAPE MICROSTRIP ANTENNA WITH SLOT FOR ISM BAND

VIDYA DESHMUKH & ABHILASHA MISHRA

Department of Electronics & Telecommunication Engineering, M.I.T. College of Engineering,
Aurangabad, Maharashtra, India

ABSTRACT

In this paper, E-shaped microstrip patch antenna with slot is proposed for ISM BAND application. The proposed antenna project is about microstrip antenna with meandered ground plane. The design adopts contemporary techniques; coaxial probe feeding, E-shape patch structure and slotted patch. The composite effect of introducing the proposed patch, offer a low profile, broadband, and low cross-polarization level. The results for the return loss, VSWR, gain and co-and cross-polarization patterns are presented. The antenna operating the band of 2.40-2.48GHz shows an comparative impedance bandwidth and its gain table for various shape arrangement. The entire project is design and simulated in an soft HFSS software.

KEYWORDS: E-Shape MSA with Slot, Co-Axial Feed, Return Loss, VSWR, an Soft HFSS V.11

INTRODUCTION

There is always been an ever growing demand to have smaller, low cost, and compact wireless systems. In order to reduce the overall size of the wireless systems, there is always been a need to have small and compact antennas. A small size antenna was highly desirable because the size of communication devices was decreased. The antenna should be designed in planar form to match the rapid development in wireless communication applications. Narrow bandwidth is a serious limitation of these microstrip patch antennas. The other drawbacks of basic microstrip structures include low power handling capability, loss, half plane radiation and limitation on the maximum gain. Different techniques are used to overcome this narrow bandwidth limitation. These techniques include increasing the thickness of the dielectric substrate, decreasing dielectric constant and using parasitic patches[1]. However, research is still continuing today to overcome some of these disadvantages. This paper, introduces an analysis and designing of E-shape microstrip patch antenna with slots for wireless communication applications. The E-shape of microstrip patch antenna with slots as shown in Figure 1.

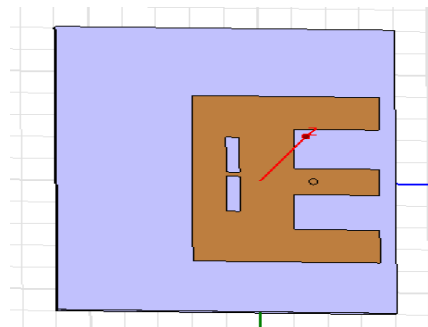

Figure 1: E-Shaped Microstrip Patch Antenna with Slots

ANTENNA DESIGN & STRUCTURE

In this paper, the E-shape microstrip patch antenna with slots has been designed with over all dimensions $W(\text{mm}) \times L(\text{mm})$. The designing of E-shaped microstrip patch antenna with slots, the resonant frequency $f_r = 2.4\text{GHz}$ and the dielectric substrate glass epoxy is used for fabrication. The dielectric constant of the substrate is $\epsilon_r = 4.2$ and thickness of the substrate $h = 1.59\text{mm}$ to design the E-shaped microstrip patch antenna with slots. The width and length of the microstrip antenna are determine as follows

$$W = \frac{1}{2 f_r \sqrt{\mu_0 \epsilon_0}} \sqrt{\frac{2}{\epsilon_r + 1}} = \frac{v_0}{2 f_r} \sqrt{\frac{2}{\epsilon_r + 1}} \quad (1)$$

Where v_0 is the free-space velocity of light.

$$\epsilon_{r\text{eff}} = \frac{\epsilon_r + 1}{2} + \frac{\epsilon_r - 1}{2} \left[1 + 12 \frac{h}{W} \right]^{-1/2} \quad (2)$$

Where the dimensions of the patch along its length have been extended on each end by a distance ΔL , which is a function of the effective dielectric constant $\epsilon_{r\text{eff}}$ and the width to-height ratio (W/h), and the normalized extension of the length, is

$$\Delta L = 0.412 h \frac{(\epsilon_{r\text{eff}} + 0.3) \left(\frac{W}{h} + 0.264 \right)}{(\epsilon_{r\text{eff}} - 0.258) \left(\frac{W}{h} + 0.8 \right)} \quad (3)$$

The actual length of the patch (L) can be determine as

$$L = \frac{1}{2 f_r \sqrt{\epsilon_{r\text{eff}}}} \sqrt{\mu_0 \epsilon_0} - 2 \Delta L \quad (4)$$

Into the rectangular microstrip antenna, it becomes an E-shaped patch. The E-shaped microstrip patch antenna is simpler in construction. The geometry of E-shape microstrip antenna with slots as shown in figure 2.

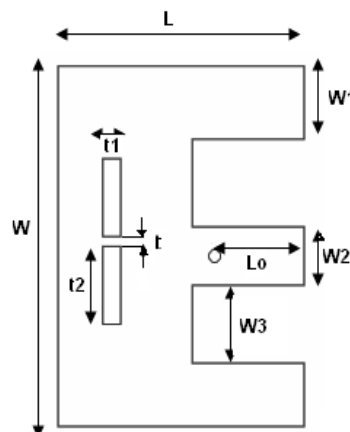

Figure 2: Geometry of E-Shape Microstrip Antenna with Slots

The dimensions of the E-shape microstrip patch antenna with slots at operating frequency 2.40GHz as shown in Table 1.

Table 1: Dimensions of Antenna

Frequency fr	2.40GHz
Length (L)	27.5mm
Width(W)	37mm
Height (h)	1.59mm
W1	7.5mm
W2	6mm
L0	9mm
T1	2mm
T2	8mm
Dielectric (ϵ_r)	4.2

EXPERIMENTAL RESULTS

This paper will present the design of the Microstrip antenna, its development and performance based on the measured results. Finite element method(FEM) software “High Frequency Structure Simulator” HFSS 11.0 [14]. Ensemble was found to give more accurate results for the input S-parameters. Unfortunately, it does not calculate radiation patterns accurately near the horizontal plane. For this reason, HFSS was used for far field calculations. The E-shaped Microstrip antenna with slots with probe feed using An soft HFSS as shown in figure 3.



Figure 3: Fabricated E-Shaped Microstrip Antenna with Slots

Firstly, the Return Loss (-16.59dB), Bandwidth (80MHz) and VSWR (1.34) at Operating Frequency 2.40 GHz for the E-shaped Microstrip Antenna with Slots using HESS Software Determine as shown in Figure 4(a) & 4(b). on the other Hand, Measured Return Loss (-19.59dB), Bandwidth (100MHz) and VSWR (1.22) at Operating Frequency 2.40GHz Network Analyzer Determine as shown in Figure 5(a) & 5(b) also Figure 6(a) & 6(b) Simulated & measured result of return loss & VSWR.

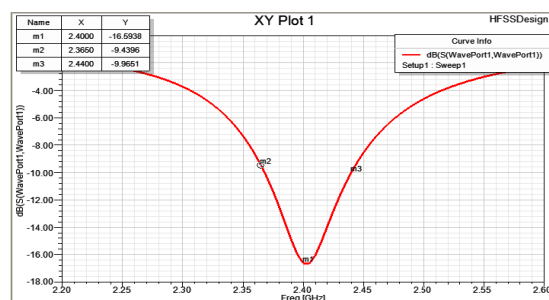

Figure 4(a): S11 (Return Loss)

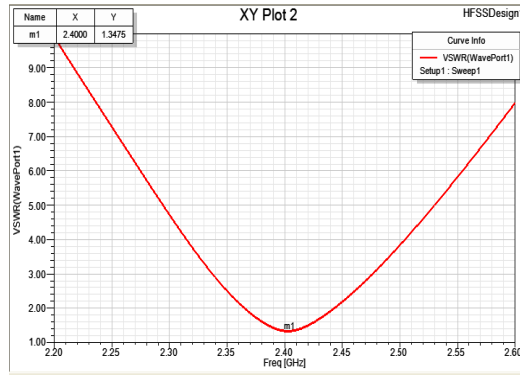

Figure 4(b): VSWR

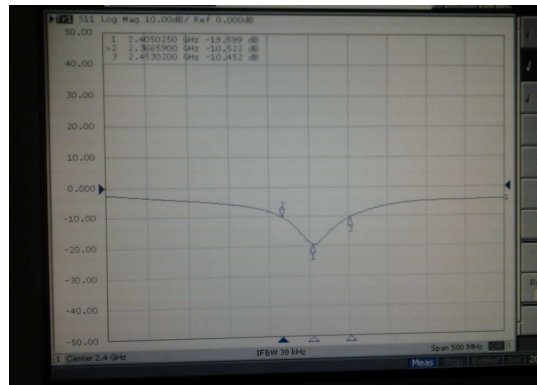

Figure 5(a): S11 (Return Loss)



Figure 5(b): VSWR

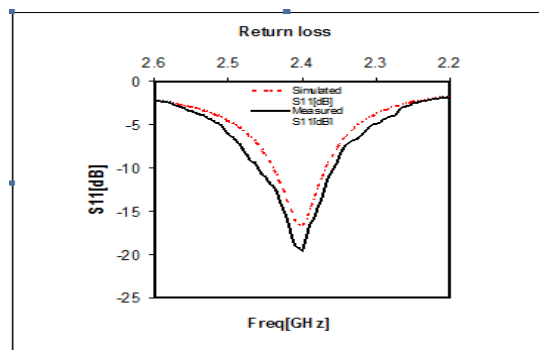

Figure 6(a): Simulated & Measured Result of Return loss

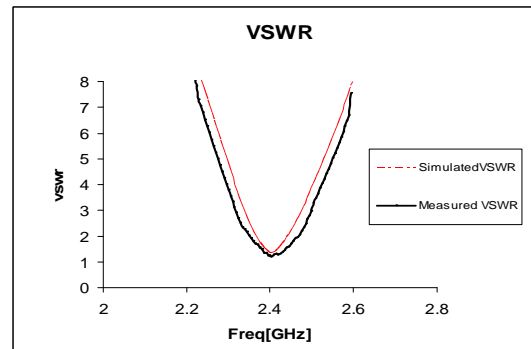

Figure 6(b): Simulated & Measured Result of VSWR

A probe, which may be an extension of the inner conductor of a coaxial feed line, feeds the patch. The parameters that characterize the antenna are the patch length and width, the height of the patch, the length of the middle wing, the widths of the wings and the location of the coaxial probe. The centre wing resonates at a higher frequency.

CONCLUSIONS

This paper presents the designing and analysis of the E shaped antenna with slots using HFSS software and Finite element method (FEM) respectively. In this paper, the simulated & measured values of the return loss and VSWR are shown. While making antenna compact there should not be effect on antenna parameter. In this designing concept of simple patch antenna is described and then different techniques for size reduction of antenna are discussed. In this antenna the slots are introduced in the patch which affect the flow of current. Due to this current on radiating patch changes. From the results, we can say that the E-shaped microstrip antenna with slot gives the better results for return loss, impedance bandwidth and VSWR at operating frequency 2.40GHz. The effect of various slot parameters of E-shaped patch antenna are studied.

REFERENCES

1. Ramesh Garg, Prakash Bhartia, Inder Bahl and Apisak Ittipiboon, "Microstrip Antenna Design Hand Book," Artech House, Norwood, MA, 2001.
2. C. A. Balanis, Antenna Theory - Analysis and Design, John Wiley & Sons Inc., 1997
3. M. K. Verma, Sapna Verma, D. C. Dhukarya "Analysis and Designing of E-Shape Microstrip Patch Antenna for the Wireless Communication Systems" 2009 International Conference on Emerging Trends in Electronic and Photonic Devices & Systems (ELECTRO-2009)
4. S. I. Latif, Lotfollah Shafai and Satish Kumar Sharma, Member, IEEE "Bandwidth Enhancement and Size Reduction of Microstrip Slot Antennas" IEEE TRANSACTIONS ON ANTENNAS AND PROPAGATION, VOL. 53, NO. 3, MARCH 2005.
5. Yuehe Ge, Karu P. Esselle "E-Shaped Patch Antennas for High-Speed Wireless Networks" IEEE TRANSACTIONS ON ANTENNAS AND PROPAGATION, VOL. 52, NO. 12, DECEMBER 2004.
6. [Online] Available: <http://standards.ieee.org/catalog/olis/lanman.html>

APPENDICES

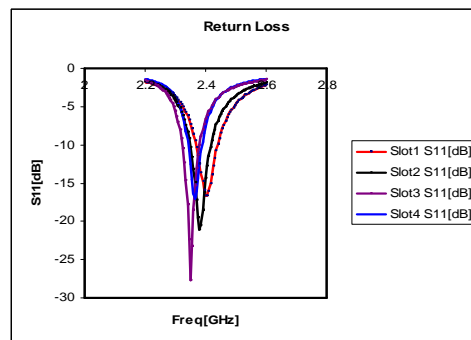

Figure 7(a): Effect of Slot on Return Loss When Position of X Constant & Y Varies

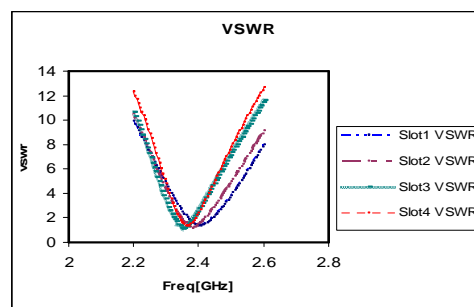

Figure 7(a): Effect of Slot on VSWR When Position of X Constant & Y Varies

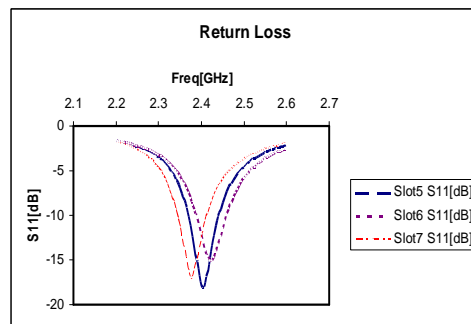

Figure 8(a): Effect of Slot on Return Loss When Position of Y Constant & X Varies

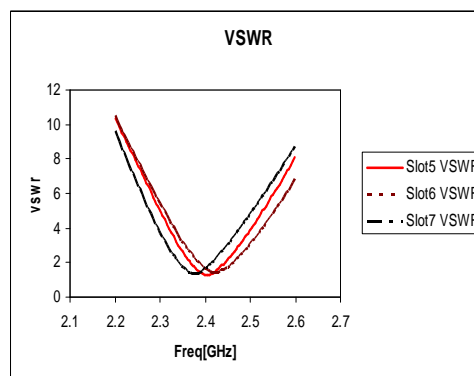
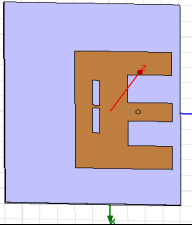
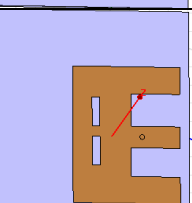

Figure 8(b): Effect of Slot on VSWR When Position of Y Constant & X Varies
Effect of Slot Dimensions on E-Patch

Table 2: Effect of Slot Dimensions on E-Patch

Sr. No.	E-Patch Figure	Change in Position of X&Y Axis Dimensions			Parameters of Antenna (RL, VSWR, Frequency, BW, Radiation Pattern)
		Slots	X	Y	
1		Slot1 Slot 2	-10 -1	-10 -10	F=2.40GHz S11=-16.59dB VSWR=1.34 Gain=1.34dB BW=80MHz
2		Slot1 Slot 2	-10 -1	-8 -8	F=2.38GHz S11=-21.12dB VSWR=1.19 Gain=1.33dB BW=60MHz
3		Slot1 Slot 2	-10 -1	-6 -6	F=2.35GHz S11=-27.67dB VSWR=1.09 Gain=1.34dB BW=55MHz
4		Slot1 Slot 2	-10 -1	-4 -4	F=2.34GHz S11=-17.67dB VSWR=1.32 Gain=1.26dB BW=50MHz
5		Slot1 Slot 2 (2mm)	-10 0	-10 -10	F=2.405GHz S11=-18.20dB VSWR=1.28 Gain=1.3dB BW=70MH
6		Slot1 Slot 2 (3mm)	-11 0	-10 -10	F=2.425GHz S11=-15.09dB VSWR=1.42 Gain=1.10dB BW=60MHz
7		Slot1 Slot 2 (4mm)	-12 1	-10 -10	F=2.425GHz S11=-15.09dB VSWR=1.42 Gain=1.10dB BW=70MHz

