

## MATHEMATICAL MODEL ANALYSIS AND CONTROL ALGORITHMS DESIGN BASED ON STATE FEEDBACK METHOD OF ROTARY INVERTED PENDULUM

IRFAN JAMIL<sup>1</sup>, REHAN JAMIL<sup>2</sup>, ZHAO JINQUAN<sup>3</sup>, RIZWAN JAMIL<sup>4</sup> & ABDUS SAMEE<sup>5</sup>

<sup>1,4</sup>College of Energy and Electrical Engineering Hohai University, Nanjing, China

<sup>2</sup>School of Physics & Electronic Information, Yunnan Normal University, Kunming, China

<sup>3</sup>Heavy Mechanical Complex (HMC-3) Taxila, Pakistan

<sup>5</sup>Chasma Center of Nuclear Training, PEAC, Islamabad, Pakistan

### ABSTRACT

XZ-II type rotary inverted pendulum is a typical mechatronic system; it completes real-time motion control using DSP motion controller and motor torque. In this paper, we recognize XZ-II rotational inverted pendulum and learn system composition, working principle, using method, precautions and software platform. We master how to build mathematical model and state feedback control method (pole assignment algorithm) of the one order rotational inverted pendulum system and finish simulation study of system using Matlab. In the end we grasp debugging method of the actual system, and finish online control of the one order rotational inverted pendulum system as well.

**KEYWORDS:** Rotational Inverted Pendulum, Mathematical Model, State Feedback, Simulation, Debugging

### INTRODUCTION

#### Rotary Inverted Pendulum

Inverted pendulum is typical multi-variable, nonlinear non-minimum-phase, unstable and underactuated system [1]-[5]. XZ-II rotary inverted pendulum system uses DSP as the controller, and it has independent ability to complete real-time control algorithms without the computer; it also can complete computer control by RS-232C serial communication interface, and on-line control algorithm can be debugged. DSP, power supply and motor drive are all installed in the chassis. The figure 1 shows the overall structure diagram of the system.

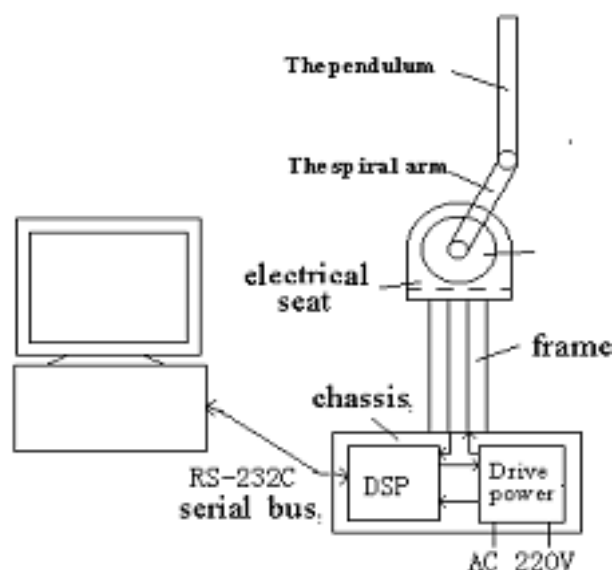
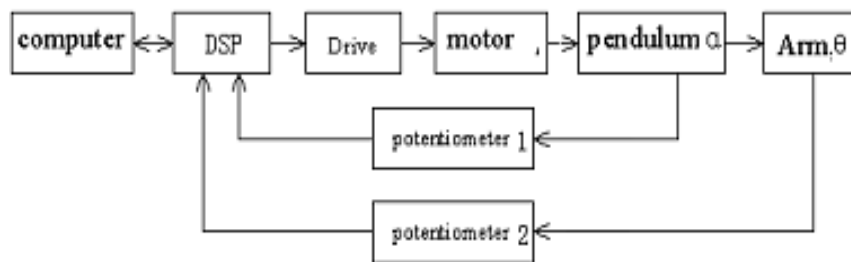


Figure 1: The Overall Structure Diagram of the XZ- Rotary Inverted Pendulum System

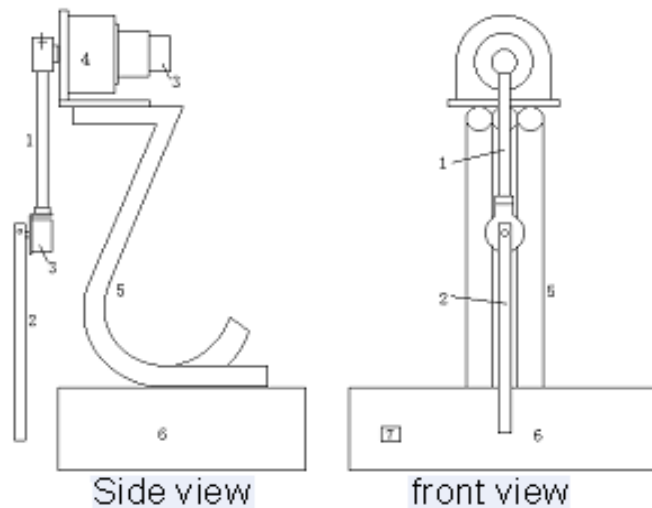
DSP controller is the core control device; it can complete some functions such as data transfer, A / D, D / A conversion, computation, data processing etc. The executing agency of system is the DC torque motor driven by a dedicated drive circuit; it can control motion of inverted pendulum. Measurement feedback components are the two potentiometers used measure the angle signal of the pendulum and arm. Drive power.

**Working Principle of the System**

The spiral arm is drive by the DC torque motor, and it can rotate around the vertical plane that is perpendicular to motor axis. The pendulum and spiral arm are connected by activity shaft axis of a potentiometer, and the pendulum can rotate around shaft axis in the vertical plane that is perpendicular to the spiral arm. The two angular signals displacement can be measured by the potentiometers (one is lead angle between the spiral arm and the vertical line, another is the relative angle between the spiral arm and the pendulum), and they as two outputs of system t are sent to DSP controller. The angular velocity signal can be obtained by the differential of the angular displacement, and then using some state feedback control algorithm to calculate the control law is provided to the drive circuit after transformed into voltage signal, the signal is used to drive DC torque motor, at last, the arm's movement is achieved by the pendulum rotation driven by motor, working principle is shown as following figure 2, 3.



**Figure 2: Structure Block Diagram of the XZ- Rotary Inverted Pendulum System**



- 1. The Spiral Arm 2. The Pendulum 3. Potentiometers
- 4. DC Torque Motor 5. Frame 6. Chassis 7. Power Switch

**Figure 3: Mechanical Structure Diagram of the XZ- Rotary Inverted Pendulum System**

**Introduction about Processing Software**

Running DSP.exe, following figures 4, 3 will appear. Through this dialog, we can set up and change all parameters except for parameters of “running mode”. Therefore “running mode” can be changed only when system is stopping, else accident may be happened.

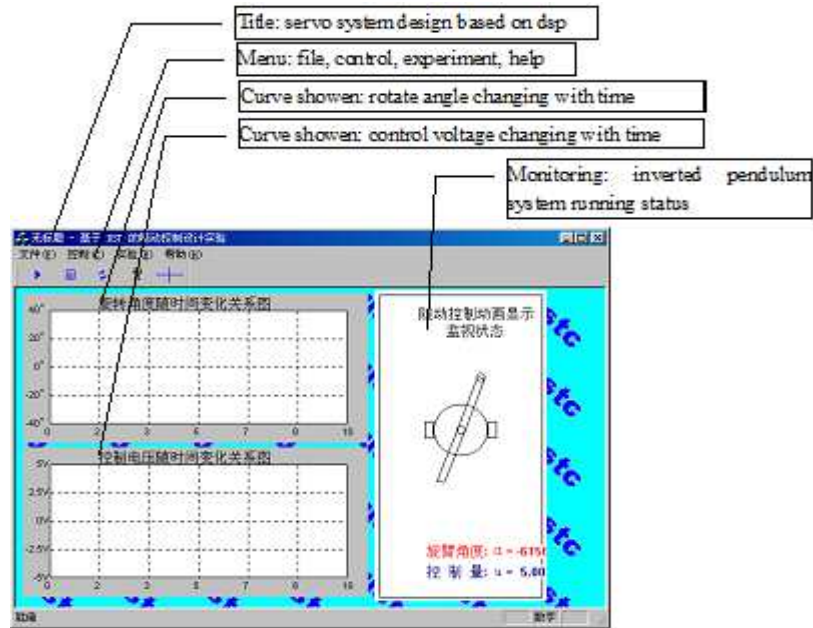


Figure 4: Main Interface of Processing Software

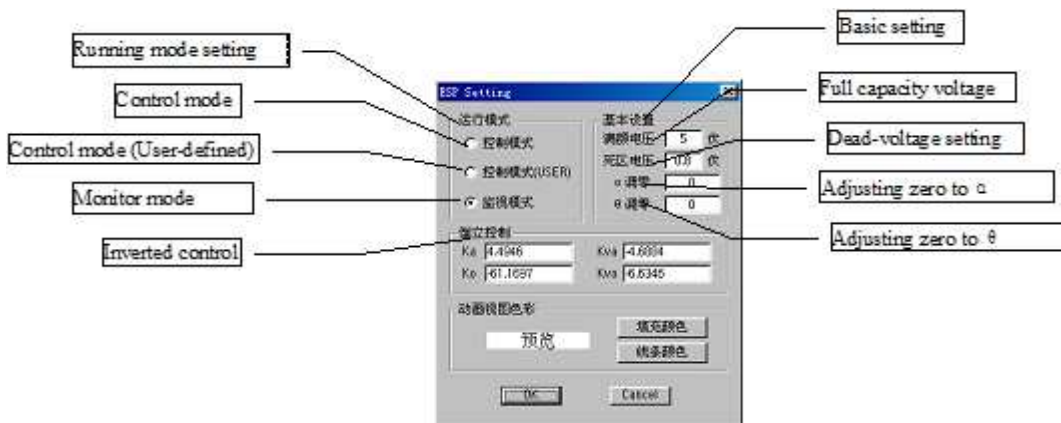


Figure 5: "Setting" Interface of Processing Software

Parameter settings include the following three aspects:

**Running Mode**

**Control Mode:** System control and data processing are done by the computer, and the sampling and output are achieved by the DSP using serial communication.

**Monitor Mode:** System control is completed by DSP; the computer is just used for observation and preservation of data.

**Control Mode (User-Defined):** When the users design their control algorithms, experimental control is done in this mode; system control and data processing are done by the computer, and the sampling and output are achieved by the DSP using serial communication..

**Basic Setting**

It is used to set the hardware parameters, including motor full capacity voltage, dead voltage, which generally do not need to change. The other is adjusting zero of the pendulum and the spiral arm, when the accident collision has happened, you may need to adjust them. When the system is input values, the pendulum or the spiral arm will bring out corresponding shift.

c. Ka, Ko, Kva, Kvo are the feedback factors of state feedback control method.

When achieving the swing-up control, you can adjust swing-up voltage, braking angle and correct parameters according to the actual situation.

## MATHEMATICAL MODEL ANALYSIS

### Experimental Contents and Steps

- Building model using mechanism method

System building model and parameter measurement is the first step to design control algorithm; more precise mathematical model is the establishment of control system design. Here, the model is simply analyzed and equation of the inverted pendulum is derived with Newtonian mechanics: [2]

In figure 6, according to Newtonian mechanics, in non-inertial coordinate system S2, for the pendulum:

$$J_2 \ddot{\theta}_2 + f_2 \dot{\theta}_2 = M_{12} + m_2 g L_2 \sin \theta_2 \quad (1)$$

Where, M12 is torque happened by the spiral arm effect on the pendulum:

$$M_{12} = m_2 L_2 [R \dot{\theta}_1^2 \sin(\theta_1 - \theta_2) - R \ddot{\theta}_1 \cos(\theta_1 - \theta_2)] \quad (2)$$

In non-inertial coordinate system S2, for the spiral arm:

$$J_1 \ddot{\theta}_1 + f_1 \dot{\theta}_1 = M_0 + M_{21} + m_1 g L_1 \sin \theta_1 \quad (3)$$

Where, M0 is output torque of motor:

$$M_0 = K_m (u - K_e \dot{\theta}_1) \quad (4)$$

Where, M21 is is torque happened by the pendulum effect on the spiral arm, using reaction rule:

$$\begin{aligned} M_{21} &= m_2 \left[ g + \frac{d^2}{dt^2} (R \cos \theta_1 + L_2 \cos \theta_2) \right] \cdot R \sin \theta_1 - m_2 \left[ \frac{d^2}{dt^2} (R \sin \theta_1 + L_2 \sin \theta_2) \right] \cdot R \cos \theta_1 \\ &= m_2 g R \sin \theta_1 - m_2 R^2 \ddot{\theta}_1 - m_2 R L_2 \ddot{\theta}_2^2 \sin(\theta_1 - \theta_2) - m_2 R L_2 \ddot{\theta}_2 \cos(\theta_1 - \theta_2) \end{aligned} \quad (5)$$

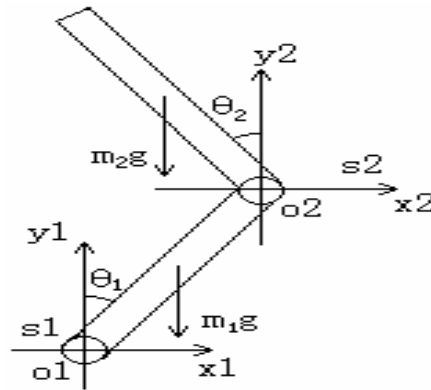


Figure 6: Model Analysis of XZ-II Rotary Inverted Pendulum System

Solving (1) ~ (5) and eliminating the intermediate variables M12 and M21 can get system nonlinear matrix model.

### System Nonlinear Matrix Model

$$\begin{aligned} & \begin{bmatrix} J_1 + m_2 R^2 & m_2 R L_2 \cos(\theta_1 - \theta_2) \\ m_2 R L_2 \cos(\theta_1 - \theta_2) & J_2 \end{bmatrix} \begin{bmatrix} \ddot{\theta}_1 \\ \ddot{\theta}_2 \end{bmatrix} + \begin{bmatrix} f_1 + K_m K_e & m_2 R L_2 \sin(\theta_1 - \theta_2) \dot{\theta}_2 \\ m_2 R L_2 \sin(\theta_2 - \theta_1) \dot{\theta}_1 & f_2 \end{bmatrix} \begin{bmatrix} \dot{\theta}_1 \\ \dot{\theta}_2 \end{bmatrix} \\ & = \begin{bmatrix} K_m \\ 0 \end{bmatrix} u + \begin{bmatrix} m_1 g L_1 \sin \theta_1 + m_2 g R \sin \theta_1 \\ m_2 g L_2 \sin \theta_2 \end{bmatrix} \end{aligned} \quad (6)$$

According to (6) and making  $\theta_1 \rightarrow 0$ ,  $\theta_2 \rightarrow 0$  can finish the linearization of nonlinear system.

### System Linear Matrix Model

$$\begin{bmatrix} J_1 + m_2 R_1^2 & m_2 R_1 L_2 \\ m_2 R_1 L_2 & J_2 \end{bmatrix} \begin{bmatrix} \ddot{\theta}_1 \\ \ddot{\theta}_2 \end{bmatrix} + \begin{bmatrix} f_1 + K_m K_e & 0 \\ 0 & f_2 \end{bmatrix} \begin{bmatrix} \dot{\theta}_1 \\ \dot{\theta}_2 \end{bmatrix} = \begin{bmatrix} (m_1 L_1 + m_2 R_1) g & 0 \\ 0 & m_2 g L_2 \end{bmatrix} \begin{bmatrix} \theta_1 \\ \theta_2 \end{bmatrix} + \begin{bmatrix} K_m \\ 0 \end{bmatrix} u \quad (7)$$

Making  $J = \begin{bmatrix} J_1 + m_2 R_1^2 & m_2 R_1 L_2 \\ m_2 R_1 L_2 & J_2 \end{bmatrix}$ ,  $F = \begin{bmatrix} f_1 + K_m K_e & 0 \\ 0 & f_2 \end{bmatrix}$ ,  $M = \begin{bmatrix} (m_1 L_1 + m_2 R_1) g & 0 \\ 0 & m_2 g L_2 \end{bmatrix}$ ,

$$K = \begin{bmatrix} K_m \\ 0 \end{bmatrix}.$$

Then:

$$\begin{bmatrix} \ddot{\theta}_1 \\ \ddot{\theta}_2 \end{bmatrix} = -J^{-1} F \begin{bmatrix} \dot{\theta}_1 \\ \dot{\theta}_2 \end{bmatrix} + J^{-1} M \begin{bmatrix} \theta_1 \\ \theta_2 \end{bmatrix} + J^{-1} K u \quad (8)$$

### System Status Equation

$$\begin{cases} \dot{x} = Ax + Bu \\ Y = Cx \end{cases} \quad x = [\theta_1 \quad \theta_2 \quad \dot{\theta}_1 \quad \dot{\theta}_2]^T, y = [\theta_1 \quad \theta_2]^T$$

$$A = \begin{bmatrix} 0_{2 \times 2} & I_{2 \times 2} \\ J^{-1} M & -J^{-1} F \end{bmatrix}, B = \begin{bmatrix} 0_{2 \times 1} \\ J^{-1} K \end{bmatrix}, C = [I_{2 \times 2} \quad 0_{2 \times 2}] \quad (9)$$

The main mechanical parameters and variables of system are shown in table: 1

**Table 1: Mechanical Parameters and Variables**

spiral arm mass m1	0.200 Kg	pendulum mass m2	0.052 Kg
spiral arm length R1 (R)	0.20m	pendulum length R2	0.25m
The distance from spiral arm quality heart to shaft axis L1	0.10 m	The distance from pendulum quality heart to shaft axis L2	0.12 m
Motor torque – voltage ratio Km	0.0236 N·m/V	motor back EMF - speed ratio Ke	0.2865 V·S
Friction torque coefficient of spiral arm rotation around the axis f1	0.01 N·m·S	Friction torque coefficient of pendulum rotation around the axis f2	0.001 N·m·S
moment of inertia of spiral arm rotating around the axis J1	0.004 Kg·m <sup>2</sup>	moment of inertia of pendulum rotating around the axis J2	0.001 Kg·m <sup>2</sup>

### System Analysis

The parameter values are put into the equation (9) and inputting the following functions in MATLAB, We can get the system controllability, observability, characteristic roots, and then we can observe that the system is controllability, observability, open-loop unstable.

rank (ctrb (A, B))

rank (obsv (A, C))

eig (A)

System is completely controllable and observable, and therefore feedback control law can be determined according to the state feedback to control the system closed-loop stability of Rotary Inverted Pendulum [4].

## Simulation of Nonlinear Model

### Simulation Steps

- To choose the desired pole P and run file to get the state feedback matrix K;
- To put state feedback matrix K into L module in the figure 7 and click save;
- To click double integrator3 and set the initial value of x1 ( $\theta_1$ ) of the initial value, and to click double integrator1 and set the initial value of x2 ( $\theta_2$ ) of the initial value, and then run and observe the response curve.
- To select multiple poles and repeat the above steps.

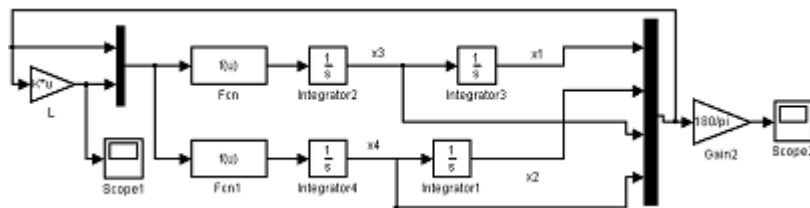


Figure 7: MATLAB Simulation of XZ-II Rotary Inverted Pendulum System

For convenience, making  $a=J_1+m_2R^2$ ,  $b=m_2RL_2$ ,  $c=J_2$ ,  $d=f_1+K_mK_e$ ,  $e=(m_1L_1+m_2R)g$ ,  $f=f_2$ ,  $h=m_2gL_2$  and don't thinking about input voltage, means  $u=0$ , then system nonlinear matrix model:

$$\begin{bmatrix} a & b \cos(\theta_2 - \theta_1) \\ b \cos(\theta_1 - \theta_2) & c \end{bmatrix} \begin{bmatrix} \ddot{\theta}_1 \\ \ddot{\theta}_2 \end{bmatrix} + \begin{bmatrix} d & b \sin(\theta_1 - \theta_2)\dot{\theta}_2 \\ b \sin(\theta_2 - \theta_1)\dot{\theta}_1 & e \end{bmatrix} \begin{bmatrix} \dot{\theta}_1 \\ \dot{\theta}_2 \end{bmatrix} + \begin{bmatrix} -f \sin \theta_1 \\ -h \sin \theta_2 \end{bmatrix} = 0 \quad (10)$$

In MATLAB, the value of each parameter is substituted into the nonlinear mathematical model to simulate, which means the ODE function is used for solving differential equations, simulation of several typical situations are:

- **The Establishment of Nonlinear Differential Equations of Rotational Inverted Pendulum Model**

Running MATLAB6.0 version

Function `xdot=dlfun(t,x);`

`m1=0.200; m2=0.052; L1=0.10; L2=0.12; r=0.20; km=0.0236; ke=0.2865;`

`g=9.8; J1=0.004; J2=0.001; f1=0.01; f2=0.001; % value of parameter`

`a=J1+m2*r*r; b=m2*r*L2; c=J2; d=f1+Km*Ke; e=(m1*L1+m2*r)*g; f=f2; h=m2*L2*g;`

`K=[ * * * *]; % State feedback gain matrix obtained according to the desired pole;`

`u=-K*[x(1);x(2);x(3);x(4)]; % control variable`

```

xdot=zeros(4,1);

xdot(1)=x(3);

xdot(2)=x(4);

xdot(3)=((-d*c).*x(3)+(f*b*cos(x(2)-x(1))).*x(4)+b*b*sin(x(2)-x(1)).*cos(x(2)-x(1)).*x(3).*x(3)-b*c*sin(x(1)-x(2)).*x(4).*x(4)+e*c*sin(x(1))-h*b*sin(x(2)).*cos(x(2)-x(1))+km*c*u)/(a*c-b*b.*cos(x(1)-x(2)).*cos(x(2)-x(1)));

xdot(4)=((d*b*cos(x(1)-x(2))).*x(3)-(a*f).*x(4)-a*b*sin(x(2)-x(1)).*x(3).*x(3)+b*b*sin(x(1)-x(2)).*cos(x(1)-x(2)).*x(4).*x(4)-e*b*sin(x(1)).*cos(x(1)-x(2))+a*h*sin(x(2))-b*cos(x(1)-x(2))*km*u)/(a*c-b*b.*cos(x(1)-x(2)).*cos(x(2)-x(1))); % differential equations to describe the nonlinear model;

```

- **To Solve Nonlinear Differential Equation Model**

```

clear;

t0=0;tf=20;

[-0.1;0.05;0;0];

KK=[4.7902 -57.7481 -3.7602 -6.6982];

u0=-KK*r;

x0=[-0.1;0.05;0;0;u0];

x0=[0.05;0.05;0;0];%

[t,x]=ode45('dlfun',[t0,tf],x0); % solve differential equations

figure;

plot(t,x(:,1),'r',t,x(:,2),'b'); % draw the response curve

title('output curve');

legend('spiral arm angle',' the pendulum angle);

Initial state values

```

- **Pole Assignment and to Obtain State Feedback Gain Matrix**

```

clear

A=[0 0 1 0;

0 0 0 1;

65.875 -16.875 -0.00010191 -1.248e-006;

-82.212 82.212 -2.0918e-005 -1e-006]; % System matrix

B=[0;0;5.2184;-6.5125]; % Control Matrix

C=[1,0,0,0;0,1,0,0]; % output matrix

P=[-4+3i,-4-3i,-8-6i,-8+6i]; % expect pole

```

$K = \text{place}(A, B, P)$ ; % state feedback gain matrix

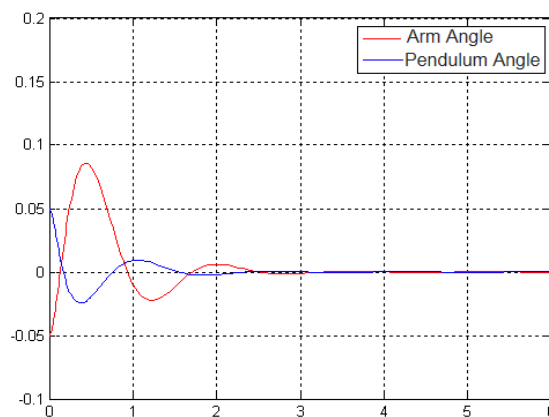
To get feedback matrix  $K$  using the pole assignment method: taking any a set of poles  $P$ , and using  $\text{place}(A, B, P)$  function in MATLAB can obtain  $K = [K_a, K_o, K_{va}, K_{vo}]$ .

### Simulation Steps

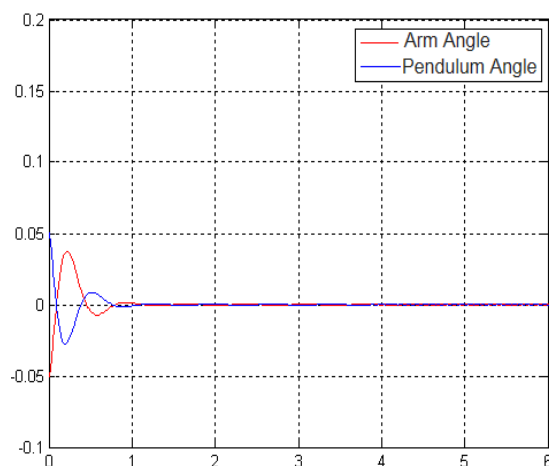
- To choose the desired poles  $P$
- To put the state feedback matrix  $K$  into
- To set the initial value of the system, run and observe the response curve.
- To select multiple poles and repeat the above steps.

### Real-Time Control

According to the actual operation of the inverted pendulum, these parameters can be modified to improve the control effect. When the inverted pendulum control has been done, need to test of its anti-interference properties. When a range of disturbance is given to the pendulum, inverted pendulum can quickly return to equilibrium, when the disturbance is too large, inverted pendulum may be out of control and fall.

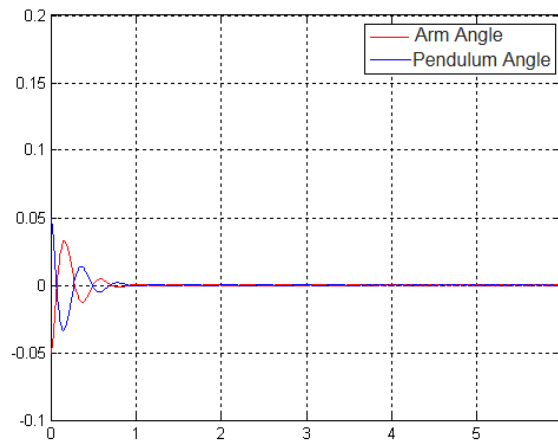


**Figure 8: Angle Curve Response-1 of XZ-II Rotary Inverted Pendulum System**

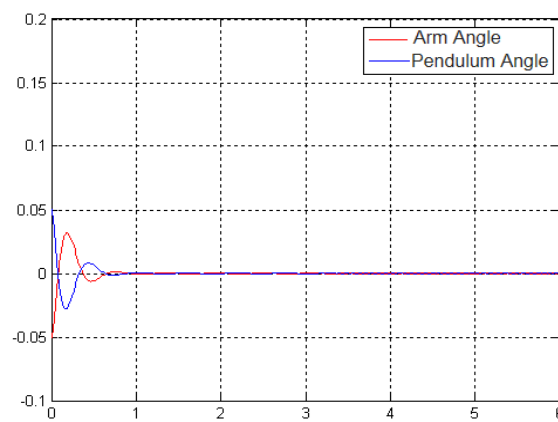


**Figure 9: Angle Curve Response-2 of XZ-II Rotary Inverted Pendulum System**





**Figure 10: Angle Curve Response-3 of XZ-II Rotary Inverted Pendulum System**



**Figure 11: Angle Curve Response-4 of XZ-II Rotary Inverted Pendulum System**

**Figure 8~11:** The change of Degree1 (Arm Angle) and Degree2 (Pendulum Angle). We tested four groups of pole points. They are as follows.

**Figure 8:**  $[-4+3i, -4-3i, -8+6i, -8-6i]$

**Figure 9:**  $[-16+3i, -16-3i, -8+6i, -8-6i]$

**Figure 10:**  $[-16+12i, -16-12i, -13+10i, -13-10i]$

**Figure 11:**  $[-16+3i, -16-3i, -13+6i, -13-6i]$

## CONCLUSIONS

In conclusion, we analyze the first-order rotational inverted pendulum system dynamics, and give derivation of the mathematical model and finish MATLAB simulation program and record the output data, curve, and the theoretical analysis. In the design of state feedback parameters, the multiple poles should be given, to observe the simulation results and to compare overshoot, adjusting time and other performance indicators. It shows nonlinear systems to be local linearization and describe the relationship between pole positions and the dynamic performance, steady-state performance, and stability. The simulation results show that method can get the XZ-II rotary inverted pendulum pendulum stabilized [3].

## ACKNOWLEDGEMENTS

The authors would like to acknowledgement technical support from HEU teaching experimental libortary and financial support from the Hohai University, Nanjing China.

**REFERENCES**

1. Huang Mei, Zhang He “Study on stability control for single link rotary inverted pendulum” *International Conference on Mechanic Automation and Control Engineering (MACE) IEEE*, PP. 6127-61-30, June 26-28, 2010
2. Yunhai Hou, Hongwei Zhang, Kai Mei “Vertical-rotary inverted pendulum system based on fuzzy control” *International Conference on Electrical and Control Engineering (ICECE), IEEE*, pp. 2804-2807, sept 16-18, 2011
3. Zhang Juan, Chen Jie, Li Peng “Obstacle Rotary Inverted Pendulum Control via Polytope Techniques” *International Conference on Mechtronic and Embedded Systems and Applications (MESA), IEEE/ASME*, pp. 597-601, Oct 12-15, 2008
4. Anvar, S.M.M.,Hassanzadeh, I., Alizadeh, G. “Design and implementation of sliding mode-state feedback control for stabilization of Rotary Inverted Pendulum” *International Conference on Control Automation and Systems (ICCAS) IEEE*, pp. 1952-1957, Oct. 27-30, 2010
5. Ahangar-Asr, H., Teshnehlab, M., Mansouri, M. ; Pazoki, A.R. “A hybrid strategy for the control of Rotary Inverted Pendulum” *International Conference on Electrical and Control Engineering (ICECE) IEEE*, pp. 5656 – 5659, Sept. 16-18, 2011