

## AUTOMATIC SYSTEM AND METHOD FOR IMPROVING AERIAL SPRAY DROPLET PENETRATION

### 提高航空喷雾雾滴穿透性的方法和自动系统研究

Zhiwei TIAN <sup>1,2)</sup>, Xinyu XUE <sup>3)</sup>, Famin DUAN <sup>1)</sup>, Sen YAO <sup>1,2)</sup>, Wei MA <sup>\*1)</sup>

<sup>1)</sup> Institute of Urban Agriculture, Chinese Academy of Agricultural Sciences, Chengdu / China;

<sup>2)</sup> Chengdu National Agricultural Science and Technology Center, Chengdu / China;

<sup>3)</sup> Nanjing Research Institute for Agricultural Mechanization, Ministry of Agriculture and Rural Affairs, Nanjing / China

Tel: 8613521210452; E-mail: mawei03@caas.cn

DOI: <https://doi.org/10.35633/inmateh-68-26>

**Keywords:** aerial application, unmanned aerial vehicle (UAV), droplet penetration, spray system optimization

#### ABSTRACT

When UAVs apply a pesticide at different speeds, droplet deposition area and canopy vortex area are not at the same location, which prevents droplets from depositing on the backside of leaves and lower part of plants in canopy vortex, and affects spray quality and pests and diseases control effect. To shorten the distance between the two areas and improve droplet penetration, a method for adjusting nozzle inclination angle based on droplet force analysis and tests was proposed in this paper. According to the obtained model, an automatic nozzle angle adjustment system was developed from hardware and software. The experimental results showed that the number of droplets deposited on the entire leaf increased by 21.58% when UAV spraying with the system mounted. The average number of droplets on the front side of the leaf increased by 14.44% while 66.05% was on the backside of the leaf with the system mounted. This indicates that the method and system proposed have a significant impact on improving the UAV spray penetration.

#### 摘要

无人机以不同速度施药时，液滴沉积区和冠层涡流区不在同一位置，导致液滴无法沉积在叶片背面和植物下层，影响喷雾质量和病虫害控制效果。为了弥补两区域之间的间距并提高液滴渗透率。本文基于液滴受力分析和试验，提出了一种调整喷嘴倾角的方法。发现最佳喷管角度( $y$ )与无人机飞行速度( $x$ )的关系为： $y = -0.367x^2 + 6.2932x - 0.8438$ ， $R^2 = 0.8333$ 。根据该模型，从硬件和软件上开发了自动喷嘴角度调整系统。结果表明，安装该系统的无人机喷洒后，沉积在整个叶片上的液滴数量增加了 21.58%，叶片正面平均液滴数增加了 14.44%，而叶片背面的液滴数量增加了 66.05%。这表明所提出的方法和系统对提高无人机喷雾穿透能力有着显著影响。

#### INTRODUCTION

In the past decade, small rotor UAVs have been widely used in pesticide application, covering staple food crops, oil crops and cash crops (Xue *et al.*, 2020). During the pesticide application, rotors often provide lift force for the UAV body while generating strong downwash airflow (Fan *et al.*, 2019). When the airflow spreads to the crop canopy, it would swing plants seriously and form a canopy vortex. As shown in Figure 1, the plants in the vortex sway, and their leaves turn over, which is a specific spray characteristic of a small plant protection UAV (Wei *et al.*, 2021).

Theoretically, the canopy vortex is helpful to promote droplet penetration by blowing crop canopy dispersing, and increasing the number of droplets deposited on the backside of leaves and the lower part of plants, and give a positive effect on pests and diseases control, because some crop pests and diseases, such as powdery mildew, rice planthoppers, and cotton aphids, are mainly parasitic on the lower parts of plants and the back of leaves. The more droplets deposited on these target areas, the more chance the diseases and pests are exposed to pesticides. It is indispensable to ensure a perfect control effect (Qin *et al.*, 2018). On the other hand, more droplets falling on the target area means fewer droplets are lost, the effective spray is important for avoiding excessive application of pesticides and protecting the environment.

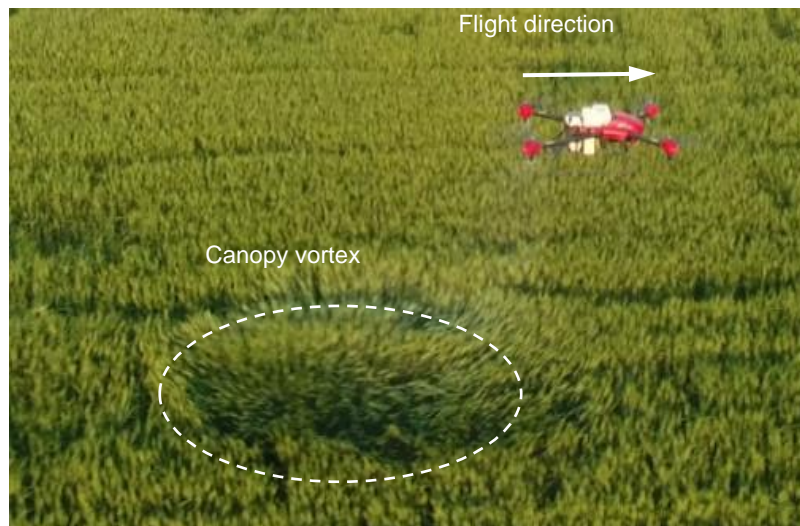

**Fig. 1 - Crop canopy vortex caused by rotor downwash airflow**

For these reasons, understanding the canopy vortex features and making full use of them is a potential research topic. To some extent, it decides UAV spray quality. Some researchers have investigated the distribution characteristics of the canopy vortex and its influence on droplet deposition. Based on field tests, *Li Jiyu et al., (2018)*, found that the obvious canopy vortex of multi-rotor UAVs has a significant promotion on the droplet distribution. The number of droplets deposited under flight with a large-size canopy vortex was 1.5 times more than those with a small-size vortex and 7 times more than the flight without a canopy vortex (*Guo et al., 2019*). So, it is believed that the canopy vortex should be taken seriously, and this area is regarded as the target area where the droplets should be sprayed (*Lan et al., 2018*). However, the canopy vortex is not always effective in improving the deposition performance of droplets. We carried out many spray experiments under different UAV operating parameters in 2018 and 2019 (*Tian et al., 2020a*). The results showed that the positive effect of canopy vortex on droplet penetration is not constant, and it varied with operating parameters greatly. To figure out the reasons, our team extracted the canopy vortex area at different UAV flight speeds based on machine vision technology and compared their distribution characteristics in 2020 (*Tian et al., 2020b*). According to the research results and spray process observation, it was concluded that the downwash airflow can only improve the droplet penetration effectively when three conditions are met: (i) the droplets can travel to the crop canopy, (ii) the airflow is strong enough to sway the crop canopy and make leaves turn over, and (iii) the final deposition area of droplets have to be at the same location with the canopy vortex area, so droplets can fall on the leaves back and the lower part of plants in time when crop canopy sway.

The small plant protection UAV often flies at a low-altitude manner of less than 5 m, so it is easy to form a canopy vortex as airflow is still strong even coming to crop canopy. On the other hand, nozzles of many UAVs are amounted below the rotors. The downward airflow from rotors would transport droplets to the crop canopy. Therefore, the conditions of (i) and (ii) are easy to be met, while (iii) mentioned above is difficult in the practical spray. When UAV is hovering, the droplet deposition and canopy vortex areas are both located directly below the UAV body and overlap with each other (*Yang et al., 2018*). When it moves quickly, during the time droplets and airflow travel down to the crop canopy, UAV has moved forwards a distance, which makes the two areas look like they have a lag relative to the location of the drone (*Yang et al., 2018*). Due to particle weight differences, the velocity attenuation rate of airflow and droplets are different when they move in the air (*Chen et al., 2017*). There is a much velocity loss for airflow but less for droplets. At the same falling height, airflow takes more time. So, there is a distance gap between the droplet deposition area and canopy vortex area when they reach crop canopy. The droplet deposition area is ahead of the canopy vortex area, which weakens the positive effect of canopy vortex on droplet penetration.

In this paper, a method by adjusting nozzle spray angle was proposed based on droplet force analysis to eliminate the gap between the droplet deposition and the canopy vortex areas. Then, the relationship between optimal nozzle angles and different flying speeds was studied through experiments. And based on the results, an automatic system was developed for nozzle angle adjustment. Finally, the spray performance of the UAV equipped with the system was tested.

**MATERIAL AND METHODS**

**METHOD ANALYSIS OF ADJUSTING NOZZLE SPRAY ANGLE**

**Force analysis of droplet under different nozzle angle**

UAV flight speed is the main reason causing a lag of the canopy vortex and droplet deposition areas (Tian et al., 2020c). There are different lag distances between the two areas at different speeds, while the flight height has a little contribution to it. In practical pesticide application, the UAV flight height is usually constant around 2 m, while the flight speed setting varies within the range of 1~8 m/s in the existing researches (QIN et al., 2017). As a result, our focus is on how to improve the positional relationship between the canopy vortex and the droplet deposition area at different UAV flying speeds. As analyzed in the INTRODUCTION, the canopy vortex is behind the droplet deposition area. As shown in Figure 2, it is necessary to move the canopy vortex forward or move the droplet deposition area backward to make the two areas at identical location. The canopy vortex is determined by the rotor wind field and is related to the UAV body structure and flight principle, which was difficult to be changed. Therefore, optimizing the spray system and making the droplet deposition area move backward to minimize the distance  $a$  is a valuable method.

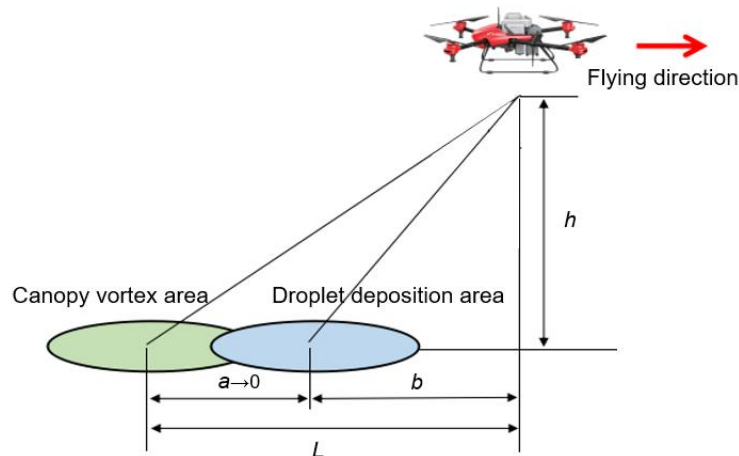

**Fig. 2 - Distribution of canopy vortex and droplet deposition area**

P20 (Guangzhou Jifei Technology Co., Ltd.), the commonly used electric four-rotor plant protection UAV in China, was a subject in this research. The effective spray width of P20 is 3 m, four centrifugal nozzles are assembled under each rotor, and the spray volume can be set from 0 to 15 L·ha<sup>-1</sup> with a load capacity of 10 kg. Flying speed can be configured from 1 to 12 m·s<sup>-1</sup>. The RTK provides high-precision positioning and navigation with an accuracy of a centimeter.

Centrifugal nozzle has a better atomization effect compared with traditional nozzles. The liquid is atomized by a centrifugal disc with high rotation speed and sprinkled under the centrifugal force. Droplet movement is mainly affected by  $G$  (Gravity),  $F_a$  (Centrifugal force),  $F_w$  (Pressure force of downwash airflow), and  $F_f$  (Air resistance). As shown in Figure 3(a), when the nozzle is installed downwards as normal,  $G$  and  $F_w$  are downward, and  $F_a$  is distributed tangentially along the edge of the disc. The direction of  $F_f$  is opposite to the droplet movement. In Figure 3(b) when the nozzle tilts backward, the force of  $G$ ,  $F_w$ , and  $F_f$  on the droplet is consistent with the vertical condition, but the direction of centrifugal force  $F_a$  changes.

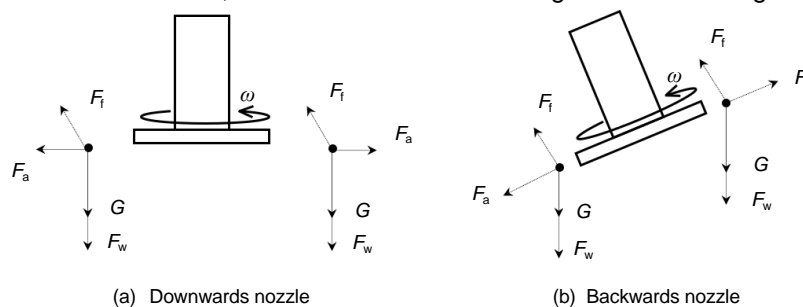

**Fig. 3 - Force analysis on droplet under different nozzle angles**

The centrifugal force on the droplet in front of the nozzle tilts downwards. Its vertical downward component can further promote the droplet falling. The centrifugal force on the droplet behind the nozzle tilts upwards.

Its horizontal backward and vertical upward components can help the droplet move more distant backward, as these force components increase the droplet falling time. Therefore, a proper backward nozzle inclination angle would make part of droplets move backward, making up the distance between the canopy vortex and the droplet deposition areas. At the same time, it would help to promote some droplets depositing downward.

### Statistical analysis on nozzle angle and flight speed

Different flight speeds should match the corresponding nozzle inclination, which is determined by droplet distribution characteristics. In many researches, CFD (Computational Fluid Dynamics) was used to simulate downwash airflow distribution and droplet deposition. However, it is difficult to make sure the simulation results are close to practical conditions because of model choices and parameters setting (Parra H.G. et al., 2019). In this paper, field tests were conducted to investigate the optimal nozzle angle of each UAV flight speeds.

A framework was designed and installed at the rotor arm to achieve nozzle angle adjustment. Before the UAV taking off different nozzle angles were set manually, and when the spraying tests were finished, the optimal nozzle angle was evaluated through droplet deposition information on the backside of plant leaves. Taking usual operating parameters as a reference, the flight height is constant at 2 m while the operating speeds are 3, 4, 5, and 6 m/s, respectively. When the nozzle angle of P20 is greater than 45°, part of the droplets would be lifted to air and cause droplet loss. On the other hand, the pre-experiments showed that small angle divisions have no obvious distinction in droplet deposition. Based on these factors the nozzle angle was set to 0°, 10°, 20°, 30°, and 40° under each speed. There are 20 group tests in total and each test has 3 repetitions.

Experiments were carried out at 10 a.m. on December 4th, 2019, at the test field of Nanjing Institute of Agricultural Mechanization, Ministry of Agriculture and Rural Affairs. During the test, meteorological data was recorded by a Kestrel 4500 Environmental Meter (Nielsen-Kellerman, USA). The air temperature was 22.4~25.6°C, the relative humidity was 41.3%~ 55.3%, and the wind speed was within 1.9 m·s<sup>-1</sup>. The spray liquid is an Allure Red aqueous solution with a ratio of 5%. As shown in Figure 4a, on a flat ground 10 sampling rods were arranged in two rows, the vertical and horizontal distance between them was 60 cm. Paper cards were fixed on the sampling rods 40 cm away from the ground. The front side of the paper card represents the front side of the plant leaf, while the backside was the back of a leaf. UAV's flying route was consistent with the long axis of the sampling rod, and it was located in the middle of rows. The route length was 50 m. To avoid the influence of unstable airflow during the acceleration and deceleration phase of the drone, sampling rods were put in the middle of the flying route. For each flight, the spray liquid was added to 8 L to maintain the UAV attitude constant. The spray volume was set to 12 L·hm<sup>-2</sup> while the droplet size was 120 µm. After each flight was completed, paper cards were collected into ziplock bags for storage. They were taken to Lab and scanned into images with a resolution of at least 600 dpi. Finally, images were analyzed through ImageJ (National Institutes of Health, USA) to obtain droplet deposition information, including droplet number per unit area and droplet size (Shown in Figure 4c).

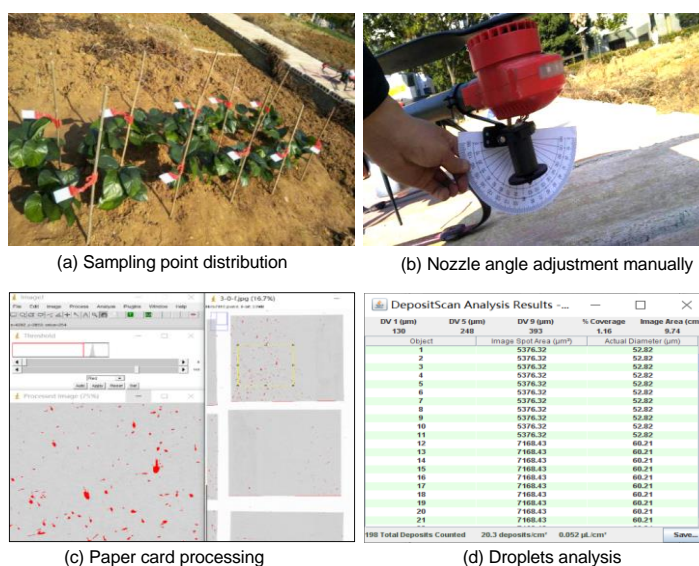

Fig. 4 - Test site and droplets analysis



The number of droplets deposited on the backside of the leaf at 10 sampling points was averaged to get the droplet deposition levels of this test. One-way ANOVA was used to analyze the influence of different spray angles on the number of droplets deposited on the back of the leaves. The results are shown in Table 1, P-value=2.52E-05<0.01, and F=28.154>Fcrit=4.301, indicating that in the case of α=0.05, there is a significant difference in the number of droplets deposited under different spray angles.

Table 1

Variance analysis						
Source of difference	SS	df	MS	F	P-value	F crit
Between groups	1768.167	1	1768.167	28.15416	2.52E-05	4.30095
Within-group	1381.667	22	62.80303			
Total	3149.833	23				

For each flight speed, the optimal nozzle angle was screened out based on the droplet number of leaf back. When the drone is hovering, the nozzle is vertically downward and has no adjustment, so the beginning point of the line was connected with the origin coordinate to estimate the nozzle angle curves when UAV speed is less than 3 m/s, and to meet the angle adjustment requirements of UAV acceleration period, as shown in figure 5. Finally, a regression analysis based on the quadratic polynomial was adopted to describe the relationship between UAV flight speed (x / m·s<sup>-1</sup>) and optimal nozzle angle (y / °).

The model is expressed as:

$$y = -0.367x^2 + 6.2932x - 0.8438, R^2 = 0.8333 \tag{1}$$

R<sup>2</sup> is the correlation coefficient, the closer the value of R<sup>2</sup> is to 1, the better the fitting effect of the model and the stronger the linear correlation between the two variables.

The fitting line shows that the optimal nozzle angle increases first and then sees a decreasing trend with UAV flight speed increase. When the drone sprays at different flying speeds, the spray effect of adjusting the nozzle angle are better than that without adjusting the nozzle inclination (nozzle angle is 0 degrees)

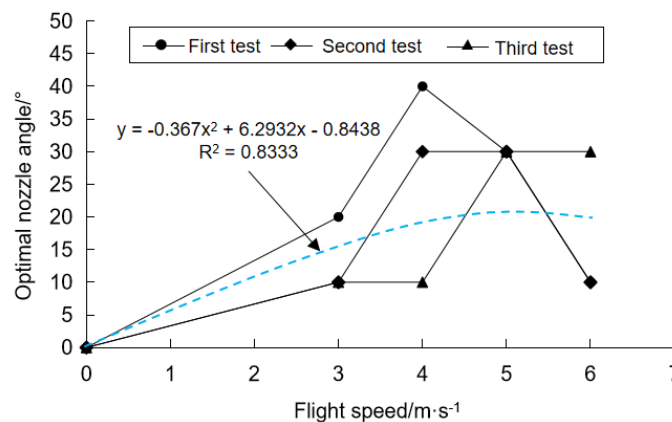

Fig. 5 - Relationship between flight speed and optimal nozzle angle

## DEVELOPMENT OF AUTOMATIC NOZZLE ANGLE ADJUSTMENT PLATFORM

### Hardware of control system

To achieve automatic adjustment of nozzle angle in real-time a system was designed. The optimal nozzle inclination varies with different operating speeds of UAV, so in this system, the flying speed needs to be collected firstly. And then the best nozzle angle is calculated according to the model in figure 5. Finally, the nozzle was driven to the expected position through the servo motor.

Arduino Uno was used as a controller, because this module is small in size, light in weight, low in cost, and it has been used widely in agricultural intelligent control scenarios. The working voltage is 5V and powered by two rechargeable lithium-ion batteries. The NEO-6M GPS module collects UAV flight speed in real-time. The size of the module is 31.5×25.5×8.2 mm, the collecting accuracy of speed is 0.01m·s<sup>-1</sup>. The servo motor of RB-65PG was used to change the nozzle angle, with the control accuracy of 0.24°, and the maximum torque can reach 0.8 N·m. E103-W02 WiFi module can perform remote communication. This module's effective communication distance is 350 m.

Crop fields are broken down into small pieces in many provinces of China except Xinjiang and Neimeng. These small fields have different crops and owners, which limits UAV flying distance and more than 80% of UAV single flying route is within 200 m. Therefore, the communication distance of WiFi module is enough to cover UAV flying range. An LCD screen was also installed to help debug and read system parameters.

At the beginning, the controller reads UAV speed through the GPS module and calculates the optimal nozzle angle according to the model. Then the signal is sent to the servo motor through PWM and the servo motor drives the nozzle to the expected angle. At the same time, the current UAV flight speed and nozzle angle are displayed on an LCD screen. This data is also sent to the cloud for monitoring. The controller compares the deviation between the current nozzle angle and the optimal one continuously and changes the nozzle angle in real-time. As shown in Figure 6, all modules are integrated into the control box. IDE was used as platform to code and run the C program.

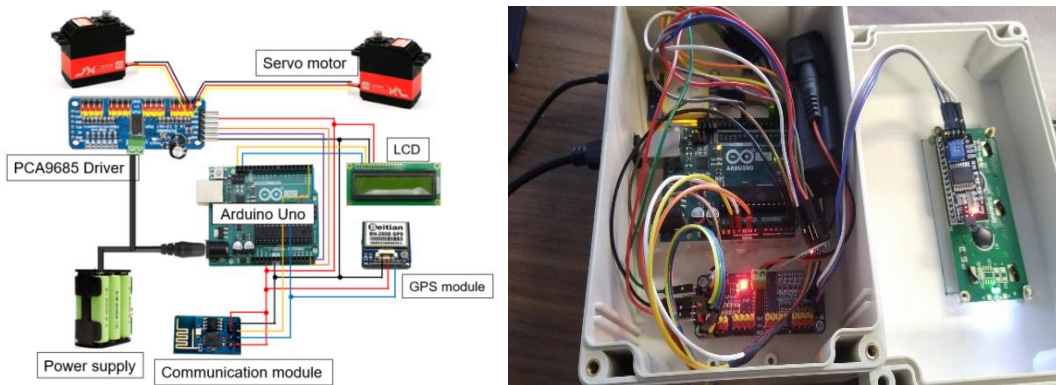

Fig. 6 - Hardware structure of nozzle angle adjustment system

However, the continuous adjustment will make the system too sensitive and frequent-shaking to spray stably. As a result, the model in figure 5 was dispersed and shown in Table 2. The error between the expected nozzle angle and the current one is changing with time.

Table 2

Nozzle angle controlling method	
Speed scope ( $x / m \cdot s^{-1}$ )	Nozzle angle ( $y / ^\circ$ )
$0 \leq x < 1.5$	5
$1.5 \leq x < 2.5$	10
$2.5 \leq x < 3.5$	15
$3.5 \leq x < 4.5$	18
$4.5 \leq x < 5.5$	21
$5.5 \leq x < 6.5$	24
$6.5 \leq x < 7.5$	25
$x \geq 7.5$	26

**Spray data monitoring platform**

Monitoring the system parameters is helpful to detect its working status and prevent some failures ahead of time. An Android APP was developed based on App Inventor, an Android programming framework launched by Google. App Inventor not only has the advantages of easy development and high efficiency but also has a network database allowing clients access to data at any time.

The APP has two performances, one is reading and displaying current UAV speed and nozzle angle from the cloud. APP sends a GET request to cloud server through URL and API reading code, then receives JSON text. The text is parsed to the current system data. The second one is sending data to the cloud. This part could control the nozzle angle remotely. When the UAV speed is constant the nozzle angle can be set manually instead of frequent adjustment automatically. Clicking the mode button to choose manual mode, and entering a number within 0-45 can configure a nozzle angle. This data would be sent to the cloud and request writing through the URL and API writing code, waiting for the nozzle angle control system to read and execute.

The APP interface for system monitoring is shown in Figure 7. In this project, ThingSpeak was adopted as a cloud to connect the nozzle angle adjustment system and the client's APP. It can collect and stores sensor data through APP and API codes, additionally, ThingSpeak also supports data export access.

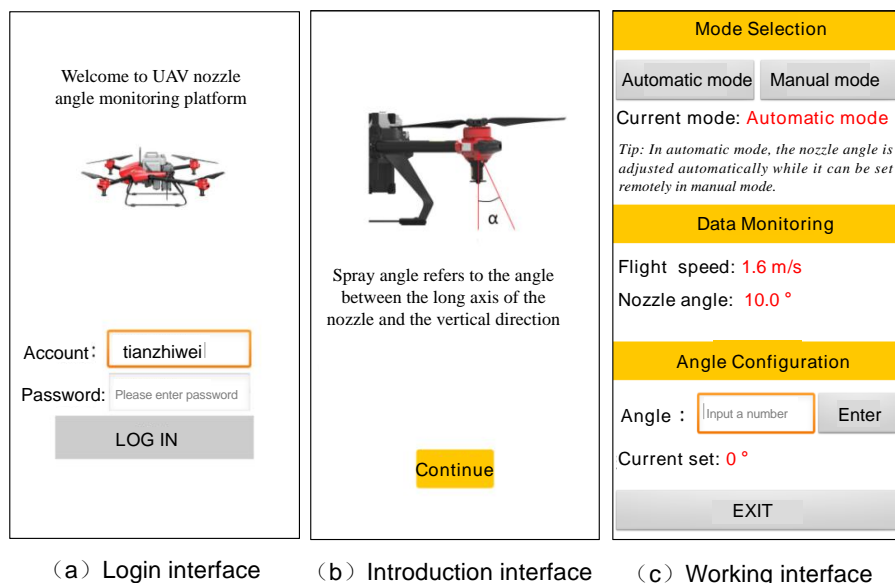

Fig. 7 - APP of nozzle angle adjustment system

### DROPLET PENETRATION TESTS BASED ON THE ANGLE ADJUSTMENT SYSTEM

In order to learn about how does the nozzle adjustment system affects spray quality and verify whether the system has a positive effect on droplet penetration, it was needed to collect and analyze the number of droplets deposited on the front and backside of leaves.

Experiments were carried out at 2:00 pm on November 16th, 2020, in the rape field of the Hetian Agricultural Machinery Service Cooperative in Gaochun District, Nanjing. The test field was 300 m×80 m in size. At that time, the plants were in the seedling stage with an average height of 10 cm, their leaves were too small to attach sampling paper cards. Therefore, the test method was as same as that carried out before, including sampling points distribution, the way UAV spray, and droplet deposition data analysis.



Fig. 8 - Experimental scene

### RESULTS

As shown in Figure 9a, regardless of whether the nozzle inclination adjustment system is installed or not, the number of droplets deposited on the front side of leaves decreased gradually with UAV flight speed increase. When the drone moved forward quickly, downwash airflow was weakened severely, the optimal meeting-point position of the downwash airflow from 4 rotors would lift. In this case, it not only doesn't promote droplet deposition but also has a "rolling-up effect", which rolls droplets up to the air. On the other hand, when the drone is flying at high speeds, the wind field is weak and sweeps across the plant canopy slightly, it can't overturn leaves and has a limited promotion effect on droplet penetration. When the system was installed, the number of droplets increased significantly. The faster the drone moves forwards, the more obvious the increase in the number of droplets.

As for the backside of the leaf, the droplet number of flight with the system was more than that without system installed for each speed. As shown in figure 9b, as flight speed increases, the number of droplets sees a dropping trend, which is the same as the condition of the front side of the leaf. When the drone flies slowly, the canopy vortex area is concentrated and in an elliptical shape, the plants in vortex sway seriously. When it flies fast the canopy vortex area is distributed in long strips, and plants sway slightly. From figure 9b it could be observed that the droplet number on the leaves' back is much more than others when UAV flying at 3 m/s, which indicates the concentrated canopy vortex is important for increasing droplet deposition on the backside of leaf. After the nozzle angle adjustment system was installed, the droplet number of 3 m/s increased more, because the strong downwash airflow under slow flight speed can sway plants and overturn leaves. At the same time, the backward nozzle helps droplets fall on this area in time, unlike the previous condition when droplet often falls on other areas. The results also imply flying speed of UAVs should not be too fast during pesticide application.

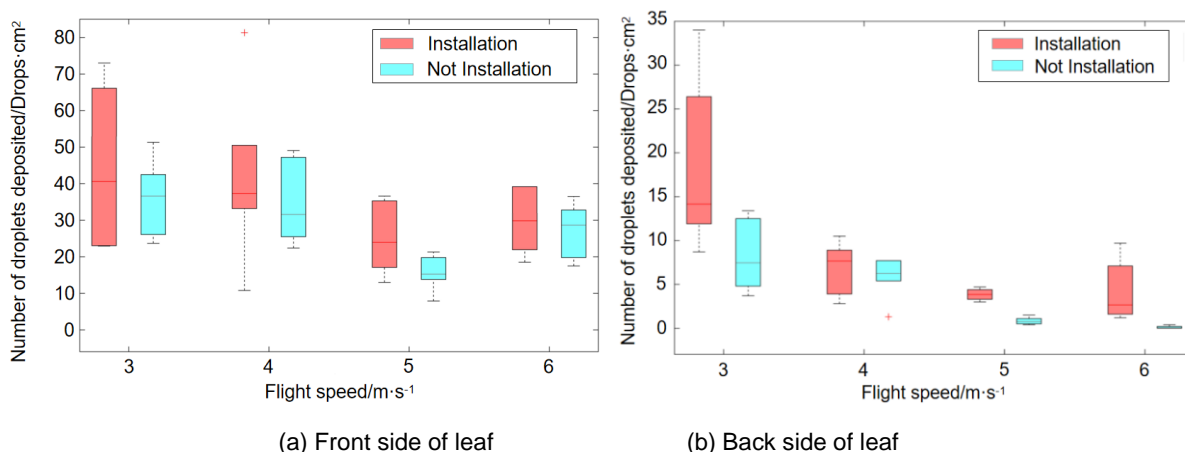

Fig. 9 - Comparison of number of droplets deposited with and without the system installed

The number of droplets deposited on the front and backside of leaves was summed to have the total droplet number on one leaf. As shown in Table 3, the droplet number on the entire leaf increased by 21.58% after the nozzle angle adjustment system was installed.

Table 3

Comparison of number of droplets deposited before and after system installation

Flying speed /m·s <sup>-1</sup>	Droplets deposited on the front side of leaf/Drops·cm <sup>-2</sup>		Droplets deposited on the backside of leaf/Drops·cm <sup>-2</sup>		Number of droplets deposited on whole leaf/Drops·cm <sup>-2</sup>	
	Without system	With system	Without system	With system	Without system	With system
3	36.13	38.38	8.22	18.22	44.35	56.6
4	34.57	41.73	6.90	7.31	41.47	49.04
5	20.55	24.98	2.83	3.85	23.38	28.83
6	27.32	30.6	1.08	2.22	28.40	32.82
<b>Average</b>	29.64	33.92	4.76	7.90	34.40	41.82

Droplet number increased by 27.62%, 18.25%, 23.31%, and 15.56% respectively at flight speeds of 3, 4, 5, and 6 m·s<sup>-1</sup>. Droplets number for the front side of the leaf was 29.64/cm² on average when UAV was spraying without the system, and 33.92/cm² when the system was installed, which increased by 14.44%. Without the system, the number of droplets deposited on the leaf back was 4.76/cm² on average, while 7.90/cm² with the system, this data increased by 66.05%. These results showed that the spray performance of UAVs with a nozzle angle adjustment system improved greatly, and the method and system proposed in this paper can improve the droplet penetration effectively.



## CONCLUSIONS

When plant protection UAV applies pesticide at different speeds, droplet deposition and canopy vortex areas are not at the same location, which prevents droplets from depositing on the backside of the leaf and lower layer of the plant, and affects spray quality and pests and diseases control effect. In order to bridge the gap between the two areas and improve droplet penetration, in this paper, the method of adjusting the nozzle inclination angle was analyzed and tested firstly. It was found that the relationship between UAV flight speed(x) and optimal nozzle angle(y) was expressed as:  $y = -0.367x^2 + 6.2932x - 0.8438$ ,  $R^2 = 0.8333$ . Based on this model an automatic nozzle angle adjustment system was developed from hardware and software. The results showed that the number of droplets deposited on the entire leaf increased by 21.58% when the UAV spraying with the system was installed. The average number of droplets on the front side of the leaf increased by 14.44% while 66.05% was on the backside of the leaf after the system was installed. These results proved the nozzle angle adjustment system has a positive effect for improving droplet penetration, and the spray performance of UAVs with nozzle angle adjustment system also improved greatly.

During the UAV spray process, the flight height is usually rarely changed. However, to improve the operation efficiency, the flight speed setting varies greatly, it has been reported in the range of 1–8 m·s<sup>-1</sup>. Based on this fact the system developed in our project only considered the impact of UAV flight speed on the distance between crop canopy vortex area and droplet deposition area. However, flight height has a slight influence on the distance between the two areas, because changes in height would change the time that airflow and droplet flow need to spread to the crop canopy. Although flight speed is the primary factor; it would be more indicated if factors like flight height is also considered before designing a nozzle angle adjustment system.

On the other hand, the droplet deposition area and the canopy vortex area are easily affected by crosswinds, they may be located obliquely behind the UAV. Some research reported that when the crosswind speed was 1.1-7.0 m/s, the cumulative drift rate of droplets was between 13.0% and 56.2%, so the industry standard stipulated plant protection UAV can only apply pesticide when crosswind speed less than 3 m/s (*T/CCPIA 019-2019*). Following the standard, the aerial spray should be stopped when the wind speed is too fast to prevent the droplets from drifting into the air. If this rule is followed well by growers, the system will not face the challenge mentioned above.

## ACKNOWLEDGEMENT

The authors thank the experts for editing our paper. We gratefully acknowledge the Local Finance Special Fund of Chengdu Agricultural Science and Technology Center (NASC2020KR05), Science and Technology Innovation Project Fund of Chinese Academy of Agricultural Sciences (ASTIP-2020-003), and the Science and Technology Innovation Project Fund of Chinese Academy of Agricultural Sciences (ASTIP-2020-001). We also thank the anonymous reviewers for their critical comments and suggestions to improve the manuscript.

## REFERENCES

- [1] Chen S.D., Lan Y.B., Bradley K.F., Li J.Y., Liu A.M., Mao Y.D. (2017). Effect of wind field below rotor on distribution of aerial spraying droplet deposition by using multi-rotor UAV. *Transactions of the Chinese Society for Agricultural Machinery*. 48(8): 105-113.
- [2] Fan Jiarong, Zhaohui, Feng Ya'nan et al. (2019). Effects of Rotor Wheelbase on Downwash Flow Aggregation and Wind-resistance. *Mechanical Science and Technology for Aerospace Engineering* 38(12):1966-1974.
- [3] Guo S., Li J. Y., Yao W. X., Zhan Y. L., Li Y. F. & Shi Y. Y. (2019). Distribution characteristics on droplet deposition of wind field vortex formed by multi-rotor UAV. *PLoS ONE*, 14(7), 22-34.
- [4] Lan Y. B., Wang L. L. & Zhang Y. L. (2018). Application and prospect on obstacle avoidance technology for agricultural UAV. *Transactions of the CSAE*, 34(9), 104-113.
- [5] Li J. Y., Lan Y. B. & Shi Y. Y. (2018). Research progress on airflow characteristics and field pesticide application system of rotary-wing UAV. *Transactions of the CSAE*, 34(12): 104-118.
- [6] Parra H.G., Morales V.D.A. & Garcia E.E.G. (2019). Multiphase CFD simulation of photogrammetry 3D model for UAV crop spraying. *World Conference on Information Systems and Technologies*, 4, pp. 812-822. Springer, Cham.
- [7] Qin W. C., Xue X. Y., Zhang S. M., Gu W. & Wang B. K. (2018). Droplet deposition and efficiency of fungicides sprayed with small UAV against wheat powdery mildew. *Int J Agric & Biol Eng*, 11(2): 27-32.

- [8] Qin Weicai. (2017). *Research on spraying parameters optimization for single-rotor plant protection UAV*. Zhenjiang: Jiangsu University.
- [9] T/CCPIA 019-2019, *Specification for Safe Application of Pesticide by Crop Protection UAS*.
- [10] Tian Z. W., Xue X. Y., Cui L. F., Chen C., Peng B., & Liu B. (2020). Comparison of droplet deposition characteristics and cotton aphid control effect of plant protection UAV working during the day and night. *Transactions of the CSAE*, 36(5), 69-77.
- [11] Tian Z.W., Xue X.Y., Xu Y., Yang F.B. & Sun Z. (2021). Effect of Plant Protection UAVs Downwash on Crop Canopy. *Transactions of the Chinese Society for Agricultural Machinery*, 52(1):40-48.
- [12] Tian Zhiwei. (2020). *Optimization Design of Operating Parameters and Spraying System of Multi-rotor Plant Protection UAV Against Cotton Aphid*, Beijing, Chinese Academy of Agricultural Sciences.
- [13] Wei X., Li J., Long B., Hu X., Wu H. & Li H.. (2021). Method for vortex shape retrieval and area calculation based on convex hull algorithm. *IEEE Access*, 9, 2706-2714.
- [14] Xue X. Y., Gu W., Xu Y., Sun Z. & Lan Y. B. (2020). Review on current state of agricultural UAS regulations and standards. *Transactions of the Chinese Society for Agricultural Machinery*, 51(10), 1-10.
- [15] Yang F.B., Xue Xi.Y., Cai C. & Zhou Q. Q. (2018). Effect of down wash airflow in hover on droplet motion law for multi-rotor unmanned plant protection machine. *Transactions of the CSAE*, 34(2), 64-73.
- [16] Yang Z. L., Ge L. Z., Qi L. J., Cheng Y. F. & Wu Y. L. (2018). Influence of UAV rotor downwash airflow on spray width. *Transactions of the Chinese Society for Agricultural Machinery*, 49(1), 116-122.