



Power Grid Frequency Control Improvement Using Pumped Storage Based Se-PSO/LADRC

Mohammed Kdair Abd^{1*} Luay G. Ibrahim¹ Firas M. F. Flaih²

¹Electrical Engineering Department, University of Technology-Iraq, Baghdad 10066, Iraq

²State Company of North Distribution Electricity, Ministry of Electricity, Baghdad 10013, Iraq

* Corresponding author's Email: mohammed.k.abd@uotechnology.edu.iq

Abstract: Incorporating renewable energy storage systems in power grids has presented significant challenges in maintaining a stable power generation structure and load frequency within interconnected grids. A promising solution to support the reliable and safe operation of the power system is the use of pumped storage units because of their excellent adjustment characteristics, including fast power response and convenient start and stop features. To optimize the performance of the pumped storage system, this article proposes the implementation of a linear-adaptive disturbance rejection controller (LADRC) in conjunction with the segmentation particle swarm optimization (Se-PSO) algorithm for parameter tuning. This article establishes a precise hybrid load frequency control (LFC) model for a two-area interconnected power grid incorporating pumped storage power plants (PSPP). It determines the optimal LADRC parameters for varying load disturbances in different areas of the power grid. The proposed control method systematically simulated pumping and power generation conditions in a PSPP. Simulation results indicate that the proposed method enhances dynamic stability by approximately 85%, offering greater anti-disturbance ability and adaptability than the traditional proportional-integral (*PI*) controller.

Keywords: Pumped storage, LADRC, Segmentation PSO, LFC, Parameter setting, Disturbance.

1. Introduction

Due to the development of energy structures for electrical power generation, especially with the expansion of renewable energy generation systems, it notices that the proportion of the energy storage system (ESS) and access to the interconnected power grid has increased yearly. The intermittent ESS characteristics impact the power system quality that cannot be ignored. The ESS is vital in successfully integrating renewable energy sources like photovoltaic (PV) and wind farms into power grids. The ESS achieves this by regulating the output power of PV and wind plants, improving the stability of the power system, and ensuring its safe and reliable operation [1, 2].

The increasing scale of electrical power generation has brought new challenges to frequency stability will reduce the power quality [3]. Adding renewable energy resources (RERs) and electric

vehicles discussed in reference [4, 5] will bring unstable factors to the frequency response [6]. To reduce their harmful effects, the LADRC control based on the intelligent algorithm is designed for decision-making ability and to eliminate load disturbance, unknown disturbances, and uncertainty of RERs.

Frequency stability is a crucial technical indicator that reflects power quality. The LFC systems are extensively utilized in interconnected power grids to regulate frequency stability, enhance power quality, and minimize exchange power deviation between areas to zero [7]. However, incorporating demand response, as explored in reference [8], can improve system reliability and frequency stability in renewable energy resources (RERs). In [9] proposed a novel active disturbance rejection control (N-ADRC) method that considers external and internal disturbances as an expanded new state variable, leveraging the linear extended

state observer (LESO) to estimate the effect and utilizing error state feedback rate to control it. The N-ADRC approach eliminates the need for a complete specific model of the controlled object and disturbance, requiring only two relevant parameters [10]. Power electronic equipment and nonlinear loads in A.C. microgrids can lead to harmonic distortion.

To mitigate this problem, using LADRC to control the fundamental current at the point of standard coupling is recommended. In addition, an active power filter can be added to eliminate the harmonic currents generated by the nonlinear loads. This combined approach can help ensure the microgrid operates efficiently and within the required regulatory standards [11].

In the field of LFC, numerous advanced control methods have been proposed to address the challenge of maintaining system stability amidst varying loads and frequency disturbances. One such approach involves exploring the potential of using doubly-fed induction machines (DFIM) based pumped storage hydro (PSH) to provide the necessary support and stability during frequency disturbances [12]. This approach has been widely discussed in the literature. Researchers have investigated various ways to implement and optimize this method for LFC, such as model predictive control to adjust the power system frequency stability [13], dual-mode fuzzy [14], parallel fuzzy *PI* with conventional *PD* [15, 16], hybrid neuro-fuzzy controller of multi-area deregulated power system [17], and segmentation particle swarm optimization for a single area of power system [18], etc.

In [19], the authors proposed a PSO-based dual mode fractional order (PDMFOPI) controller to overcome the LFC problem in two area interconnected hybrid systems. The authors discussed and compared the proposed PDMFOPI control strategy with the PSO-tuned fractional-order proportional-integral (PFOPI) controller and the POS-tuned dual mode proportional-integral (PDMPI) controller to realize the controller advantages. Moreover, a differential evolution artificial electric field algorithm (DE-AEFA) is proposed to tune the controller parameters, while a classical PID controller is used as the secondary controller. The DE-AEFA algorithm is first applied to a test system consisting of two non-reheat thermal turbines in two areas and then extended to a combined model to investigate the combined LFC and automatic voltage regulation problem [20].

However, the current article on the LFC problem of interconnected power grids with various

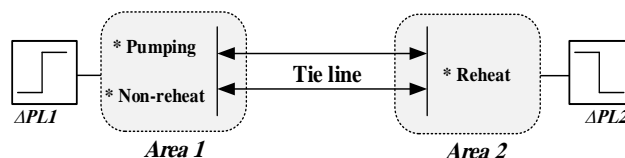

Figure. 1 Single line diagram of two areas LFC model

generating units, such as PSPP, is still scarce. There are deficiencies, such as complex control algorithms, difficult tuning of controller parameters, and poor adaptability.

Our study highlights the potential of PSPP to contribute to the frequency regulation of power grids. By proposing a new control strategy, we ensure stable and reliable grid operation in the face of external disturbances. In this article, the features and contributions are listed as follows:

- Designing a dynamic model of an LFC system with hybrid power generation in a two-area interconnected power grid with PSPP. The LFC is based on a second-order LADRC method for each area.
- A new intelligent controller using the Se-PSO algorithm to find optimal adjustable parameters of the second-order LADRC and improve its performance.
- The simulation system will be employed to analyze the fluctuation suppression of the main physical quantities of the interconnected power grid caused by the external load disturbance, considering that the PSPP operates under two working conditions pumping and power generation.
- Accuracy criteria are used to evaluate the proposed model's performance. This article's prediction accuracy requirements included the integral square error (*ISE*).
- Dynamic stability of the LADRC system of the interconnected power grid also is studied for the two operating modes of the PSPP conditions.
- The obtained results from the proposed models will be compared with previously published research papers.

Fig. 1 clarifies a single-line diagram of a two-area LFC model; area-1 contains PSPP; the prime mover is a non-reheat steam turbine. The prime mover in area-2 is a reheat steam turbine. Finally, the unit model of the doubly-fed variable speed with a PSPP is selected and established.

This article will be organized as follows; section 2 presents the pumped storage power plants models, hybrid LFC dynamic models. Section three introduced the proposed method and problem formulation model. In section four, we presented an

analysis of the results and implementation steps of the proposed approaches, including a study of two cases. In addition, we compared the results with previously published articles. Lastly, conclusions and future work is given in section five.

2. Considered system

2.1 Pumped storage power plants model

Currently, PSPs are a practical, more mature way of indirectly storing electrical power, which can play the role of peak-cutting and valley-filling in the power grid to achieve a bidirectional flow of electrical power. This ESS boasts two operating modes: pumping and generating [21]. When electricity demand is low, surplus power is channeled into the system through pumping, efficiently storing it for future use. Essentially, this system takes advantage of power demand downtimes to build up excess energy reserves.

During the peak power demand season, water is released to generate electricity, which supplements the power and realizes the power generation balance between the demand sides. The output of this PSPP can be controlled at the optimal operating speed. Compared to a conventional fixed-speed PSPP, the generator of this power system has a lower minimum output capacity. This unique feature enables improved power output and enhanced power generation efficiency [22]. A detailed model of the PSPP, under both pumping and power generation conditions, is illustrated in Fig. 2. The PSPP does not need to consider the impact of the water hammer effect. Therefore, the water turbine model and governor model in the pumped-storage unit are reasonably simplified and combined, expressed as:

$$G_p = \frac{K_T}{s^2 + \left(\frac{1}{T_T} + \frac{1}{T_G}\right)s + \frac{1}{T_T \cdot T_G}} \quad (1)$$

where K_T , is the characteristic constant of the turbine and the governor, T_T and T_G , are time constants of the turbine and governor, respectively. The power of the rotor with the vector-controlled adjustable speed device can be provided by the rotor's kinetic energy equation, which is:

$$\Delta P_{ep} = \frac{J}{2} \times \Delta \omega_r \quad (2)$$

According to the two different operating modes of PSPP, the input power ΔP_H , can be expressed as a two-stage model:

$$\Delta P_H = \begin{cases} \Delta P_{Gen} = \Delta P_{op} - \Delta P_{ep} \\ \Delta P_{Mot} = \Delta P_{op} - \Delta P_{ep} \end{cases} \quad (3)$$

where ΔP_{ep} , is the electric power of the rotor, ΔP_{op} , is the output power of the prime mover, and ΔP_{ipwp} , is the input power of a water pump.

2.2 Hybrid LFC dynamic model

The hybrid LFC dynamic model includes a secondary frequency controller such as a conventional governor, a prime mover, and an ESS such as a flywheel, compressed air, and PSPP. The use types of LFC are more in line with the interconnection grid's actual status. Assume that area-1 contains a power plant model, including a steam turbine and PSPP, and area-2 is only a steam turbine system and its system hybrid dynamic model in Fig. 3. The relationship between the power difference and the frequency deviation in area-1 can be expressed as:

$$\Delta P_{m1}(s) - \Delta P_{L1}(s) - \Delta P_{tie}^{12}(s) + \Delta P_H(s) = M_1 \cdot s \cdot \Delta f(s) + D_1 \cdot \Delta f_1(s) \quad (4)$$

The relationship between the power difference and the frequency deviation in area-2 can be expressed:

$$\Delta P_{m2}(s) - \Delta P_{L2}(s) - \Delta P_{tie}^{12}(s) = M_2 \cdot s \cdot \Delta f(s) + D_2 \cdot \Delta f_2(s) \quad (5)$$

In this context, several variables come into play, including ΔP_m , which denotes the mechanical power difference of each area, ΔP_L , which represents the load change, Δf indicating the frequency deviation of each control area, ΔP_{tie}^{12} , which measures the exchange power deviation between the two areas, and M and D , which signify the machine inertia and load damping coefficient, respectively. Additionally, ΔP_H is stands for the input power of the PSPP, while the tie-line represents the electrical transmission line between the interconnected areas. By neglecting line losses, the tie-line load flow model between area-1 and area-2 can be expressed as follows:

$$\Delta P_{tie}^{12} = \frac{2\pi T_{12}}{s} (\Delta f_1 + \Delta f_2) \quad (6)$$

In a network of interconnected power grids, maintaining the frequency stability of each area alone is insufficient. Retaining the power exchange between the areas at the desired level is crucial. Area control error (ACE) is the conventional method to

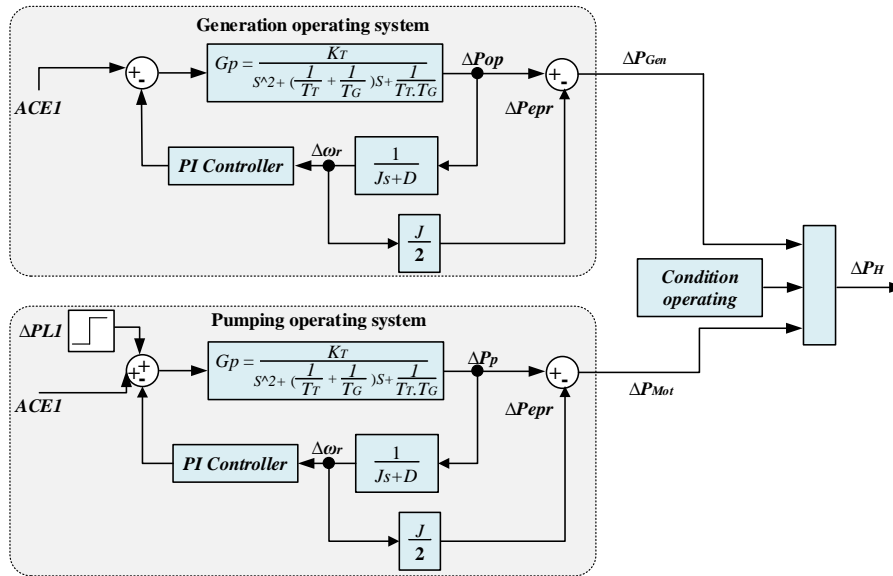

Figure. 2 The PSPP model

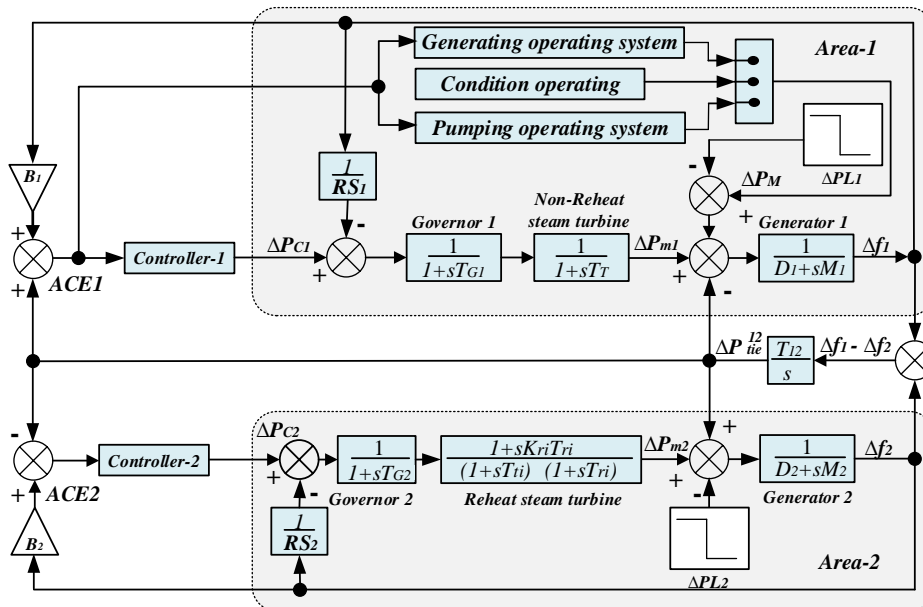

Figure. 3 Hybrid LFC model (two-area interconnected power grid system)

account for these two aspects while providing input to the LFC controller.

It is calculated using a linear combination of the frequency and tie-line power deviations between two interconnected areas [16, 17]. Its linear combination formula is:

$$ACE_i = B_i \Delta f_i + \Delta P_{tie}^i \quad (7)$$

$$B_i = \int_{j=1}^{N_i} \frac{1}{RS_{ij}} + D_i \quad (8)$$

where B_i , indicates the frequency regulation parameter in the area- i , and RS_{ij} is the speed regulation constant of the governor.

The LFC system performance is evaluated by

treating the ACE as the output to determine any deviation between energy generation and load requirements. In the LFC problem, the value of the performance index should be as (Y) minimum as possible for better system performance. The integral square error (ISE) index is selected as the objective function to estimate the performance of the LFC system as follows [19]:

$$Y_{ISE} = \int_0^T [(\Delta f_i)^2 (\Delta P_{tie}^{12})^2] dt \quad (9)$$

Fig. 4 shows the structure of the LADRC controller [10, 23], which has three parameters b_0 , ω_0 , and ω_c will need to tune by Se-PSO. Therefore, for the two area interconnected power

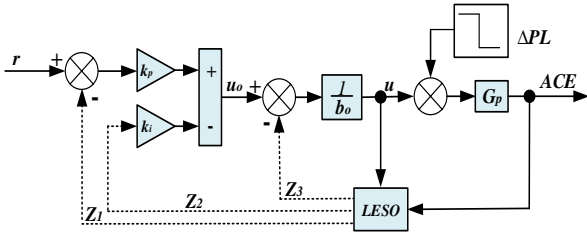

Figure. 4 Schematic diagram of LADRC for the interconnected grid system

grids, the two controllers need to set six parameters [10] at the same time using the Se-PSO algorithm.

The linear combination of PI controllers can be composed as:

$$u_0 = k_p(r - z_1) - k_i \cdot z_2 \quad (10)$$

where r is the set of bandwidths for the controller value $k_p = \omega_c^2$, $k_i = 2\omega_c$. The k_p and k_i are electrical governors proportional and integral gains.

3. Proposed method

3.1 The Se-PSO algorithm

The PSO algorithm is one of the most commonly used optimization methods in energy system stability. Generally, the PSO was inspired by behaviors like searching honey bees, food of fish, group foraging of bacteria, echolocation of microbats for bats, or a flock of birds in a D-dimensional search space [24, 25].

The segmentation method is a concept that involves dividing the PSO group into multiple searching groups, or segments, to improve search efficiency. Each segmentation operates as an independent evolutionary algorithm that strives to converge on a global optimal point. By dividing the PSO group into segmentations, the overall search process becomes more organized and focused, with each segment responsible for exploring a specific portion of the search space.

This approach allows for more thorough search space exploration and can lead to improved convergence on optimal solutions [18]. In essence, the segmentation method utilizes the strengths of PSO, namely its ability to explore large search spaces effectively and converge on global optima while also introducing a level of organization and structure to the search process.

In this paper, the Se-PSO algorithm is used to tune the parameters of LADRC, which enhances the operability and practicability of the control method. The Se-PSO algorithm finds the optimal value of the

cost function by continuously changing each particle's speed and position according to the requirements of the cost function. The particle swarm update speed and position are as follows:

$$\begin{cases} v_{ij}(t+1) = w \cdot v_{ij} + c_1 \cdot rand(0,1) \\ \quad (p_i(t) - x_{ij}(t)) + c_2 \cdot rand(0,1) \\ \quad \cdot (g(t) - x_{ij}(t)) \\ x_{ij}(t+1) = x_{ij}(t) + v_{ij}(t+1) \end{cases} \quad (11)$$

$$Best\ segment = best\ x_{ij} \mp segment\ length/2 \quad (12)$$

where, ω is an inertia factor, c_1 and c_2 are acceleration constants, j is the number of segments, and also a learning factor for each particle; $p_i(t)$ and $g(t)$ are the individual optimal value and the optimal global value of the particle, respectively.

3.2 Problem formulation

The system-controlled object with a disturbance can be modeled as follows:

$$Y(s) = G(s) \cdot U(s) + D(s) \quad (13)$$

where, $Y(s)$ is the output-system, $U(s)$ is the input-system, and $D(s)$ is the total disturbance, including the internal and $G(s)$ external disturbances of the system. The transfer function of a system is [26]:

$$G(s) = \frac{b_m s^m + b_{m-1} s^{m-1} + \dots + b_1 s + b_0}{a_n s^n + a_{n-1} s^{n-1} + a_1 s + a_0} \quad n \geq m \quad (14)$$

The system LADRC controller can be expressed as [16]:

$$y^r = bu + f(y, \dot{y}, \dots, y^{r-1}, u, \dot{u}, \dots, u^{r-1}, d) \quad (15)$$

where $f(y, \dot{y}, \dots, y^{r-1}, u, \dot{u}, \dots, u^{r-1}, d)$ is total system disturbance. The LESO is the core segment of the full LADRC, is used to evaluate disturbances and $(y, \dot{y}, \dots, y^{r-1})$ as follows:

$$\begin{cases} z_1 = y \\ z_2 = \dot{y} \\ \dots \\ z_r = y^{r-1} \\ z_{r+1} = f(y, \dot{y}, \dots, y^{r-1}, u, \dot{u}, \dots, u^{r-1}, d) \end{cases} \quad (16)$$

This article uses two-area interconnected power

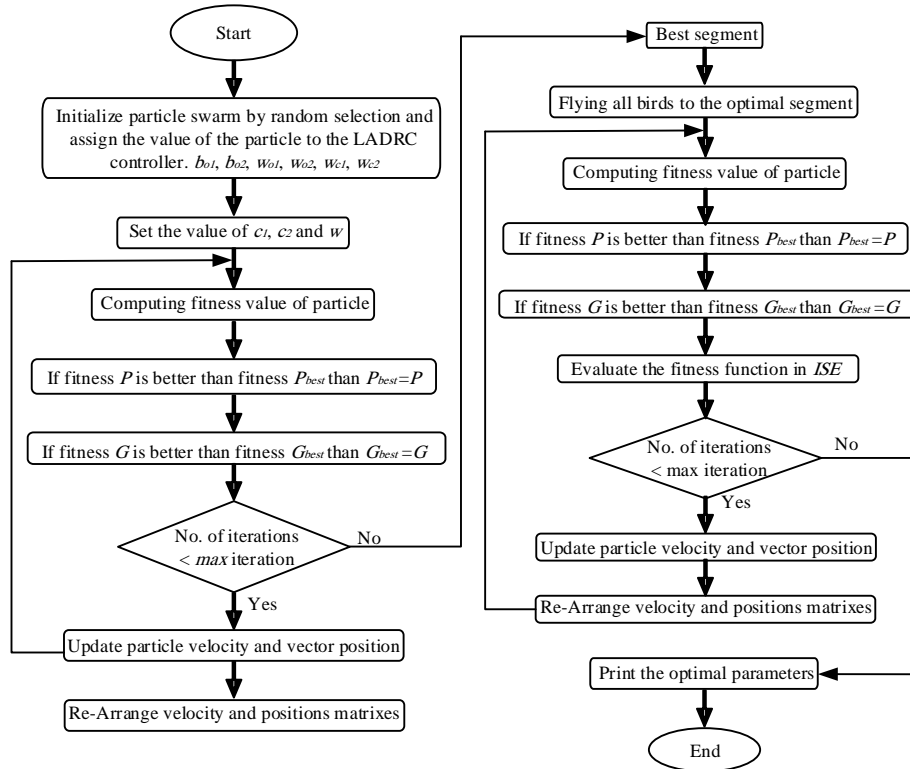

Figure. 5 Proposed Se-PSO algorithm for parameter tuning of the LADRC controller

grid models, area-1 is a power plant model including a steam turbine and pumped storage, and area-2 is only a steam turbine system. The mathematical model of the second-order system can be obtained from the following equations [16]:

$$\dot{y} = b_0 u + I \tag{17}$$

$$\text{which is: } \begin{cases} \dot{x}_1 = x_2 \\ \dot{x}_2 = b_0 u + x_3 \\ \dot{x}_3 = h \\ y = x_1 \end{cases} \tag{18}$$

Assuming that x_1, x_2, x_3 are the state variables of a system and $h = I$; we can obtain the estimated values of y, \dot{y} , and I by using the second-order expression of the LSEO as follows:

$$\begin{cases} \dot{z}_1 = z_2 - \beta_1(z_1 - y) \\ \dot{z}_2 = z_3 - \beta_2(z_1 - y) + b_0 u \\ \dot{z}_3 = -\beta_3(z_1 - y) \end{cases} \tag{19}$$

The following equations can express the observer bandwidth (parameters gain coefficient) of LESO:

$$\begin{cases} \beta_1 = 3w_0 \\ \beta_2 = 3w_0^2 \\ \beta_3 = w_0^3 \end{cases} \tag{20}$$

Table 1. Two-area interconnected power grid system parameters

Parameter	Area-1	Area-2
Area inertia (M)	0.2017	0.1247
Load damping (D)	0.016	0.015
Tie-line synchronization factor (T_{12})	0.12	0.12
Frequency regulation factor (B_I)	0.3692	0.3827
Speed regulation factor (R_S)	2.82	2.73
Governor time (T_G)	0.07	0.09
Non-reheat turbine time (T_T)	0.30	0.30
Low-pressure reheating time of reheating turbine (T_{rh})	7.0	0.30

Fig. 5 shows the proposed Se-PSO algorithm for the LADRC parameter tuning and optimization. The Se-PSO is used to optimize the six parameters in the two LADRC controllers for the approximate solution.

4. Result and discussion

The simulation is performed according to the LFC system model of the two-area interconnected power grid with PSPP shown in Figs. 2 and 3. The LFC system model parameters are shown in Table 1. The dynamic response control simulation for the system performance was carried out under different working conditions. For area-1, the load step

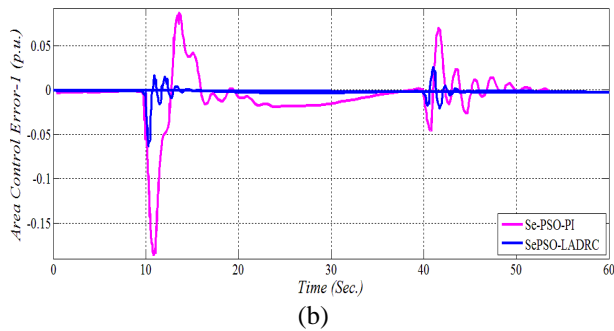
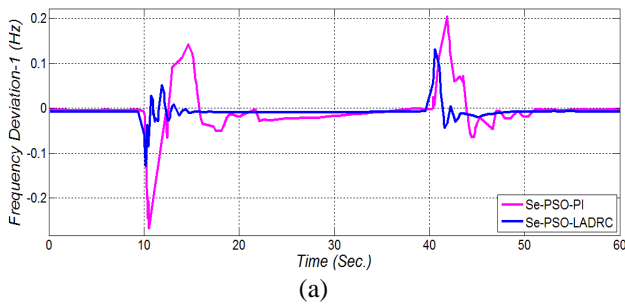

Figure. 6 Area-1 under pumping mode: (a) Frequency deviation response and (b) ACE response

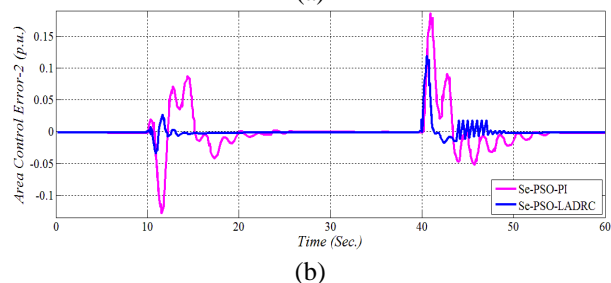
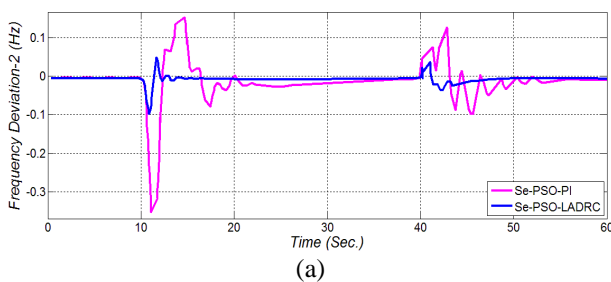

Figure. 7 Area-2 under pumping mode: (a) Frequency deviation response and (b) ACE response

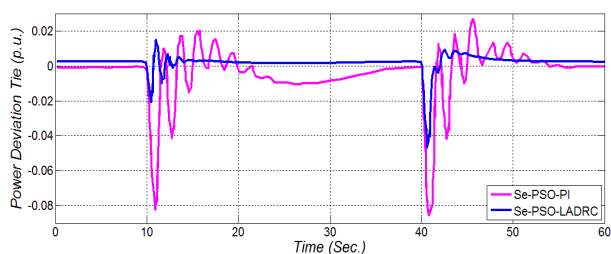

Figure. 8 Exchange power deviation response of tie-line under pumping mode

disturbance was set as $-0.18 pu$ occurs at time 10 sec, and for area-2, the load step disturbance was set as $0.165 pu$ occurs at time 40 sec. The traditional PI controller and LADRC controller tunes were applied

to the LFC of two-area interconnected power grids with PSPP. To make a fair comparison and effectively verify the superiority of the designed LFC, the parameters of LADRC and traditional PI controllers are tuned and optimized using the Se-PSO algorithm.

4.1 Pumped energy storage in pumping conditions

When a PSPP is in pumping operation condition, it will stop pumping according to the occurrence of area control deviations and load disturbances, participate in the frequency adjustment of the power grid, and transmit its available power to the power grid. Fig. 6 to Fig. 8 show the response curves of the frequency deviation, control deviation, and exchange power deviation of the connection lines in the two areas.

Fig. 6 to Fig. 8 show the effect of large load disturbance occurring in the power grid under pumping conditions; both controllers can maintain the dynamic stability of the system and eliminate the fluctuations caused by the load disturbance within a certain period. However, when the traditional PI controller is used, the overshoot of the system response is significantly more significant. It takes a longer adjustment time to reach stability, threatening the interconnected grid frequency and active power stability. In addition, the LADRC controller significantly reduced the system overshoot response, and the system response is quickly restored to stability, and the disturbance suppression capability is more significant.

4.2 Pumped energy storage in generation conditions

When a PSPP operates in power generation conditions, it can augment the power generation capacity of the system, thus ensuring that the power supply and demand are promptly balanced. The response curves of the main physical quantities of the power grid obtained by system simulation are shown in Fig. 9 to Fig. 11, respectively.

From Fig. 9 to Fig. 11, it is evident that when the PSPP operates in power generation mode, both types of controllers effectively maintain the power grid's stability despite load disturbances originating from various locations. During this period, the PSPP contributes to the power grid by supporting the system's stability. Compared with the traditional PI control, the dynamic response performance indicators of the system under the LADRC controller have apparent advantages.

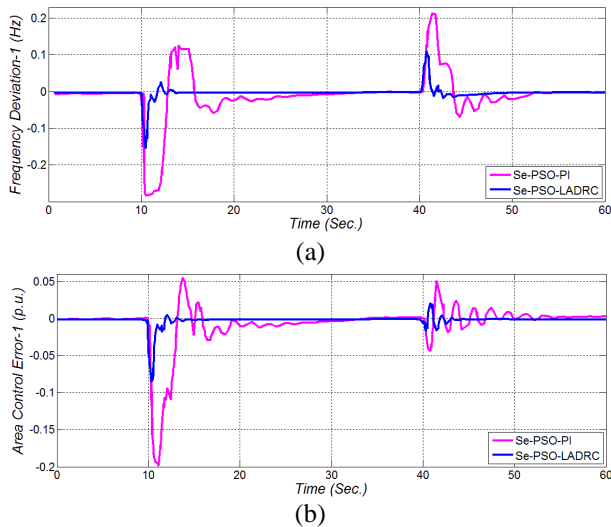

Figure. 9 Area-1 pump storage under generating mode: (a) Frequency deviation response and (b) ACE response

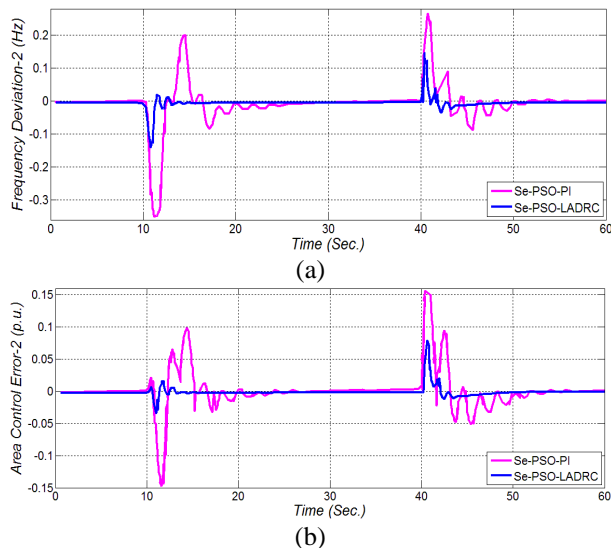

Figure. 10 Area-2 pump storage under generating mode: (a) Frequency deviation response and (b) ACE response

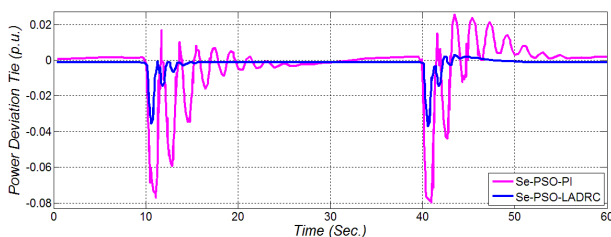

Figure. 11 Exchange power deviation response of tie-line under generating mode

LADRC based on Se-PSO parameter tuning can make the system quickly suppress load disturbances for about 4 seconds, the system response can return to stable, converge to zero, the adjustment time is shortened significantly, and the overshoot is slight. Through the system mentioned above, LFC simulation, and analysis, it can be confirmed that the

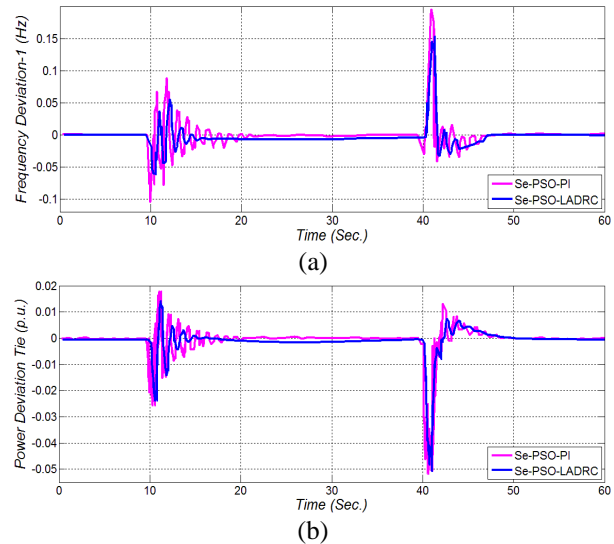

Figure. 12 Area-1 under pumping mode: (a) Frequency deviation response and (b) Exchange power deviation response

two area interconnected power grids connected to the PSPP, whether the power plant is operating in pumping or power generation conditions, the system is in the optimal LADRC controller designed. Under the action, it can achieve a superior LFC effect. Compared with the traditional *PI* controller, the former has more robust adaptability and can achieve better dynamic response performance.

4.3 Final comparison

To assess the effectiveness of PSPP in regulating the power grid frequency, we conducted system control simulations and compared the performance of these plants under different operating conditions. Specifically, we examined the frequency deviation and tie-line exchange power deviation response curves of area-1 under pumping conditions, as shown in Fig. 12.

Our analysis of Fig. 12 reveals that when operating in pumping mode, connecting a PSPP to the power grid has no adverse effects on the grid's stability. It can even help reduce area frequency deviation and mitigate external load disturbances.

Furthermore, variations in the exchange power deviation on the tie-line can enhance the dynamic response characteristics of the system. To summarize, our findings indicate that PSPP possesses the capability to efficiently engage in frequency regulation of the power grid and promote its reliable operation.

In Fig. 13, the frequency deviation response and the line exchange power deviation response curves for area-2 are depicted under power generation conditions. It is evident that the power deviation

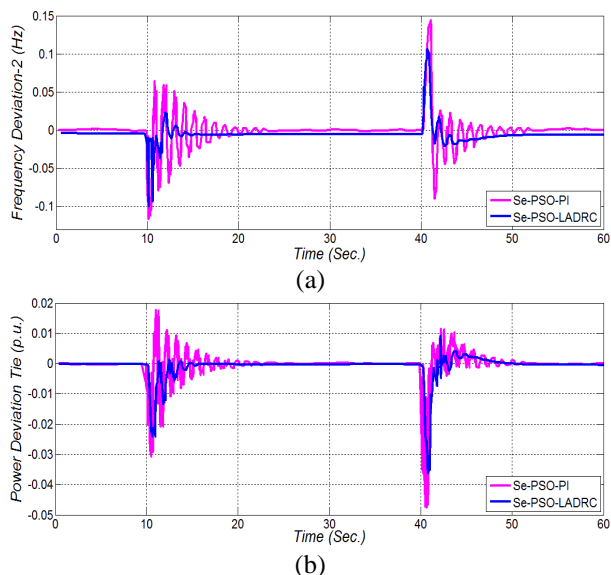

Figure. 13 Area-2 under generating mode: (a) Frequency deviation response and (b) Exchange power deviation response

response quickly converges to zero, and the oscillations are significantly reduced.

This outcome can effectively suppress the system response fluctuations that result from external load disturbances, thereby improving the frequency and power stability of the power grid's operation. Overall, Fig. 13 demonstrates that the proposed control method effectively enhances the power system's performance under power generation conditions.

In addition, to make a quantitative analysis of the performance of the PSPP when the system uses different controllers to perform LFC under different operating conditions, the calculated values of the *ISE* objective functions of other controllers under varying operating conditions are shown in Table 2.

The results show that compared with the *PI* controller based on Se-PSO tuning, the LADRC controller based on Se-PSO tuning designed in this article can achieve smaller *ISE* adaptive values under different operating conditions. This shows that the controller parameter optimization adjustment by the Se-PSO algorithm makes the LADRC controller have better self-adaptability. Because the LADRC controller can estimate and effectively suppress the total system interference, it can obtain a better performance than the *PI* controller. The control performance is more suitable for the LFC of the interconnected power grid, and the tedious manual adjustment of parameters based on experience is eliminated, which makes the design of the active disturbance rejection LFC more reference value and practical significance.

Not only that, for the grid-connected PSPP under

Table 2. The values of (*ISE*) objective function for different controllers under different working conditions

Power grid status	Operating conditions	<i>ISE</i>	
		Se-PSO /PI	Se-PSO /LADRC
Connected pumped storage	Pumping	0.02964	0.00594
	Generation	0.01829	0.00273
Non-pumped storage	----	0.02778	0.0087

Table 3. Performance index (*ISE*) of different controllers

Controller Type	<i>ISE</i>	Controller Type	<i>ISE</i>
Se-PSO /PI	0.01829	DE [20]	25.7325
PFOPI [19]	0.11062	AEFA [20]	23.478
PDMPI [19]	0.6057	DE-AEFA [20]	12.416
PDMFOPI [19]	0.0084	Se-PSO /LADRC	0.00273

the power generation condition, the *ISE* adaptation value of the LADRC controller is the smallest, which also verified that the PSPP played a more significant role in participating in the frequency regulation of the power grid under the power generation condition. This shows that PSPP can quickly respond to sudden changes in load and have excellent fast frequency regulation capabilities, especially in power generation conditions. Therefore, PSPP can significantly promote the safe and stable operation of the power grid.

Table 3 shows the controller performance index obtained by the suggested Se-PSO/LADRC controller, compared with previous works that used DE, AEFA, DE-AEFA, PFOPI, PDMPI, and PDMFOPI algorithms. The results indicate that the Se-PSO/LADRC controller has a minimum *ISE* value of 0.00273, demonstrating its superior performance in enhancing the power system's efficiency under power generation conditions. These findings provide strong evidence for the effectiveness of the proposed control method.

5. Conclusion

This article focuses on optimizing the LFC control strategy in a two-area interconnected power grid with PSPP. The study involves developing a dynamic LFC model and designing a second-order LADRC controller for each area. This article proposes a LADRC strategy for load frequency regulation in interconnected power grids with PSPP. The adjustable parameters of the second-order LADRC controller are optimized using the Se-PSO

algorithm, and simulations show the effectiveness of the proposed strategy in handling different step load disturbances and in both pumping and power generation modes of the PSPP.

The results show that the load frequency linear auto-disturbance optimization control strategy based on the Se-PSO tuning can make the system exhibit superior dynamic response performance, save the tediousness of manual parameter adjustment, and have strong adaptability. In addition, it proves that the PSPP has a good frequency regulation function.

The Se-PSO/LADRC method provides superior dynamic quality and adaptability compared to traditional *PI* control. Furthermore, the *ISE* rate is reduced by around 85%. In conclusion, PSPP can play a vital role in LFC for the power grid.

In our future work, we will study the impact of different types of PSPP on LFC. Also, the PSPP can help stabilize the grid but can also be expensive. A cost-benefit analysis could help determine if the benefits of using pumped storage for LFC outweigh the costs.

Conflicts of interest

“The authors declare no conflict of interest.”

Author contributions

“Conceptualization, M. K. Abd; methodology, M. K. Abd and F. M. F. Flaih; software, M. K. Abd; validation, M. K. Abd; formal analysis, M. K. Abd and F. M. F. Flaih; investigation, Luay G.; resources, Luay G.; data curation, F. M. F. Flaih; writing—original draft preparation, M. K. Abd; writing—review and editing, Luay G. and F. M. F. Flaih; visualization, M. K. Abd.; supervision, M. K. Abd; project administration, M. K. Abd.”

References

- [1] P. Mukherjee, and V. V. Rao, “Superconducting Magnetic Energy Storage for Stabilizing Grid Integrated with Wind Power Generation Systems”, *Journal of Modern Power Systems and Clean Energy*, Vol. 7, No. 2, pp. 400-411, 2019.
- [2] A. Pfeifer, V. Dobravec, L. Pavlinek, G. Krajačić, and N. Duić, “Integration of Renewable Energy and Demand Response Technologies in Interconnected Energy Systems”, *Energy*, Vol. 161, pp. 447-455, 2018.
- [3] Z. Li, X. Li, and B. Cui, “Planar Clouds Based Load Frequency Control in Interconnected Power System with Renewable Energy”, *IEEE Access*, Vol. 6, pp. 36459-36468, 2018.
- [4] Y. Zheng, J. Tao, Q. Sun, H. Sun, Z. Chen, and M. Sun, “Deep Reinforcement Learning Based Active Disturbance Rejection Load Frequency Control of Multi-area Interconnected Power Systems with Renewable Energy”, *Journal of the Franklin Institute*, 2022.
- [5] N. Taghizadegan, F. Babaei, and A. Safari, “A Linear Active Disturbance Rejection Control Technique for Frequency Control of Networked Microgrids”, *Energy Systems*, pp. 1-20, 2023.
- [6] M. Chakib, T. Nasser, and A. Essadki, “Comparative Study of Active Disturbance Rejection Control with RST Control for Variable Wind Speed Turbine Based on Doubly Fed Induction Generator Connected to the Grid”, *International Journal of Intelligent Engineering and Systems*, Vol. 13, No. 1, pp. 248-258, 2020, doi: 10.22266/ijies2020.0229.23.
- [7] K. Liu, J. He, Z. Luo, H. Shan, C. Li, R. Mei, Q. Yan, X. Wang, and L. Wei, “Load Frequency Control of Pumped Storage Power Station Based on LADRC”, *Processes*, Vol. 8, No. 4, p. 380, 2020.
- [8] A. Saxena, R. Shankar, S. K. Parida, and R. Kumar, “Demand Response Based Optimally Enhanced Linear Active Disturbance Rejection Controller for Frequency Regulation in Smart Grid Environment”, *IEEE Transactions on Industry Applications*, Vol. 58, No. 4, pp. 4337-4349, 2022.
- [9] W. R. A. Adheem, A. T. Azar, I. K. Ibraheem, and A. J. Humaidi, “Novel Active Disturbance Rejection Control Based on Nested Linear Extended State Observers”, *Applied Sciences*, Vol. 10, No. 12, p. 4069, 2020.
- [10] Y. Yang, L. Xiang, X. Guo, and Y. Zheng, “Introducing LADRC to Load Frequency Control Model with Pumped Storage Power Station Considering Demand Response”, pp. 610-615, *IEEE, Chinese Automation Congress (CAC)*, 2019.
- [11] H. Li, S. Li, J. Lu, Y. Qu, and C. Guo, “A Novel Strategy Based on Linear Active Disturbance Rejection Control for Harmonic Detection and Compensation in Low Voltage AC Microgrid”, *Energies*, Vol. 12, No. 20, p. 3982, 2019.
- [12] S. Nag, K. Y. Lee, D. Suchitra, and V. Mediratta, “Load Frequency Control through DFIM-based Pumped Storage Hydro”, *IEEE Power & Energy Society General Meeting (PESGM)*, pp. 1-5, 2019.
- [13] J. Yang, X. Sun, K. Liao, Z. He, and L. Cai, “Model Predictive Control-based Load

- Frequency Control for Power Systems with Wind-turbine Generators”, *IET Renewable Power Generation*, Vol. 13, No. 15, pp. 2871-2879, 2019.
- [14] S. K. Sahoo, G. Sharma, A. Panwar, and R. C. Bansal, “Frequency Regulation of Wind Integrated Power System using Dual Mode Fuzzy”, *Energy Procedia*, Vol. 158, pp. 6321-6327, 2019.
- [15] A. S. Jaber, A. Z. Ahmad, and A. N. Abdalla, “A New Load Frequency Controller based on Parallel Fuzzy PI with Conventional PD (FPI-PD)”, *International Journal of Electrical and Computer Engineering*, Vol. 7, No. 2, pp. 101-106, 2013.
- [16] A. T. Hammid, M. Hojabri, M. H. Sulaiman, A. N. Abdalla, and A. A. Kadhim, “Load Frequency Control for Hydropower Plants using pid Controller”, *Journal of Telecommunication, Electronic and Computer Engineering (JTEC)*, Vol. 8, No. 10, pp. 47-51, 2016.
- [17] B. S. Solaiappan and N. Kamaraj, “Hybrid Neuro Fuzzy Controller for Automatic Generation Control of Multi Area Deregulated Power System”, *Circuits and Systems*, Vol. 7, No. 4, pp. 292-306, 2016.
- [18] A. S. Jaber, A. Z. Ahmad, and A. N. Abdalla, “A new Parameters Identification of Single Area Power System Based LFC using Segmentation Particle Swarm Optimization (SePSO) Algorithm”, *IEEE PES Asia-Pacific Power and Energy Engineering Conf. (APPEEC)*, pp. 1-6, 2013.
- [19] S. A. Pavadaisami, M. T. A. Musthafa, and V. K. N. Jeganathan, “Particle Swarm Optimization Based Dual-Mode Fractional Order Control for Automatic Generation Control of Two Area Interconnected Hybrid System”, *International Journal of Intelligent Engineering and Systems*, Vol. 15, No. 4, pp. 86-96, 2022, doi: 10.22266/ijies2022.0831.09.
- [20] N. S. Kalyan and G. S. Rao, “Frequency and Voltage Stabilisation in Combined Load Frequency Control and Automatic Voltage Regulation of Multiarea System with Hybrid Generation Utilities by AC/DC Links”, *International Journal of Sustainable Energy*, Vol. 39, No. 10, pp. 1009-1029, 2020.
- [21] H. Zhang, P. Guo, and L. Sun, “Transient Analysis of a Multi-unit Pumped Storage System During Load Rejection Process”, *Renewable Energy*, Vol. 152, pp. 34-43, 2020.
- [22] Y. Xu, C. Li, Z. Wang, N. Zhang, and B. Peng, “Load Frequency Control of a Novel Renewable Energy Integrated Micro-grid Containing Pumped Hydropower Energy Storage”, *IEEE Access*, Vol. 6, pp. 29067-29077, 2018.
- [23] W. Tan, Y. Hao, and D. Li, “Load Frequency Control in Deregulated Environments via Active Disturbance Rejection”, *International Journal of Electrical Power & Energy Systems*, Vol. 66, pp. 166-177, 2015, doi: 10.1016/j.ijepes.2014.10.036.
- [24] R. H. A. Rubayi, M. K. Abd, and F. M. Flaih, “A New Enhancement on PSO Algorithm for Combined Economic-emission Load Dispatch Issues”, *International Journal of Intelligent Engineering and Systems*, Vol. 13, No. 1, pp. 77-85, 2020, doi: 10.22266/ijies2020.0229.08.
- [25] M. K. Abd, S. J. Cheng and H. S. Sun, “A New MBF-PSO for Improving Performance of DFIG Connected to Grid under Disturbance”, *IEEE PES Asia-Pacific Power and Energy Engineering Conf. (APPEEC)*, pp. 408-413, 2016.
- [26] L. Dong, Y. Zhang, and Z. Gao, “A Robust Decentralized Load Frequency Controller for Interconnected Power Systems”, *ISA Transactions*, Vol. 51, No. 3, pp. 410-419, 2012.