

DESIGN AND EXPERIMENT OF A VERTICAL ROTARY TILLAGE MACHINE WITH FIXED-LAYER FERTILIZATION FUNCTION

立式旋耕定层施肥机的设计与试验

Wei CHEN¹⁾, Yan DING^{1*)}, Norbu TASHI²⁾, Jiping ZHU¹⁾, Dong YUAN¹⁾, Keheng YAO¹⁾, Min XIA¹⁾, Lijuan SUN³⁾ ¹

¹⁾Nanjing Institute of Agricultural Mechanization, Ministry of Agriculture and Rural Affairs, Nanjing / China;

²⁾Tibet Academy of Agricultural and Animal Husbandry Sciences, Lhasa / China;

³⁾Agricultural Mechanization General Station, Ministry of Agriculture and Rural Affairs, Beijing / China

Tel: +86 025-84346278-68; E-mail: ding8967@126.com

DOI: <https://doi.org/10.35633/inmateh-67-03>

Keywords: Vertical rotary tillage, fixed fertilization layer, EDEM

ABSTRACT

In this paper, we designed a vertical rotary tillage machine with fixed-layer fertilization function and introduced the designing process in detail. The fertilization performance was verified by EDEM software simulation. The final field test shown that the average tillage depth could reach 26.8 cm; the fertilizer layer was concentrated under the soil surface at 45-48 mm; the width of the fertilizer layer was 238-240 mm; the thickness of the fertilizer layer was 223-226 mm, which satisfied the design requirements.

摘要

本文设计了一种立式旋耕定层施肥机，介绍了设计过程，采用 EDEM 软件仿真验证了施肥性能。最后田间试验表明，平均耕深可达 26.8cm；肥层集中在土下 45-48mm；肥层宽度为 238-240mm；肥层厚度为 223-226mm，符合设计要求。

INTRODUCTION

Compared with the horizontal rotary tiller, the vertical rotary tiller has the following obvious advantages:

(1) *The disturbance to soil caused by rotary work is small.* According to analysis of the motion trajectory of the rotary tiller, the soil does not move much in the vertical direction, and maintains the original position basically during the vertical rotary tillage operation. For farmland with plowing operations, vertical rotary tillage is recommended, which can maintain the plowing effect (Wang Liyang et al., 2023; Tang Wenbo, 2022). On the contrary, horizontal rotary tillage will bring the lower soil back to the bottom layer, which reduces the plowing effect. Also, vertical rotary tillage has the effect of maintaining moisture and supposes less tillage.

(2) *The plowing depth is large and the soil crushing effect is better.* Due to its own structural characteristics, the vertical rotary cultivator has a large working depth, which is useful to shredding ridges and deep plowing operations (NIE Sheng-Wei et al., 2021). Fertilizer has a very important role in agricultural production. Unfortunately, the utilization rate of it in our country is very low, which is about 40%. Such a low utilization rate will inevitably lead to the excessive use followed by waste of resources and environmental pollution. How to improve the utilization rate of chemical fertilizers has always been a research hot spot. In order to improve the utilization rate of chemical fertilizer, from the perspective of fertilization technology, Chinese experts proposed layered fertilization.

Fertilizer has a very important role in agricultural production. It can improve crop yield and ensure food security (Abbas A, Zaman Q U, Schuman A W, 2014). The utilization rate of chemical fertilizers in our country is very low, and the comprehensive utilization rate is about 40% (Chunhong Xiao et al., 2021). Such a low utilization rate will inevitably lead to the excessive use of chemical fertilizers, followed by waste of resources and environmental pollution. How to improve the utilization rate of chemical fertilizers has always been a problem. In order to improve the utilization rate of chemical fertilizers, from the perspective of fertilization technology, Chinese experts put forward the technology of base fertilizer deep application (HE Ping et al., 2014).

¹ Wei Chen, PHD student; Yan Ding, ASP; Norbu Tash, ASP; Jiping Zhu, Pro; Dong Yuan, SN ENGR; Keheng Yao, ASP; Min Xia, ENGR; Lijuan Sun, ENGR.

At present, the commonly used fertilization methods are soil surface fertilization, mixed seed fertilization, strip fertilization and hole fertilization, and the sowing depth of most crops is about 3 cm, while the soil moisture above 3 cm is easy to decrease. Under the action of the hydrotropism growth law of plants, the seeds take root downward, and the shallow soil layer fertilizer is prone to waste.

Most of the mechanized fertilization is spreading basal fertilizer, sowing and applying seed fertilizer, and top dressing at the seedling stage. Spreading base fertilizer is to spread the fertilizer on the surface, and turn the fertilizer into the soil through plowing (Xu P., Yang X.J. et al., 2022). During the operation, the fertilizer is easy to fall at the bottom of the plow, and the phenomenon of fertilizer accumulation is easy to occur, resulting in unreasonable distribution of soil and fertilizer. In most cases, sowing and fertilizing for germination are carried out at the same time, but the applied seeding fertilizer can only meet the initial stage of crop growth, and it is easy to burn the seedlings. A lot of research has been done on fertilizer deep applicators in China. In order to improve the fertilization method of crops and the depth and precision of fertilization, He Fengyu et al. developed a quantitative deep fertilizer applicator for corn, vegetables, cotton and other crops, with simple structure and reliable performance, which could improve the utilization rate of chemical fertilizer by about 25% (Zhao Jin, 2012). He Yichuan et al designed a deep applicator for cotton base fertilizer, with an average depth of 19.9 cm (He Yi-Chuan et al., 2019).

In this paper, a vertical rotary tillage-deep fertilizing machine was designed. The machine completed vertical rotary work and basal fertilizer fertilization at the same time. According to the growth requirements of different crops, the position of the fertilization port was designed to control the fertilization depth, which could avoid the waste of shallow fertilizer. Under the action of the vertical rotary blade, the fertilizer was evenly distributed in the depths of the soil, which was conducive to the dissolution and absorption of the fertilizer.

MATERIALS AND METHODS

Whole structure design

The overall design of the machine was shown in figure1.

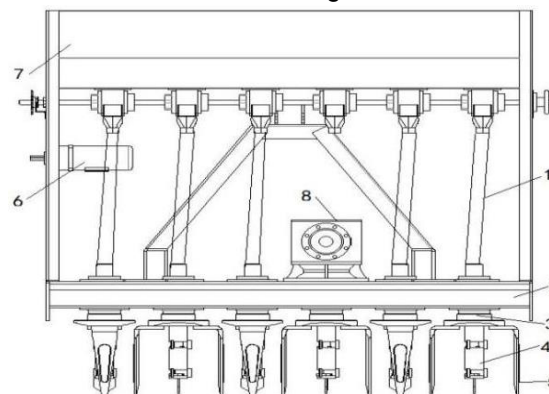

Fig. 1 - Overall structure

1 - Fertilizer pipe; 2 - Transmission box of working parts; 3 - Cutter (fertilizer shaft); 4 - Fertilizer; 5 - Vertical rotary blade; 6 - Fertilizer motor; 7 - Fertilizer box; 8 - Power input box

Transmission scheme design

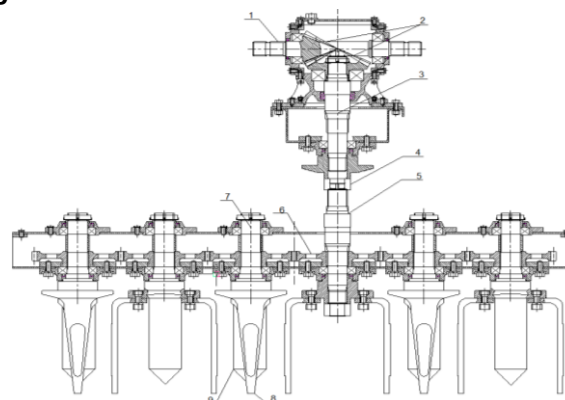

Fig. 2 - Transmission scheme diagram

1 - Power input shaft; 2 - Bevel gear; 3 - Central shaft; 4 - Coupling; 5 - Central shaft; 6 - Spur gear; 7 - Hollow guide shaft; 8 - Vertical rotary tiller; 9 - Separate fertilizer device

Power from tractor transfer to the machine's central transmission box through its output shaft. The central box had a pair of cone gear making up the transmission and changing direction structure, changing the horizontal movement to vertical movement passing to the box to drive the working parts. Each working unit was composed of two vertical rotary knives, a fixed layered fertilizer. The vertical rotation knife and fertilizer were rotated at the same time by a hollow shaft, which was also fertilization pipe.

Design of key components

Rotary axis speed design

The power consumption of working components showed a drastic growth relationship with the increase of the rotating speed of the knife axis. In order to ensure the efficiency of the operation and reduce the power consumption, the matching method of increasing the tractor's speed and reducing rotary speed was generally adopted.

$$\frac{60V_m}{ZS_{max}} \leq n \leq \frac{60V_m}{ZS_{min}} \tag{1}$$

where:

n was knife shaft rotation speed, [r/min]; V_m was the advance speed, determined by actual work speed, [m/s]; S was the cutting distance, determined by the machine's structural parameters, [cm]; Z was the number of installed knives.

According to the calculation values and the existing gear parameters, we determined that rotating speed was 282 r/min finally.

Fixed layer fertilizer design

In order to ensure that the fertilizer could be evenly distributed in the fixed layer of the soil, the upper and lower outlet of fertilizer were designed, and the amount of them was designed to 1:1. During working, it was a random event that the fertilizer particles continuously fall into the fertilizer port, and the probability of the particles falling into any position of the fertilizer port was equally, which could only be determined by the area of fertilizing channel entrance. Research group designed a kind of half-cone and half-cup structure to allocate fertilizer. The fertilizer could be imported in upper layer channel by the half-cone or in lower layer channel by the half-cup.

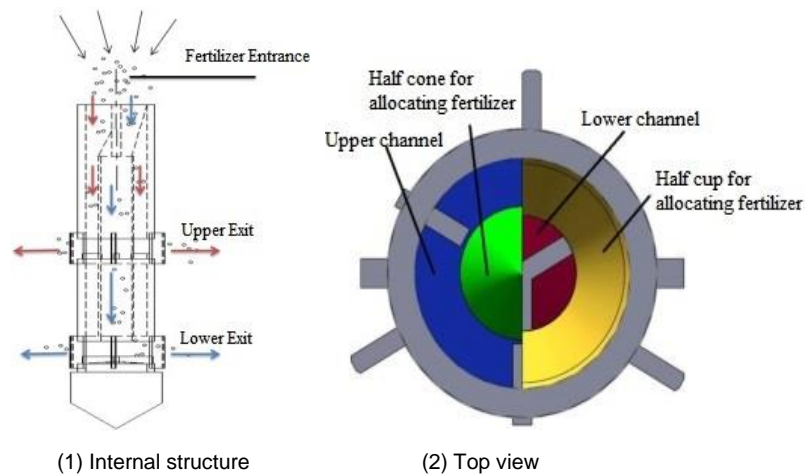

Fig. 3 - Structure of fertilizing unit



Fig. 4 - Composition of fertilizing unit

For the rotary cultivator, we could select a suitable standard vertical rotary knife according to the needs of the operation depth. Each knife shaft was equipped with two rotary knives and one fixed-layer fertilizer applicator, as shown in figure 5. During the working process of the machine, the vertical rotary tillage fertilization mechanism could accurately apply fertilizer to the seed layer and below, avoiding the shortage of fertilizer as the picture (a) and the waste of fertilizer as the picture (b).



Fig. 5 - Working unit

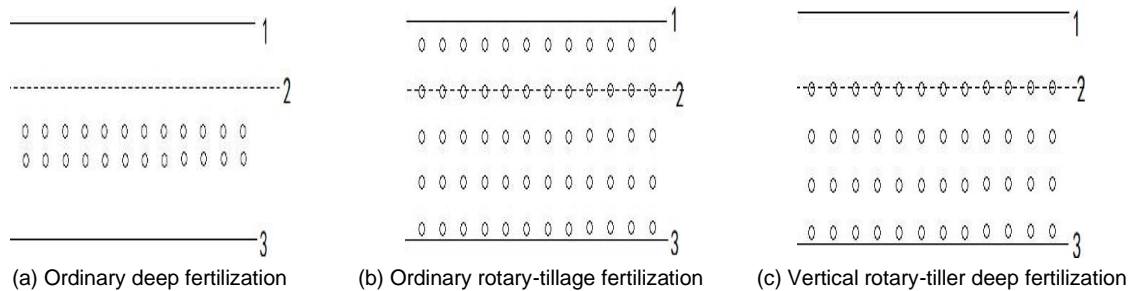

Fig. 6 - Fertilizer effect in different ways

1 - Soil surface; 2 - Seed layer; 3 - Bottom layer

Rotary axis strength check calculation

During the operation, the most loaded part was the cutter shaft. When the rotary tiller was working, the cutter shaft would be resisted by the soil, and the cutter shaft in this machine was designed as a hollow shaft for fertilization. Therefore, it was necessary to check the strength of the cutter shaft.

$$T_{max} = 9549 \times \frac{P}{n} \tag{2}$$

where:

- T_{max} was maximum torque, [Nm];
- P was input power (36.8 kW);
- n was rotating speed (282 r/min);

According to the information, the torsional section modulus of the thin-walled hollow shaft was:

$$W_p = \frac{\pi D^3}{16} (1 - \alpha^4) \tag{3}$$

where:

- W_p was the torsional section modulus, [mm³];
 - D was the outer diameter of the shaft (D=45 mm);
 - α was the ratio of inner diameter to outer diameter of the shaft ($\alpha=d/D=30/45$).
 - d was the inside diameter of the shaft (d=35 mm).
- So, the maximum shear stress of the shaft was:

$$\tau_{max} = \frac{T_{max}}{W_p} = 124.6 \text{ [MPa]} \tag{4}$$

T_{max} was much smaller than the allowable shear stress of 65 Mn steel, which was 600 MPa, conforming to the strength requirement.

Simulation

EDEM software was used for simulation analysis. According to the information, the average equivalent diameter of granular compound fertilizer was 3.65 mm, and the sphericity was 91.91% (Chen Y., Munkholm L.J., Nyord T., 2013; Ramírez González-Montellano et al., 2011). The dry-incompressible soil module was adopted to simulate, which was included in EDEM software.

Table 1

Material parameters			
Material	Density	Poisson's ratio	Shear modulus
	[kg/m ³]		[MPa]
Steel	7830	0.35	72700
Fertilizer	0.001575	0.25	12.48

Table 2

Collision restitution coefficient	
Contact type	Value
Fertilizer to fertilizer	0.3074
Fertilizer to steel	0.3555

Table 3

Contact parameters		
Name	Static friction coefficient	Rolling friction coefficient
Fertilizer to fertilizer	0.372	0.3
Fertilizer to steel	0.314	0.306

Simulation design of the effect of falling fertilizer angle on the working performance of the fertilizer applicator

In the simulation process, four kinds of fertilizer center positions were designed to analyze the effect of falling fertilizer angle on the amount of fertilizer in the upper and lower layers.

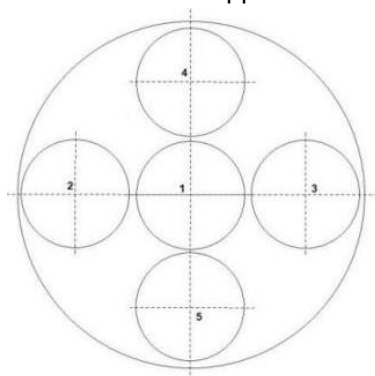

Fig. 7 - Location distribution of fertilization centers

- 1 - The fertilization center coincides with the rotation center;
- 2 - The fertilization center was to the left of the rotation center;
- 3 - The fertilization center was to the right of the rotation center;
- 4 - Fertilizer center was above the rotation center;
- 5 - The fertilization center was below the rotation center

Field test

In order to verify the field operation performance of the machine, research team conducted a field test in Shanzhuang Village, Danyang City, Jiangsu Province on August 31, 2021. The test field was 50 meters long, 30 meters wide, wasteland, with an absolute moisture content of 22.86% and a hardness of 1460 kPa. It was equipped with a tractor Jiangsu-500 (36.8kW), and fertilizers were round pellets. During the experiment, the working speed and fertilization position were mainly measured.



Fig. 8 - Test photos

RESULTS

Simulation Result

Influence of falling fertilizer angle on working performance of fertilizer applicator

We analyzed the situation of the above four different fertilization positions. For the convenience of statistics, in the process of simulation, the total number of fertilizer particles and the lower layer fertilizer particles were counted, and the statistical results were as follows:

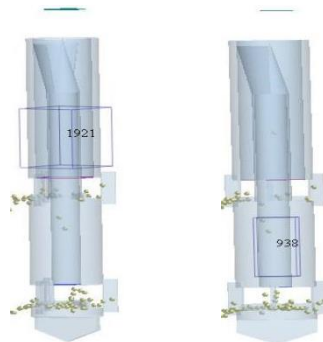

Fig. 9 - Fertilizer Statistics

Table 4

Fertilizer Particle Number Statistics

Serial number	Total number	Number of particles in the lower layer	Number of particles in the upper layer
1	1710	800	910
2	1888	926	962
3	1921	938	983
4	1685	854	831
5	1868	899	969

(Note: The meaning of the serial number was the same as in Figure 7)

The above four simulation results shown that the fertilizers passing through the upper and lower channels were the same basically, which could prove that the falling angle of fertilizer particle did not affect the performance of the fertilizer applicator.

Analysis of the performance of submerged single unit under different working speeds

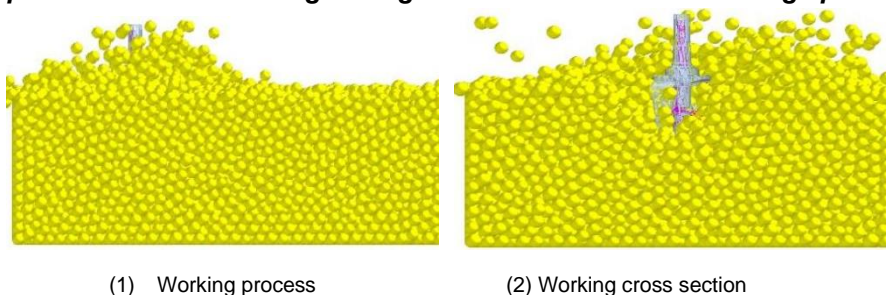

Fig. 10 - Fertilizer distribution under soil

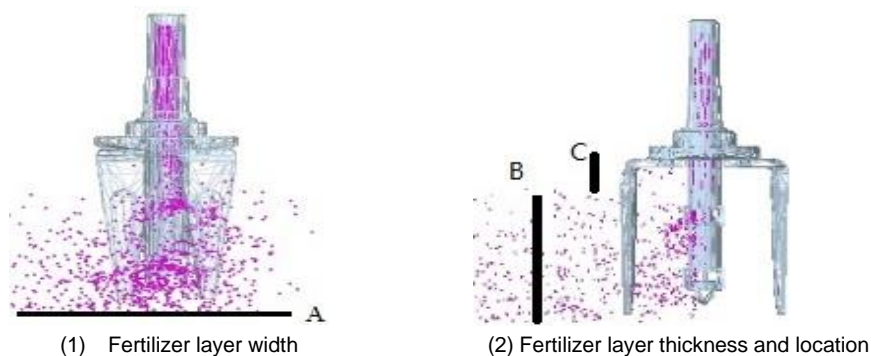

Fig. 11 - Fertilizer distribution under soil

Table 5

Fertilization effect				
Serial number	Speed	A-Fertilizer layer width	B-Fertilizer layer thickness	C-Fertilizer layer location
	[m/s]	[mm]	[mm]	[mm]
1	1.5	242	221	50
2	2	244	223	50
3	2.5	243	224	50

The above data shown that the single unit of rotary tillage and fertilization designed in this paper had a tillage depth of up to 270 mm, the position of the fertilizer layer was 50 mm below the soil, and the fertilizer was evenly distributed, in the speed of 1.5-2 m/s.

Field test result

During the test, the working speed (1.5 m/s, 2 m/s, 2.5 m/s), tillage depth and fertilization effect, including fertilizer layer width, fertilizer layer thickness, fertilizer layer location, were mainly measured. We repeat three times for each working speed and the above parameters were measured at 6 collection points every time, taking the average value.

Table 6

Field test result				
Working speed	Tillage depth	Fertilizer layer		
		width	thickness	location
[m/s]	[cm]	[mm]	[mm]	[mm]
1.5	26.5	238	223	45
2	27.4	237	227	51
2.5	26.6	240	226	48

According to Table 6, the minimum tillage depth was 26.5 cm and the maximum value was 27.4 cm. There is only a small difference between them indicating that the operating speed did not affect the tillage depth. When the working speed was 1.5 m/s, the fertilizer layer was concentrated below 45 mm under the soil surface, which was quite different from the simulation results. It could be explained that the soil disturbance during the actual operation could not be the same as the simulation calculation. The average value of the soil layer position under the three speeds was 48 mm, which was similar to the simulation result. The thickness and width of the fertilizer layer were basically the same as the simulation calculation, which was consistent with the designed structure. Therefore, the vertical fixed-layer fertilization equipment designed satisfied the design requirements and could meet the requirements of the big plowing depth and the fertilization operation in fixed layer.

CONCLUSIONS

In this paper, a vertical rotary tiller with the function of fixed-layer fertilization was designed, which integrated advantages of vertical rotary tillage and fixed-layer fertilization. EDEM was used to establish a simulation model of fertilizer particles and fertilizer applicators, completing the performance analysis of the fertilizer applicator, and verifying that the angle of falling fertilizer did not affect the performance of the fertilizer applicator. The discrete element model of the single unit in the soil was established to verify the performance of the single unit. The results showed that the single unit in the soil could meet the requirements of rotary tillage and fertilization, and the fertilizer was evenly distributed in the soil layer below 5 cm. Field experiment was carried out to verify simulation result and structure performance.

Discussion

Compared with the traditional horizontal rotary tillage, the vertical rotary tillage had less soil disturbance, which could effectively improve the soil erosion resistance. The fixed-layer fertilization technology could effectively improve the fertilizer utilization rate. The working unit designed in this paper did not necessarily meet the agronomic requirements of other crops, but could change the structural parameters to meet different agronomic requirements.

ACKNOWLEDGEMENT

This work was supported by the National Key R&D Program of China (2021YFD1000301), Research on Key Technologies of Highland Barley Germplasm Creation and Quality Improvement (XZ2021NA01), China Agriculture Research System of MOF and MARA, Basic Scientific Research Service Fee of Chinese Academy of Agricultural Sciences (Grant No.S202001-02).

REFERENCES

- [1] Abbas A, Zaman Q U, Schuman A W. (2014). Effect of split variable rate fertilization on ammonia volatilization in wild blueberry cropping system. *Applied Engineering in Agriculture*, Vol. 30, pp. 619-627.
- [2] Chen Y, Munkholm L J, Nyord T. (2013). A discrete element model for soil sweep interaction in three different soils. *Soil & Tillage Research*, Vol. 126, pp. 34-41, Netherlands.
- [3] Chunhong Xiao, Qingbao Guan, Weifang Xiao, Jinfu Wang, Shengxu Gao. (2021). Research and development of intelligent stratified fertilization equipment for winter wheat. *Agricultural machine*, Vol. 8, pp. 92-93+96, Beijing/China.
- [4] Ramírez González-Montellano., Gallego E., et al. (2011). Validation and experimental calibration of 3D discrete element models for the simulation of the discharge flow in silos. *Chemical Engineering Science*, Vol. 66, pp. 5116 – 5126, USA.
- [5] He Ping, Xu Xinpeng, Qiu Shaojun et al. (2014). Yield response and economic analysis of fertilizer application in maize grown in North China. *Journal of Plant Nutrition and Fertilizer*, Vol.20, pp.1387 – 1394, Beijing/China.
- [6] He Yi-Chuan, Tang Zhi-hui, Wen Hao-jun, Zheng Xuan, Li Jian – jun, Yang Huai-jun, Liu Jin-bao, Zhao Yan. (2019). Design and Experiment of Cotton Basal Fertilizer Alignment row Spacing and Stratified Fertilizing Machine. *Xinjiang Agricultural Science*, Vol. 56, pp. 528-536, Xinjiang/China.
- [7] Nie Sheng-wei, Zhang Hao-guang, Zhang Qiao-ping, et al. (2021). Effects of vertical rotary tillage on wheat yield and soil compaction during wheat growing seasons. *Journal of Agricultural Resources and Environment*, Vol. 38, pp. 36-42, Tianjin/China.
- [8] Tang Wenbo, Liu En guang, He Chao, Jin Cong, Liu Cunxiang. (2022). Design and Experiment of Vertical Rotary Cultivator. *Journal of Agriculture Mechanization Research*, Vol. 44, pp. 77-81+87, Haerbin/China.
- [9] Wang Liyang, Yang Fazhan, LI Weihua, Jiang Fulin, Jian Shichun. (2023). Simulation Research on the Performance of Vertical Rotary Tillage Cutter Based on Discrete Element Method. *Journal of Agriculture Mechanization Research*, Vol. 45, pp. 9-20, Haerbin/China.
- [10] Xu P, Yang X J, Feng Z L, Sun Y L, Yang Z, Zhang X Q, Deng X B, Shi J Y, Zhang Z B. (2022). Yield-and efficiency-increasing effect of new tillage-fertilization-sowing method on wheat in the North China Plain. *Chinese journal of Eco-Agriculture*, Vol. 30, pp. 831-841, Shijiazhuang/China.
- [11] Zhao Jin (2012). *Study on the Precise Plant with No-tillage Subsoil and Whole Layer Fertilization*. [Unpublished master's thesis, Hebei Agricultural University], Hebei/China.