

Nadogradnja sistema za hlađenje vodom sa mogućnostima ispiranja

Upgrading a Water Cooling System with Flushing Possibilities

Valentino Stojkovski, Viktor Iliev, Filip Stojkovski

“Ss. Cyril and Methodius” University, Faculty of Mechanical Engineering, Skopje, Republic of North Macedonia

Rezime - U ovom radu je data analiza radnih parametara sistema za hlađenje vodom strukturnog dela peći za pripremu valjaonica. Strukturno rešenje rashladnog sistema izvodi se kao protočno, sa stalnim prilivom sveže vode i odvodom iz sistema. Ugrađene su četiri uzdužne cevi koje podržavaju vertikalni nosači. Vertikalni nosači treba da obezbede toplotnu stabilnost kako bi se osigurala horizontalnost cevi-ploča. Vertikalni nosači se redovno povezuju sa rashladnim sistemom postavljanjem cevi direktno u vertikalni nosač, koji zahvata deo vodovoda koji hladi vertikalni nosač, a ista voda se vraća u sistem za hlađenje i kontinuirano prenosi na sledeći nosač. Tokom rada, zbog kvaliteta rashladne vode koja nije hemijski tretirana, nastaje kalcijum karbonat; prisutne nečistoće začepljuju protočne kanale sistema za hlađenje u vertikalnim nosačima. Primenom CFD analize otkrivaju se uslovi proticanja vode u rashladnom sistemu vertikalnih nosača. Nakon analize dobijenih rezultata, predlaže se nadogradnja postojećeg sistema ugradnjom sistema za ispiranje, koji će obezbediti usmeren i kontrolisan dotok u zonama rashladnog sistema. U radu su prikazani idejno rešenje sistema za ispiranje i efekti njegovog rada.

Ključne reči - rashladni sistem, CFD analize, sistem za ispiranje

Abstract - This paper presents an analysis of the operating parameters of a water cooling system of the structural part of a furnace for rolling mills preparation. The structural solution of the cooling system is performed as flow, with a constant inflow of fresh water and drainage from the system. Four longitudinal pipes are installed, which are supported by vertical girders. Vertical girders should provide thermal stability to ensure pipe-plate horizontality. The vertical girders are regularly connected to the cooling system by placing pipes direct into the vertical girder, which engages the part of the water supply that cools the vertical girder, and the same water is returned to the cooling system and continuously transferred to the next girder. During operation, due to the quality of cooling water that is not chemically treated, calcium carbonate is formed; the presented impurities clog the flow channels of the cooling system in the vertical girders. The application of CFD analysis reveals the conditions of water flow in the cooling system of vertical girders. From the analysis of the obtained results, it is proposed to upgrade the existing system by installing a flushing system, which will ensure a directed and controlled inflow in the zones of the cooling system. The conceptual solution for the flushing system and the effects of its operation are given in this paper.

Index Terms - cooling system, CFD analyses, flushing system

I INTRODUCTION

The system for providing thermal stability of the system for extraction of the weak from the furnace, in relation to the constructive part, is projected two-stage cooling (fig.1):

- First degree - through longitudinal pipes (along the entire length of the space) for cooling (total of 4 longitudinal lines with variable cross section of the pipes by zones),
- Second stage - through a transversely placed cooling system, projected with 13 rows of transverse pipes connected in 5 independent circulating cooling water systems.

There are 13 pipes installed in the transverse horizontal cooling system. On each transverse pipe, four supporting columns are placed with their subsystem for cooling, ie a total of 52 girders. Transverse cooling pipes are divided into five independent sections as follows (fig.1.):

- One cooling section with serially connected four (4) transverse pipes,
- One cooling section with three (3) transverse pipes connected in series,
- Three cooling sections with serial connected two (2) transverse pipes.

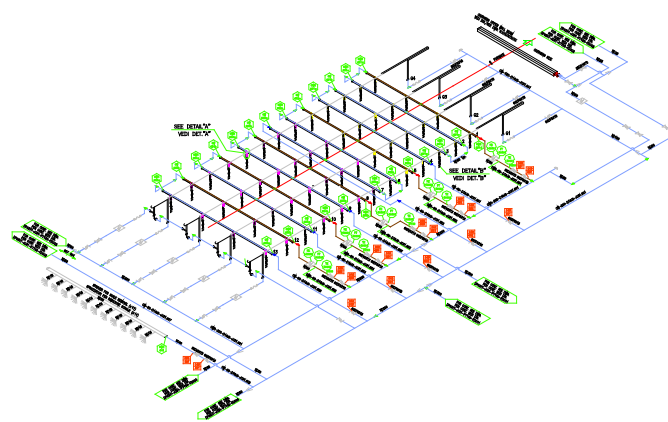

Figure1. Conceptual solution of the cooling system of furnace

The cooling water supply is provided from a common collector pipe, and the water outlet from each section is in a common collector pipe. The transverse pipe cooling system is designed to

continual flow. Cooling water is provided through the central technological water supply system (fig.1.).

Structurally, the second cooling stage is performed with vertically placed pipes (girder-columns) to ensure structural stability of the system and for the cooling of the second stage, it is designed to provide a hydraulic self-balancing distribution of the flow of cooling water supply from the transverse horizontal cooling system. The applied concept of the technical solution for providing cooling of the vertical girders (columns) in the system, as well as the effect is directly dependent on the flow of water to the sectional transverse horizontal part of the system. The flow of cooling water in the part of the vertical bearing pipes, is provided by placing a sub-assembly with a pipe for diversion (capture) of water from the supply water, to the transversely placed sections of pipes of the system. By diverting part of the water to the vertical (load-bearing) structural pipe, cooling (thermal) stability of the structure should be ensured. The preferred solution of the vertical column cooling subsystem is given in the figure 2.

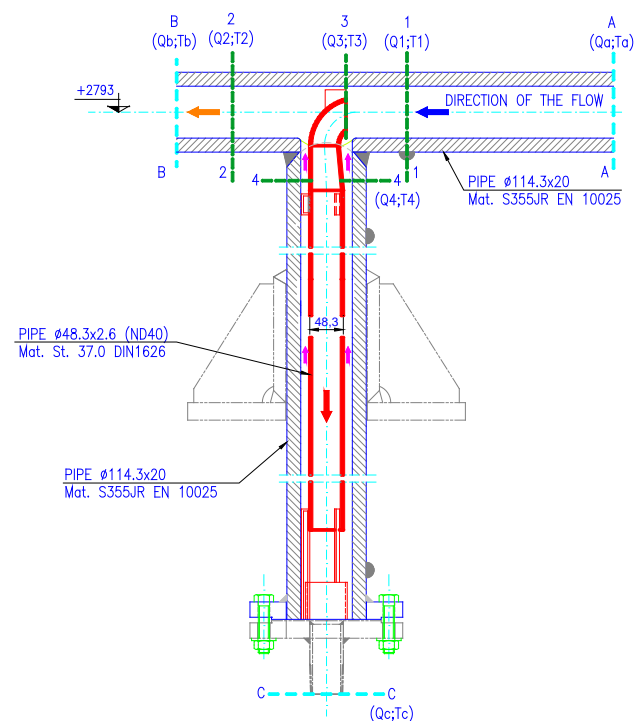

Figure 2. Construction of vertical girder-cooling system

In the space of the vertical bearing pipe $\phi 114,3 \times 20$ (connected to the transverse horizontal pipe), a (inserted) construction of a steel pipe $\phi 48,3 \times 2,6$ is placed, which at one end (from the upper side) is placed against the fluid flow, inserted in the space of the horizontal transverse cooling pipe $\phi 114,3 \times 20$ from the system, and from the lower side is provided water drainage in a closed space. The formed closed space allows the water to return to the system through the space between the outer wall of the inserted pipe and the inner wall of the pipe-column (ring surface) and the same to return it to the system.

The conceptual solution of the cooling system of the vertical girder establishes a continuous flow of water with temporary redirection of cooling water, ie it allows part of the supply water

to be redirected to the vertical girder (through the inside of the inserted pipe), so that water (return) is directed along the wall of the support pipe of the girder (which provides cooling) and it mixes again with the supply water from the horizontal transverse cooling pipe and flows in one direction to the next support column.

During the operation of the system, inconsistencies were found in the part of thermal stability in the vertical girders of the system where the following should be provided:

- Required amount of water for flowing in the vertically placed girders,
- Ensuring uninterrupted conditions for cooling the supply water in the space of the girders,
- Fulfilling the design conditions of the water flow system in the vertical supports (girders) in the system.

During the revision of the condition of the vertical girder from the transverse circulation system of the cooling water, damage to the pipes was noticed, fig.3. It can be noticed that a scale has formed in the space between the inner surface of the outer supporting pipe and the outer surface of the inserted pipe which should ensure the cooling of the cooling water in the vertical column. As a possible reason for the situation is the reduced speed of cooling water in that area and allowing the start of the process of scale formation, which led to complete clogging of the cooling system, its non-functionality and damage.



Figure 3. Damages occurred at the vertical girders



Figure 4. Intervention for increasing flow in girders

During the operation of the furnace, an increase in temperature was noticed in the vertical columns and in order to provide more intensive cooling water, the bottom of the vertical columns was upgraded by placing a quick coupling behind the second ball valve and fire hose, through which the water is taken directly to the collection tank for drainage water from the furnace cooling

systems. This solution of direct flow of cooling water is applied to all vertical girders, fig.4.

The idea for upgrading the cooling with extracting water at the bottom side of the girder was implemented with the aim to increase the fluid flow.

II IDENTIFICATION OF RESEARCH

The researches arise as a result of the occurred damages in the cooling system at girders, in order to establish the flow of water in the cooling system in a uniform direction, with controlled intensity of the flow rate in certain zones in the structure of the carrier, which should achieve the following conditions:

- operation of the existing system to remain undisturbed
- possibility of cleaning the sediment by rinsing with leaking water
- service conditions for assembly and disassembly to remain unchanged

III NUMERICAL ANALYSES

By applying numerical calculation (CFD-technique) a system analysis was performed in the following conditions:

- To define the hydraulic characteristic of the constructive solution of the cooling system in the vertical girder,
- To define the impact of the reduced elbow placement from the inserted tube in position of counter-flow (front inflow) and position of same-flow (back inflow),
- To define the conditions that are achieved when establishing a direct outflow flow through the vertical girder at bottom side,
- To provide a variant solution to improve the cooling system of vertical girder. The analyzed variant states in which the flow current can be brought in the vertical girder in the current space (inside) of the inserted pipe and in the space between the bearing pipe and inserted pipe,

provide establishment of a technical solution that provides unambiguous flow-technical parameters in system operation.

Numerical calculations are performed using CFD technology. The FLUENT software package is used. The following conditions are given in the model:

- model: 3D fluid flow domain
- fluid: water
- regime: stationary
- turbulent model: k-epsilon
- initial conditions: inlet velocity in the system (different intensity)
- output conditions of the system: pressure
- in the zone of support of the longitudinal pipe with the transverse horizontal pipe, an area is defined by setting the temperature of the wall of the pipe

The numerical calculations cause different cooling technical parameters (states) of the cooling system in the vertical girder, on the basis of which an analysis of the fluid flow field in the system is performed, defined by the arrangement of the velocity vectors in individual parts, as well as defining the direction of the distribution of water flows in the current space.

A) Working Conditions

Having in mind that in the transverse cooling system there are vertical columns where the constructive cooling solution is by redirecting part of the supply water, and the way of redirection is by placing the inner (inserted) pipe for front water inflow, ie with back inflow. The hydraulic conditions provided by these two different systems for diverting water to the vertical girder are comparatively given through comparison charts obtained for the same given calculated operating conditions (for the same flow of water) and the same pre-calculated boundary conditions of the system.

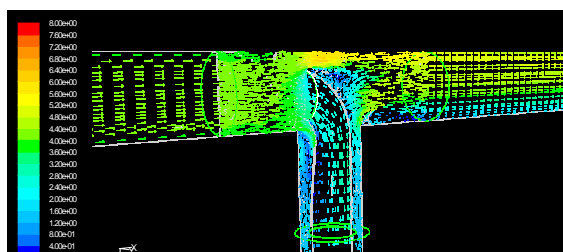

a) frontal inflow – reduced elbow

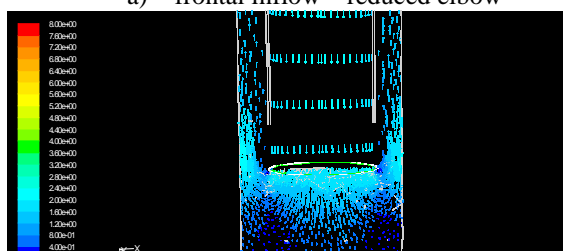

b) frontal inflow – closed bottom

Figure 5. Flow conditions in the girder with frontal inflow position of reduced elbow

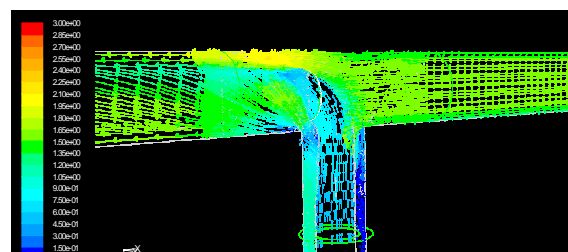

a) backflow – reduced elbow

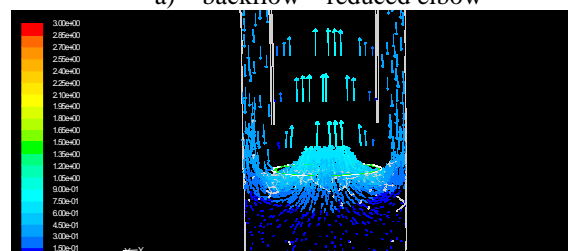

b) backflow – closed bottom

Figure 6. Flow conditions in the girder with backflow position of reduced elbow

In conditions of frontal inflow of water to the reduced elbow from the centrally placed pipe, the flow of water in the space of the vertical girder is realized in the following way, fig.5:

- The central part of the inserted pipe: the direction of flow is from the transverse horizontal pipe to the bottom end of the vertical joint (vertically down),
- Ring surface between the column and the centrally inserted pipe: the direction of flow is from the bottom part of the column to the transverse horizontal pipe (vertically upwards),

that is, the cooling of the wall in the girder is done by flowing water from the bottom to the top.

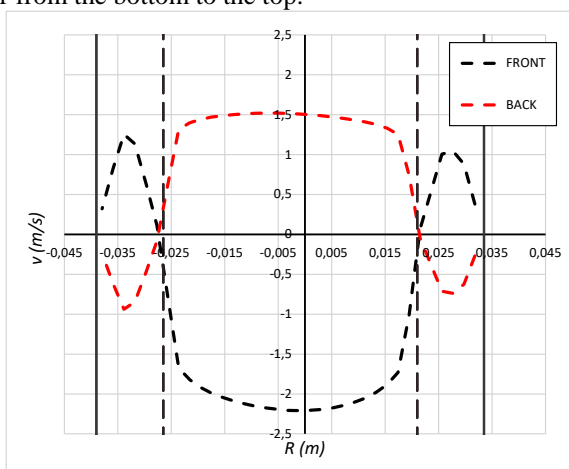

Figure 7. Comparison of velocity profile in the vertical girder depending of position of reduced elbow (closed bottom)

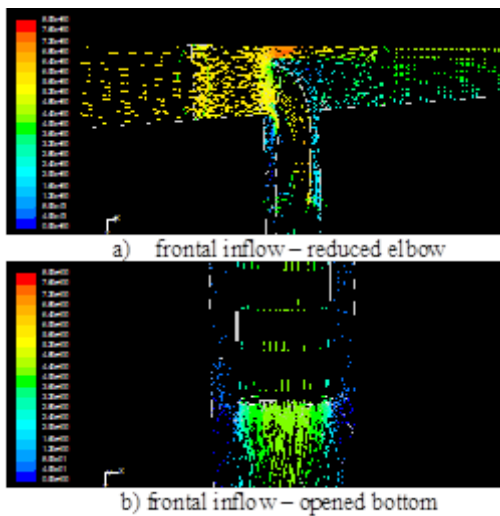

Figure 9. Flow conditions in the girder with frontal inflow position of reduced elbow - opened bottom

In conditions of back inflow of water to the reduced elbow from the centrally placed pipe, the flow of water in the space of the vertical girder is realized in the following way, fig.6:

- The central part of the inserted pipe: the direction of flow is from the bottom part of the column to the transverse horizontal pipe (vertically upwards),
- Ring surface between the column and the center tube: direction of flow from the transverse horizontal tube to the lower end of the vertical column (vertical down),

that is, the cooling of the wall of the girder is done by flowing water from top to bottom.

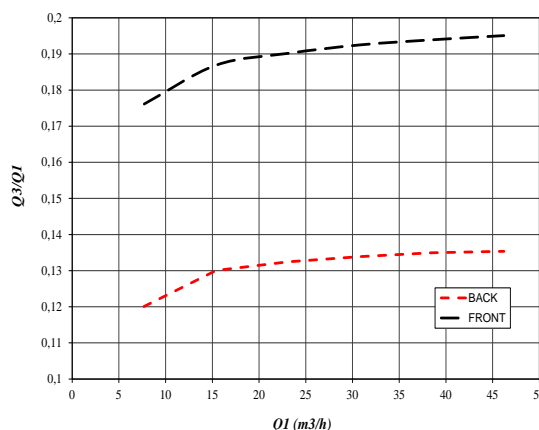

Figure 8. Relative discharge through the vertical girder depending of position of reduced elbow and main discharge into the system (closed system)

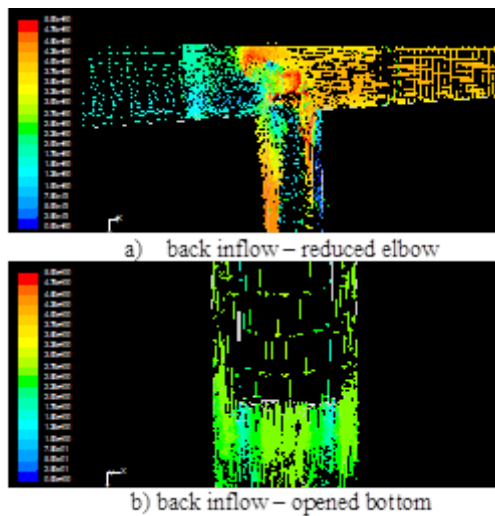

Figure 10. Flow conditions in the girder with back inflow position of reduced elbow - opened bottom

From the obtained fluid flow velocity profile for different modes of use in exploitation (different flow of supply water to the horizontal transverse system) an unambiguous direction of the fluid flow in the spaces of the vertical girder is obtained, fig.7.

The distribution of the diverted water flow with front and back placement of the central pipe in the cooling system of the vertical

girder is given in comparison in the following diagram, fig.8.

From the results obtained by numerical calculation and comparatively given on the diagram in conditions of front and back placement of the central pipe in the system, the following can be concluded:

- The performance with installation of front water intake for

redirection to the vertical girder provides higher inflow of cooling water by 6% compared to the system with back installation of intake,

- Mainly the difference of 6% for more efficient water diversion is for the whole range of possible exploitation (accurate) water to the transverse cooling system.

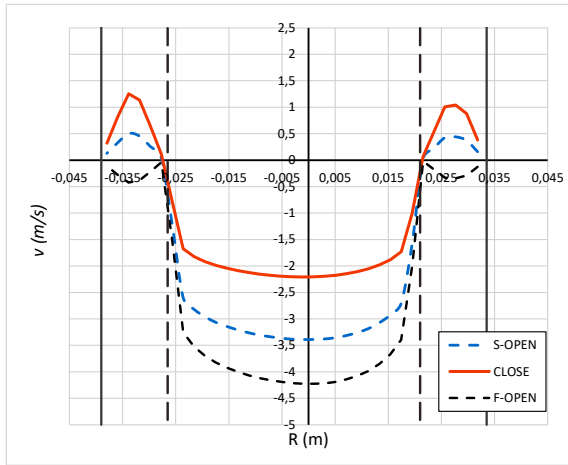

Figure 11. Comparison of velocity profile in the vertical girder with frontal position of reduced elbow (opened bottom)

Numerical simulation on the flow conditions in the girder is performed in conditions of water outflow discharge from the bottom part of the girder. The fluid flow field of water in the girder is given in the fig.9 in condition with frontal inlet and on fig.10 in condition with back inflow at position of reduced elbow.

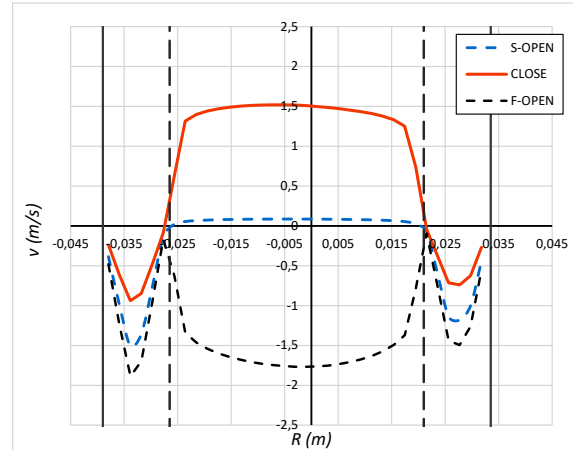
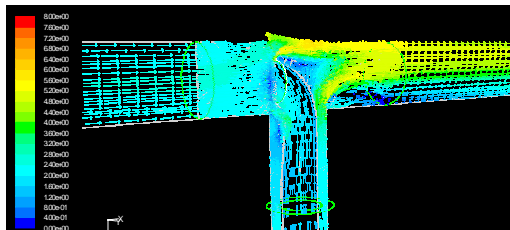
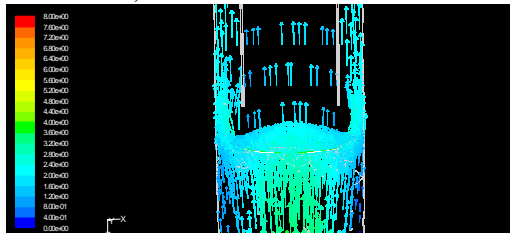

Figure 12. Comparison of velocity profile in the vertical girder with back position of reduced elbow (opened bottom)



a) frontal inflow – reduced elbow



b) frontal inflow – central inflow at bottom

Fig.13. Flow conditions in the girder with frontal inflow position of reduced elbow - central inflow at bottom

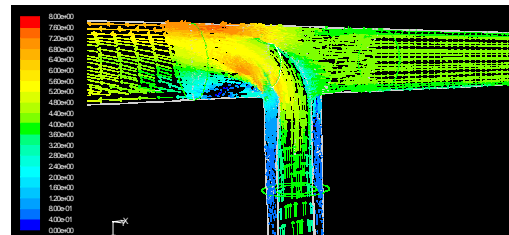

a) back inflow – reduced elbow

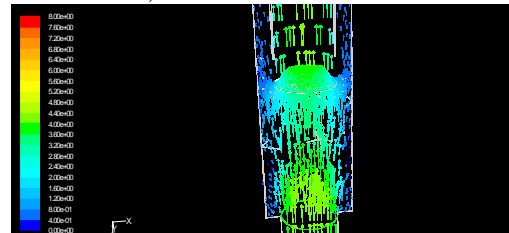

b) back inflow – central inflow at bottom

Fig.14. Flow conditions in the girder with back inflow position of reduced elbow - central inflow at bottom

Figure 13. Flow conditions in the girder with frontal inflow position of reduced elbow - central inflow at bottom

Figure 14. Flow conditions in the girder with back inflow position of reduced elbow - central inflow at bottom

B) Flow Condition with Opened Bottom

The established modes (front inflow) with an outflow from the bottom of the vertical girder show the following characteristics, fig 11:

- The direction and intensity of the velocity in the central space of the pipe inserted in the column, by providing a

outflow and by increasing the discharge outflow, changes both in intensity and in the direction, ie the system in the central part can be brought to a counter-current (from up to down) in relation to the operating flow regime.

- The direction and intensity of the flow in the annular space of the immersed pipe, by providing outflow from the bottom and by increasing the discharge outflow,

increases the intensity (speed) of the flow, while the direction remains unchanged.

The established modes (back inflow) with outflow from the bottom of the vertical girder show the following characteristics, fig.12:

- The direction and intensity of the velocity in the central space of the inserted pipe in the column, with increasing the flow rate becomes more dominant and the direction does not change.
- The direction and intensity of the flow in the annular space (inserted pipe-wall of a girder), by providing outflow from the bottom and by increasing the flow, reduces the intensity (speed) of the flow, and by increasing the discharge outflow changes both the intensity and the direction of water flow. In this part of the flow space, the provided outflow from the lower side, is negatively reflected in the operating conditions of the cooling system of the vertical girder, i.e. the system can be brought in a state so that in the ring space there is no velocity, which could be achieved a state of no cooling on the wall of the girder.

C) Flow Condition with Central Inflow at Bottom

Numerical simulation on the flow conditions in the girder is performed in conditions of water central inflow discharge from the bottom part of the girder. The fluid flow field of water in the girder is given in the fig.13 in condition with frontal inlet and on fig.14 in condition with back inflow at position of reduced elbow.

The established modes (front inflow) with inflow from the bottom of the vertical girder show the following features, fig15:

- The direction and intensity of the fluid current in the central space of the pipe inserted in the column, by providing a supply and by increasing the flow of the supply, changes both in intensity and direction, i.e. the system in the central part can be brought to a counter-flow current (from downwards) in relation to the operating current regime.
- The direction and intensity of the flow in the annular space of the column, by providing inflow from the bottom and by increasing the inflow flow, increases the intensity (speed) of the flow, while the direction remains unchanged.
- It should be noted that there is a limit to which the flow can be increased where the effect of increased intensity of velocity in the annular space can be achieved, followed by saturation (insignificant change in intensity) and dominantly increases the flow in the central space on the girder.

The established modes (back inflow) with inflow from the bottom of the vertical bar show the following features, fig 16:

- The direction and intensity of the flow in the central space of the pipe inserted in the column, with increasing the flow rate of the flow becomes more dominant and the direction does not change.
- The direction and intensity of the flow in the annular space (inserted pipe-wall of a girder), by providing inflow

from the bottom and by increasing the outflow flow, reduces the intensity (velocity) of the flow, and by increasing the inflow flow rate are changes both the intensity and the direction of water flow. In this part of the flow space, the provided inlet from the lower side, is negatively reflected on the operating conditions of the cooling system of the vertical pole, i.e. the system can be brought to a state such that in the ring space there is no fluid current, which means to achieve a state of no cooling on the wall of the girder.

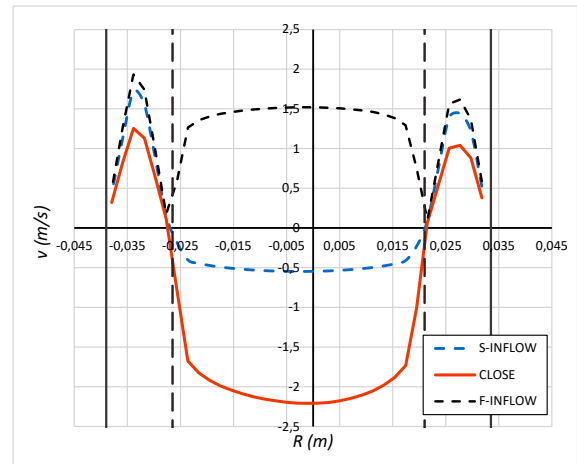

Figure 15. Comparison of velocity profile in the vertical girder with frontal position of reduced elbow (central inflow at bottom)

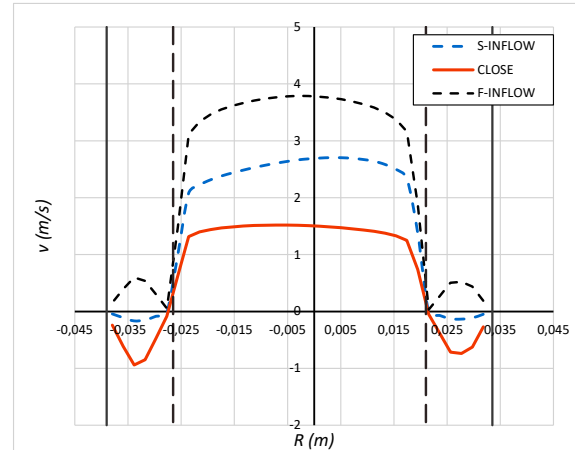

Figure 16. Comparison of velocity profile in the vertical girder with back position of reduced elbow (central inflow at bottom)

IV PROPOSED RECONSTRUCTION

The concept of intensifying the flow in the ring zone is realized by introducing an external amount of fresh water in the space above the outlet surface (lower section) of the inserted pipe. External water intake should provide:

- Non-disturbance of the exploitation mode of water flow in the space of the vertical girder, i.e. not to change the direction of water flow in the individual zones which is established during the exploitation conditions of the system operation,

- Intensification of the flow velocities in the zone of the annular space from the vertical girder,
- More symmetrical distribution of the brought amount of water at the height of the vertical girder, ie by introducing the external water not to create zones of uneven obstruction of the wall of the girder which would create conditions for uneven cooling,
- The mixing of the brought water and the water from the basic flow in the space of the vertical column to be done continuously along the height of the vertical column in order not to cause inequality and zones of more intense cooling.

The concept of upgrading the cooling system of the vertical columns with a system for continuous rinsing-cleaning of the zones of the vertical column is applicable in conditions of positioning the central pipe with front water inflow.

The cooling system upgrade at the bottom of the vertical column is given on fig.17. The system upgrade consists of:

- The installation of two diametrically opposite pipes,
- The installation of the pipes to be performed so as to provide tangential flow of the jet in relation to the axis of the column,

- The pipes are placed in a vertical plane at an angle of 45° , so that the angle of velocity is directed inwards, towards the upper part of the girder,
- The lower edge of the inlet is made above the outlet edge of the central pipe, so that the outlet jet of the inlet pipe starts in the zone above the outlet of the central pipe.

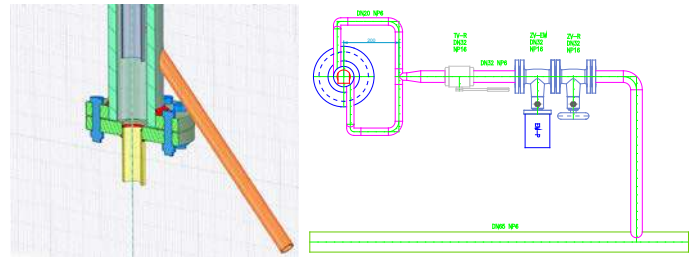

Fig.17. Tangential supply of water at bottom side of the girder

Numerical analysis on the flow conditions in the girder is performed in conditions of water outflow discharge from the bottom part of the girder. The fluid flow field in the girder is given in the fig.18 in condition with frontal inlet and different intensity of tangential inflow discharge.

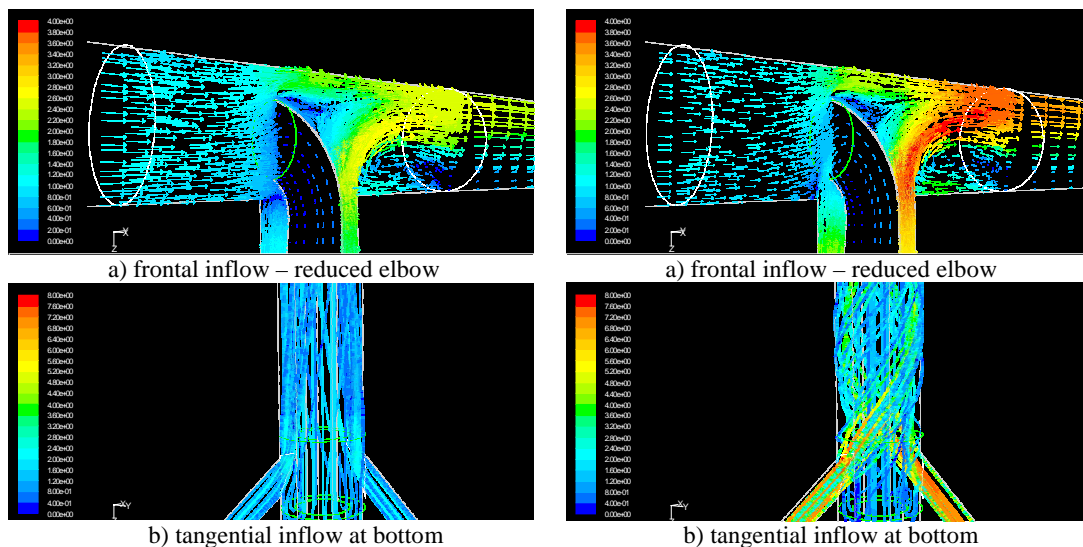

Figure 18. Flow conditions in the girder with frontal inflow position of reduced elbow - tangential inflow at bottom

Based on the numerically obtained results, the following can be concluded, fig.19:

- The vector field shows that the tangentially brought jet of fresh water sticks to the wall of the column, and at the same time does not disturb the flow from the central pipe.
- The arrangement of the flow currents in the space of the ring zone from the vertical pipe to the column shows that the flow in the space vertically upwards is twisted, ie the inserted tangential jets provide eddy current and thus mixing the water returning from the central pipe and the water coming through tangential inflow.
- The velocity field that is created in the space of the vertical pipe depends on the flow that is brought from the tangential connections and with the increase of the water

supply, the dominance of the eddy current increases.

- From the results for the distribution of the velocities on the reference plane it is obtained that the direction of flow which is obtained in the space of the vertical girder during exploiting conditions of use is not disturbed by introducing the tangential water flow in the system.
- According to the velocity profiles it can be concluded that the induced water flow significantly affects the increase of the flow velocity in the annular space of the vertical column, while the flow (velocity) in the central pipe decreases insignificantly.
- The placement of the tangential feed in the zone above the outlet section of the central pipe provides more favorable conditions of flow in the space of the vertical girder.

The distribution of the flow to the cooling system of the vertical girder in conditions of frontal inflow of water to the system is defined. The diagram for flow distribution (fig.20) presents the relative distribution of diverted water to the vertical column cooling system depending on the flow rate to the column. Namely, it is denoted by the flow of water for cooling the vertical column (redirected flow of water), and by the corresponding flow to the column system. In conditions of different intensity of induced flow from the tangential system (upgraded system), the percentage capture (diversion) to the central pipe from the vertical column of the supply water also changes.

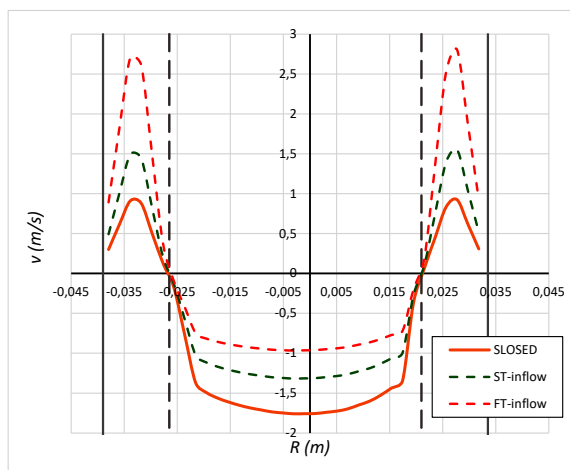

Figure 19. Comparison of velocity profile in the vertical girder with frontal inflow and tangential water supply at bottom

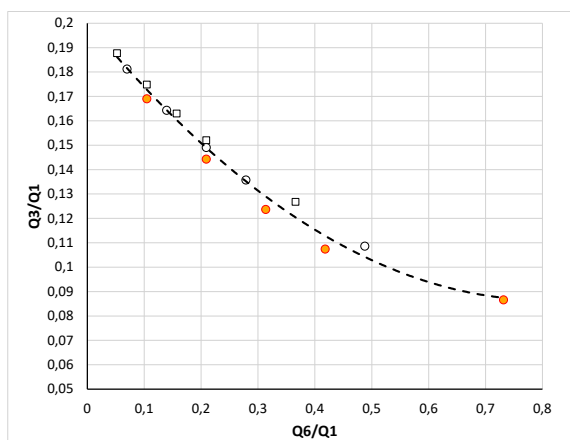

Figure 20. Relative discharge through the vertical girder depending of different tangential discharge at bottom

From the obtained calculation means it is concluded, fig.20:

- The amount of diverted water from the supply water to the head water intake depends on both the supply flow and the induced flow from the overheated system.
- With increasing the induced flow from the upgraded system the percentage of occupied (redirected) water through the central pipe decreases.
- A mode is achieved (dashed red line) that after a certain induced flow, the amount of water that is transferred through the central pipe increases. The analysis of the

flow achieved under these numerical exploitation conditions shows that part of the drained water, the vertical column is directed again to the inflow of the central pipe, ie there is a re-circulation in the space of the vertical girder.

V CONCLUSION

Based on the project documentation for the cooling system of the vertical columns, a numerical analysis was performed on the functionality and efficiency of the existing system using CFD technology, and based on the obtained results, the hydrodynamic model of the system was developed / defined provide for vertical girder both in operating conditions and in modes that can be provided during operation.

Based on the conceptual solution, spatial possibilities and conditions, a solution for upgrading the system is analyzed which will provide continuous flushing during the operation of the system by providing external inflow of fresh water into the system.

The upgrade of the system does not require additional hydraulic equipment (pumps, etc.) but is set so that the existing operating conditions are incorporated in the concept of the solution. Namely, the upgrade ensures that the existing energy potential of the water used for the sectional horizontal transverse cooling pipelines is also used for flushing the system itself. The flushing is done continuously during the operation of the system, using the existing design solutions of the system, ie an upgrade is proposed which will provide in a given time interval the introduction of fresh external water through the vertical girder in the cooling system.

Setting up the upgrade means:

- to make a unification of the position of the inner pipe in the entire cooling system, with a proposal to provide front water supply due to the following operating conditions provided by this position:
 - Larger amount of cooling water diversion to the vertical column,
 - Higher heat transfer capacity to remove heat from the system.
- to introduce an additional system on the underside of the vertical girder which will occasionally be activated and will ensure fluid flow of the annular current space of the pole during the operation of the system, thus avoiding the conditions for deposition of potential debris in the water.
- the proposed solution for upgrading the system by introducing an external inflow of cooling water from the lower side of the vertical column with tangential water intake, provides directed cooling in the annular zone of the column and more intensive cooling of the wall of the column.
- the proposed upgrade of the cooling system of the vertical columns with a system for purification-rinsing of the system during operation has several effects, which are:
 - Preconditions are provided so that there is no accumulation and clogging of the flow space of the vertical poles due to red impurities in the cooling water, by providing zonal intensification of the flow

- If necessary, the possibility is provided for more intensive cooling of some of the stumps by bringing fresh water
- Increases the flexibility and reliability of the operation of the cooling system because there is a possibility for external intervention by bringing fresh water, additionally for local intervention in the system
- Timely detection of malfunctions in the operation of parts in the cooling system and taking appropriate maintenance measures
- The existing concept of exploitation and maintenance of the system is not disturbed, but a solution for upgrading is proposed which improves the exploitation use of the system.

LITERATURA/ REFERENCES

- [1] Stojkovski, F., Kostikj, Z., Stojkovski, V. Implementation of CFD technology for upgrading a measuring parallel pipe line in thermal systems, *Energetika, ekonomija, ekologija*, Vol. XX, No. 1-2, pp. 115-121, 2018.
- [2] Levski, A., Stojkovski, V. Numerical Research of the Swirl Velocity on the Origin of Cavitation, in Proc. *18th Symposium on Thermal Science and Engineering of Serbia SIMTERM-2017*, Sokobanja, Serbia, 17-20, October 2017.
- [3] Stojkovski, F., Stojkovski, V., Noshpal, A. CFD Analyses to the Impact of the Pipe Connectors on the Flow Distribution in Parallel Short Pipelines, in Proc. *18th Symposium on Thermal Science and Engineering of Serbia SIMTERM-2017*, Sokobanja, Serbia, 17-20, October 2017.
- [4] Iliev V., Popovski P., Markov Z. Water hammer analysis using characteristics method and numerical simulation, *Mechanical Engineering-Scientific Journal*, Vol. 31, No. 1-2, pp. 53-62, 2013.

AUTORI/AUTHORS

Valentino Stojkovski, PhD - Professor, "Ss. Cyril and Methodius" University, Faculty of Mechanical Engineering Skopje, Republic of North Macedonia, valentino.stojkovski@mf.edu.mk

Viktor Iliev, PhD - Associate Professor, "Ss. Cyril and Methodius" University, Faculty of Mechanical Engineering Skopje, Republic of North Macedonia, viktor.iliev@mf.edu.mk

Filip Stojkovski, MSc, "Ss. Cyril and Methodius" University, Faculty of Mechanical Engineering - Skopje, Republic of North Macedonia, filip_stojkovski@outlook.mk