

A Wideband and Efficient Patch Antenna with Two Different Feeding Mechanisms for Ku/K Bands Applications

Gulzar Ahmad^{1a}, Muhammad Inayatullah Babar², Siddique Ali^{1b}, Faheem Ali^{1c}

RECEIVED ON 12.12.2018, ACCEPTED ON 03.05.2019

ABSTRACT

Low BW (Bandwidth) is a major limitation of microstrip antennas. A patch antenna having a large BW for Ku band applications is demonstrated in this manuscript. The skills of Defected Ground Structure (DGS) and defected driven patch were engaged to widen its BW. Four slices have also been confiscated from the ground for upgrading various characteristics. It is established on the basis of this study that it can be employed in spectrum defining Ku and K bands. It puts forward an impedance BW of 8GHz, which is appropriate for numerous applications. The ground/substrate of the structure under consideration is 22×10^{-3} m long and 10×10^{-3} m wide and these specifications imply that the volume of this design is very small. The entire structure's utmost thickness is 1.67×10^{-3} m. It can be easily installed in relevant handy electronic devices. Investigations and analysis in this case are made with computer software known as Computer Simulation Technology. The simulated design exhibits a very good gain and efficiency. Deviation in the gain of the simulated design was from 4.4 7.3dBi and it guaranteed the highest efficiency of 98.6%. Some minor changes in the antenna resulted in expansion in the BW from 8GHz to 14GHz. The return loss which was recorded at frequency of 18.15GHz went to 48.97dB and the mentioned changes assured the uppermost efficiency of 83.1%. The fabricated antenna achieved a bandwidth of 28GHz which is far better than the simulated bandwidth.

Key Words: Low Profile, Return Loss, Defected Ground Structure, Ku-Band, K-Band, Parasitic Patch.

1. INTRODUCTION

A wideband antenna is very important part in the current epoch of wireless communication systems. Recently, researchers have developed a great interest in designing large BW antennas in Ku and K bands [1-6]. These higher frequencies antennas serve different areas of wireless communications like satellite used for mobile services, satellite used for broadcast services and fixed satellite communication links [7]. A microstrip patch antenna in its simplest form is exposed in Fig. 1.

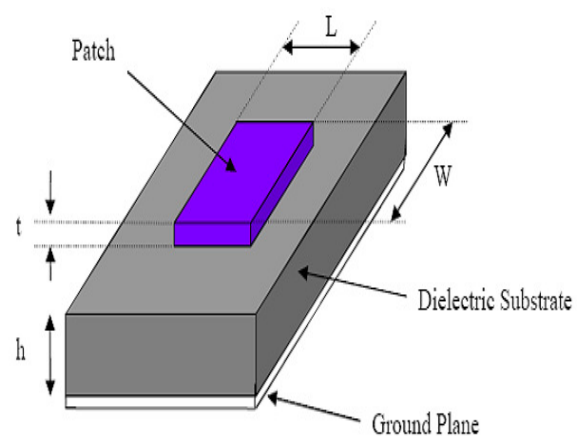

FIG. 1. SIMPLEST STRUCTURE

¹ Department of Electrical Engineering, University of Engineering and Technology, Peshawar, Pakistan. Email: ^agulzar@uetpeshawar.edu.pk (Corresponding Author), ^bsiddique.ali@gmail.com, ^cfaheem@uetpeshawar.edu.pk

² University of Engineering and Technology, Taxila, Pakistan. Email: mohammad.babar@gmail.com

A number of methods have been devised so far to get the large BW. Some researchers have worked on thick substrate but it makes the antenna bulky. Passive elements which are known as parasitic patches have been employed for the purpose under consideration. Electromagnetic Band Gap Structures and different feeding mechanisms have improved the BW as well and all these methods have been conferred in [8-11]. A lot of work has been done on the DGS in which deliberate defects or slots are created purposely in the ground for the improvement of the BW [12-14]. A new patch antenna [15] has a simple undersized structure and it leads to a fine BW. The antenna simulated bandwidth is 1.97 GHz which varies from 10.94GHz to 12.91GHz, while its measured BW is 2.75GHz. It can be concluded on the basis of the measured and tested results that the fabricated structure confirmed better performance in comparison with the simulated one. The gain in this research paper has been declared as 4.91dBi. The antenna for Ku band satellite communications with dual-band operation is argued in [16]. The values of two resonating frequencies from K band were reported and it was argued that the structure was matched properly for its efficient operation. The BW of 854 and 1140 MHz were accomplished. In comparison with other radiating antennas in [17-19], the proposed antenna had a broad BW. A patch antenna on Teflon substrate was examined in [20] and BW of 4.1GHz was established during this study. Its coefficient of reflection was recorded as 26.55 decibels. Another antenna with a size of 15x15 mm [21] has BW of 0.95 GHz for Ku-band applications. The simulation results of [22] have established 2.1 GHz BW. The microstrip antenna has got attraction due to its light weight, it can be fabricated easily and it is very cost effective. It has so many applications in wireless communication systems [23-24]. Many antenna configurations are projected in literature to enhance BW requirements. An elliptical structure was optimized in [25] which guaranteed its employment in the mentioned spectrum. This research implies that variation in patch structure improves different characteristics. Air is a dielectric material as well but solid dielectric objects are implemented as substrate as it enhances the mechanical strength of the structure. It was derived in [26] that for designing an efficient structure, the designer needs to pick the best dielectric material with appropriate thickness as different

characteristics are dependent on it. It was concluded in [27] that parasitic patches should be put into practice in comparison with increasing the substrate's thickness for the extension of the operational BW as this is the only technique that does not debase the remaining performance parameters. Different novel mechanisms were explored in [28] for the optimum design having reasonably high gain and large working electromagnetic spectrum.

For the comparison of the BW of the proposed structure a paper in [29] was reviewed. This circular Patch dual antenna provided the first impedance BW of 309 and the second BW of 501MHz. The BW and efficiency of the proposed design is far better than both of the mentioned BWs.

2. DESIGN OF THE ANTENNA

The Preperm L450 was selected as a substrate material as it is very efficient. The relative permittivity of the selected material is 4.5, loss tangent is 0.0005 and its height is represented by h. The computer software which was engaged for simulating the proposed antenna is Computer Simulation Technology [30]. Computer Simulation Technology Microwave Studio is a powerful three dimensional tool which enables fast and accurate analysis of high frequency components like antenna, filters and couplers. The specifications for the design are given in Table 1. The copper material was used in the ground and all patches of this design.

TABLE 1. SPECIFICATIONS OF ANTENNA	
Description of the Dimensions	Values
Area of the Substrate/Ground	22x10mm ²
Height (h) of the Dielectric Material of the Substrate	1.6mm
Copper Material's Thickness	0.035mm
Specification of Slot no 1	2.6x7mm ²
Specification of Slot no 2	1x1.5mm ²
Specification of Slot no 3	1x8mm ²
Specification of Slot no 4	1x5mm ²
Specification of the left side parasitic patch	2.5x6.5mm ²
Specification of the right side parasitic patch	2.8x3mm ²

Proper choice of feeding technique during the antenna design plays a crucial role for upgrading its performance. Two different feeding mechanisms have been engaged in this design as the selection of an appropriate feeding mechanism is very important for upgrading the antenna's performance. A very familiar and easy method used to energize a microstrip patch antenna is the coaxial cable feed mechanism. The major benefit of this technique is to apply it to appropriate position of feed patch for excellent impedance matching. This technique has been applied to the design of Fig. 2. Three different procedures were engaged to get better impedance BW of the patch antenna: Two Parasitic elements were placed on top of the substrate in vicinity of the feed patch and these elements cause the expansion in the BW characteristic of the antenna. The defected ground structure has been made in the ground plane for further improvement of its BW and efficiency. The design has been shown in the pictorial view of Fig. 2.

There are two parasitic patches and one Feed Patch. Four defects were generated in the ground, which are characterized by 1, 2, 3 and 4 in the pictorial view. The coaxial feed was constructed at a point which was

9.4mm away from the right edge and 2.6 mm away from the bottom edge. The specifications of the Substrate/Ground, patches and all the four ground slots are illustrated in Table 1. The pictorial view of the antenna along with its specifications is displayed in Fig. 3. The left side parasitic element was created 1.75mm above the bottom edge of the Substrate. The Y shaped feed patch was made at the center of the substrate. The size of the right side parasitic patch was $2.8 \times 3 \text{ mm}^2$. This element was created just by introducing an air gap of 0.3mm in the right limb of the Y shaped driven patch.

The view in Fig. 4. illustrates specifications of all the four slots. Separation between Slot-1 and left edge of the ground comes out to be 2.5mm and it is situated at vertical distance of 1.5mm with respect to the bottom edge of the ground. Distance between Slot-2 and the left edge of the ground plane was 6mm. Slot-3 was produced at a distance of 11mm from the left edge and 1mm above the bottom edge. Slot-4 is located at a horizontal distance of 3mm with respect to the right edge of the ground plane and 4mm above the ground edge. All these specification are mentioned in the dimensional view.

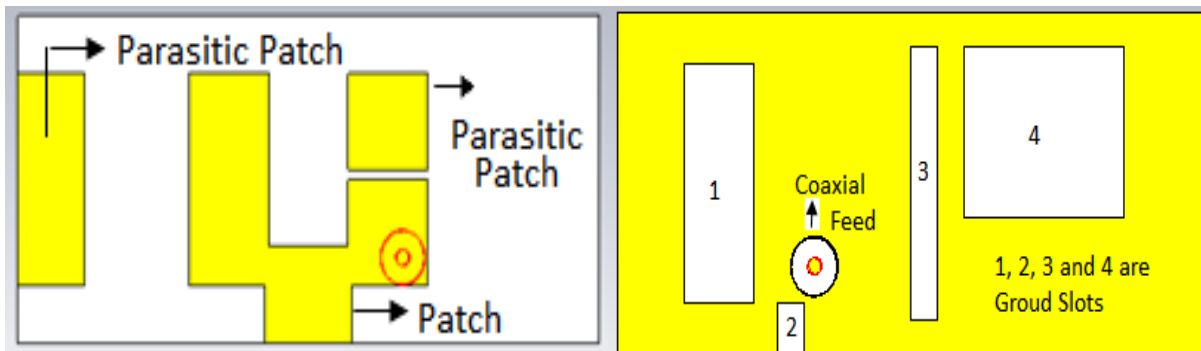

FIG. 2. PICTORIAL VIEWS OF THE PATCH AND GROUND

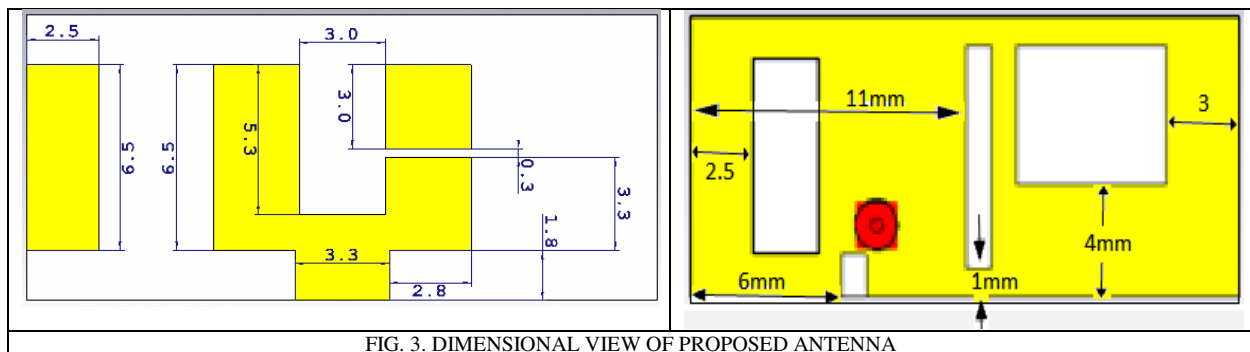

FIG. 3. DIMENSIONAL VIEW OF PROPOSED ANTENNA

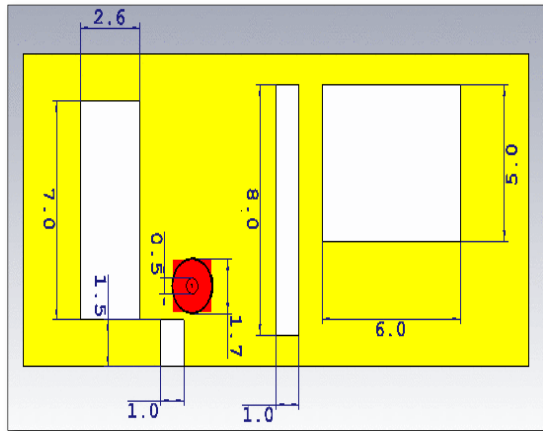

FIG. 4. GROUND VIEW

3. DISCUSSION ON THE RESULTS OF THE FIRST STRUCTURE

Key characteristics of the simulated antenna like BW, Voltage Standing Wave Ratio (VSWR), RL (Return Loss) and Efficiencies were investigated in this study and the outcomes are conferred in the forthcoming sections.

3.1 Bandwidth and Coefficient of Reflection

Coefficient of reflection portrays strength of the output signal of the antenna and basically it is the negative value of RL. When antenna is mismatched the total power is not sent to the antenna and some power returns from the antenna which is labeled as the 'RL'. A mismatched antenna reflects more energy in the backward direction towards the transmitter and this reflected energy is not available for transmission. The reflected signal distorts the signal travelling towards antenna which reduces the efficiency and thus the coverage area decreases as well.

The center frequency took place at 21.46GHz in the K-band and the corresponding value of the return loss was observed as 45.75dB. In comparison with different research the aforementioned value points toward the best matching especially at the center resonant frequency. The impedance BW which is measured below -10dB in Fig.5 came out to be 8GHz. The attained BW is so large that it addresses the issue of narrowness which was considered as a main constraint of patch antennas. As this large BW is

located in the Ku and K bands, hence the antenna can be employed for the mentioned bands applications.

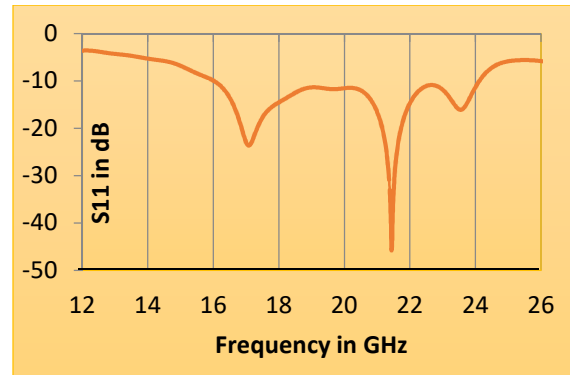

FIG. 5. RETURN LOSS VERSUS FREQUENCY

3.2 Voltage Standing Wave Ratio

Reflected signal from an antenna due to mismatch interferes with the input signal which results into standing wave. Significance of standing wave and consideration of Standing Wave Ratio (SWR) are expressed as follow; If standing wave is pure then no energy will be transferred to antenna and consequently no energy will be transferred to the atmospheric information channel. So elimination of reflected wave is very essential. For efficient operation of antenna maximum energy should be transferred to it with the help of matching mechanism. Once antenna is matched properly to its feed line then it will transfer the maximum energy to the wireless information channel.

Ideal value of the mentioned ratio is 1. SWR graph of the simulated design justifies its satisfactory performance in the whole BW as shown in Fig. 6. The minimum value of SWR which was recorded during the simulation was 1.01 and the corresponding value of the resonant frequency from the K-band was 21.43GHz.

3.3 Radiation Efficiency

The power radiated by an antenna is always less than its input power due to conduction and dielectric losses. The efficiency gives the portion of the input energy which is transferred over to the wireless channel. So the ratio of the power which is transferred over to the

information channel to the power at input terminals of an antenna is termed as radiation efficiency.

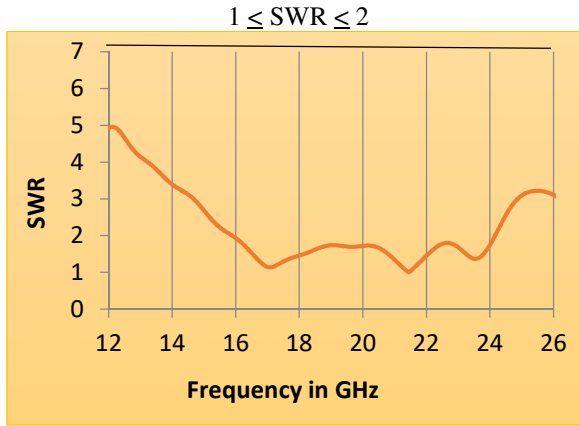

FIG. 6. VSWR OF THE ANTENNA

In case of patch antenna one needs to select the appropriate material of the substrate to improve the radiation efficiency. The product of the mismatch loss of an antenna and its radiation efficiency defines total efficiency which is always less than radiation efficiency. Fig.7 displays the radiation efficiency of our simulated structure. Fig. 7 discloses the fact that this antenna is an efficient antenna as its efficiency does not drop below 90% in the whole spectrum. 98.6% efficiency will be given by this antenna at 16.4GHz. The high efficiency in Fig. 7 defends the selection of Preperm L450 for the substrate of the antenna.

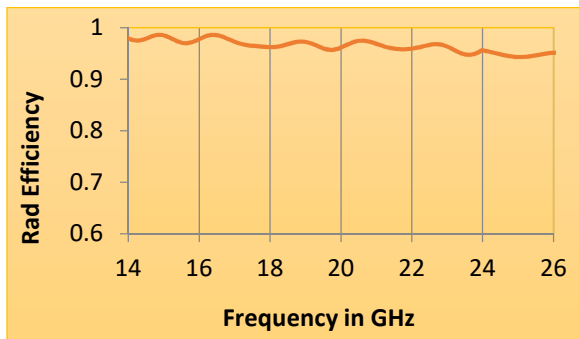

FIG. 7. RADIATION EFFICIENCY

Similarly, the total efficiency is exhibited in Fig. 8. A minor difference can be observed between the radiation and total efficiency which justifies a good match between the antenna and feed line. The total efficiency does go down beyond 88% and its maximum value is 96.77%.

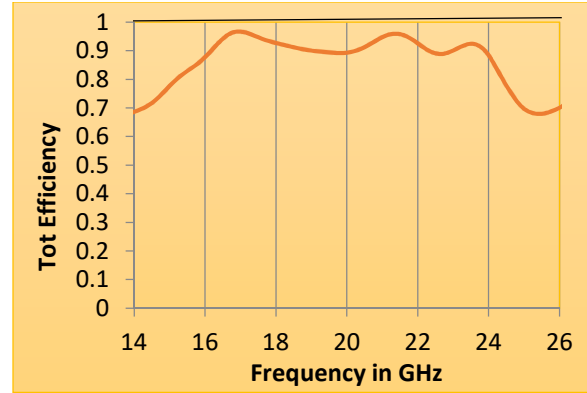

FIG. 8. TOTAL EFFICIENCY

3.4 Directivity of the Simulated Design

The directivity of this directional antenna is exhibited in Fig.9. The antenna demonstrates different directivities at different frequencies. The plot exhibits variation in the directivity of the simulated design from 4.6-7.6dB.

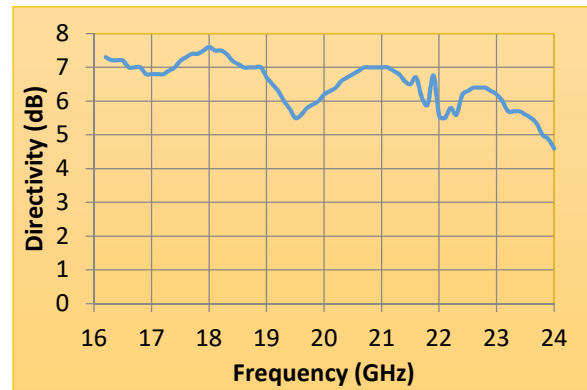

FIG. 9. DIRECTIVITY OF THE SIMULATED STRUCTURE

Various means have been investigated by the researchers to boost the directivity and these mechanisms are found in the relevant literature. So fortification of this characteristic is recommended as future work.

The product of directivity and efficiency defines gain of the antenna. The plot in Fig. 10 exhibits variation in the gain of the simulated design from 4.4-7.3dB. No considerable change between the gain and directivity of our simulated structure can be observed as plot for the gain almost follows the same pattern. This argument also concludes that the simulated antenna is an efficient antenna with a large BW.

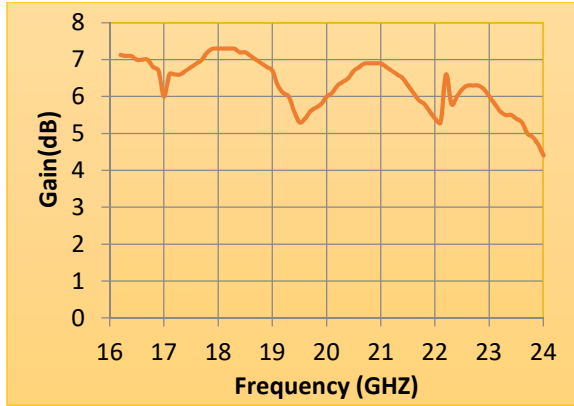

FIG. 10. GAIN OF THE SIMULATED STRUCTURE

4. CHANGES IN THE STRUCTURE

Some changes were incorporated in the above structure which resulted in the expansion of the BW and the changes were highlighted in Fig. 11. Another feeding mechanism was employed here which is named as inset fed line.

These changes can be noted down from the comparison between Tables 1-2. The comparison discloses that the specifications of Slots 2-4 and the areas of the two parasitic elements were customized and are elaborated in Table 2.

No.	Description of the Dimensions	Values
1.	Area of the Substrate/ Ground	22×10mm ²
2.	Height (h) of the Dielectric Material of the Substrate	1.6mm
3.	Copper Material's Thickness	0.035mm
4.	Specification of Slot no 1	2.6×7mm ²
5.	Specification of Slot no 2	1×2mm ²
6.	Specification of Slot no 3	1×7mm ²
7.	Specification of Slot no 4	6×5mm ²
8.	Specification of the left side parasitic patch	2×6.5mm ²
9.	Specification of the right side parasitic patch	2.9×2.05mm ²

Separation between Slot-1 and left edge of the ground comes out to be 2.5mm and this slot is positioned at a distance of 1.5mm from the lower edge. Distance between Slot-2 and the left edge of the ground plane

was 6mm. Slot-3 was produced at a distance of 11mm from the left edge and 1.5mm above the lower edge. Slot-4 is located at a horizontal distance of 13mm with respect to the left edge of the ground plane and a vertical distance of 4mm with respect to the lower edge. The remaining specifications are mentioned in the dimensional views.

5. DISCUSSION ON THE RESULTS OF SECOND STRUCTURE

The above mentioned changes expanded the bandwidth from 8GHz to 14GHz and a view of this augmented bandwidth can be observed in Fig. 12.

SWR was brought down to 1.007 and this ratio occurred at 18.15GHz as displayed in Fig. 13. And the ratio at the center frequency is far better than the papers reviewed in the literature of this manuscript. The total efficiency fluctuates from 0.50-0.84 as confirmed in Fig. 14.

Comparison of some of the reviewed work in the literature survey of this paper with the proposed work has been elaborated in Table 3. The reflection coefficient was recorded at the center frequency. The values of bandwidth, VSWR and reflection coefficient of the antennas obtained in [15-16,20-22,29, 31-33] are less and all these parameters have been improved in this work.

6. RESULTS OF THE FABRICATED DESIGN

The design shown in Fig. 11 was fabricated using the parameters given in this manuscript. Two different views of this fabricated design are displayed in Fig.15. The left view shows the main patch along with the two parasitic patches and the right view shows the ground which has all the four slots. The conducting material used in all the three patches and the ground plane are made of copper.

This antenna was tested in the laboratory with the help of Vector Network Analyzer which has the measuring capability from 1-40GHz. The measured results are discussed in the forthcoming paragraphs. The reflection coefficient of this fabricated antenna was

sketched with respect to frequency as displayed in Fig.16. The working bandwidth starts from 12.5GHz and ends at 40.5GHz thus giving a huge bandwidth of 28GHz in the Ku, K and Ka bands. The bandwidth of the simulated antenna was 14GHz, bandwidth. The reflection coefficient of the fabricated structure is -39.4dB, which was observed at the center frequency of

33.8GHz. Thus the center frequency is 33.8GHz. Comparison of the results of the simulated antenna with the results of the fabricated antenna has been elaborated in Table 4. The reflection coefficient and VSWR were recorded at the center frequencies.

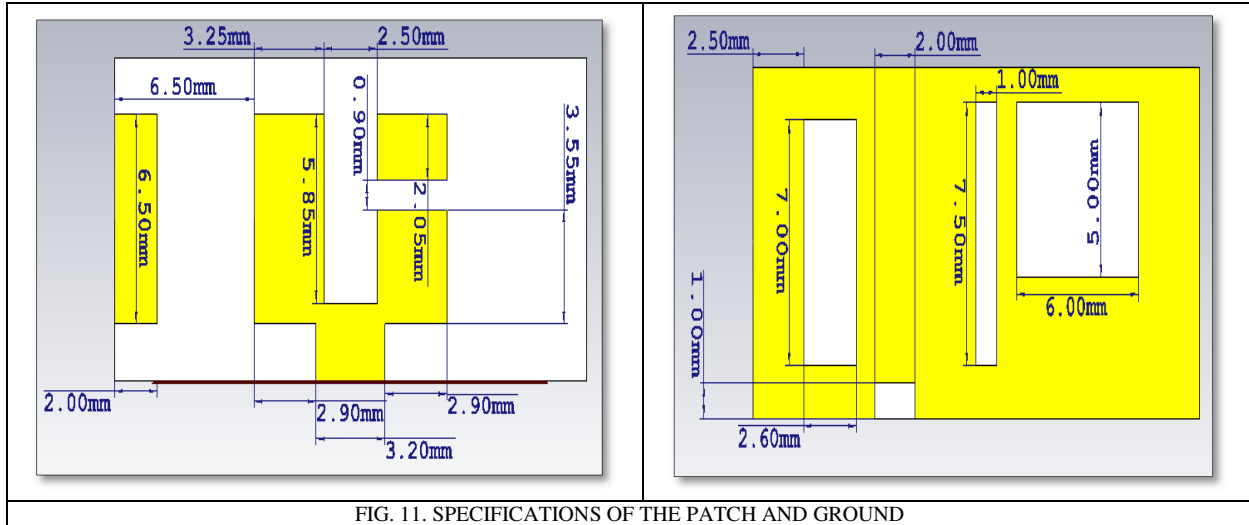

FIG. 11. SPECIFICATIONS OF THE PATCH AND GROUND

TABLE 3. COMPARISON OF EXISTING ANTENNA MODELS WITH THE PROPOSED DESIGN

References	Bandwidth Obtained	Efficiency	VSWR	Reflection Coefficient	Remarks
[15]	2.5GHZ	82-86%	-	-22dB	Both the bandwidth and efficiency are less than the proposed one
[16]	854 and 1140 MHz	Not Mentioned	Less than 2	-42.18dB & -38.39 dB	Both the bandwidths are negligible as compared to the proposed one.
[20]	4.15GHz	98.99% radiation	1.09	-26.55dB	Its bandwidth is less than the proposed design. Its radiation efficiency is at par with the proposed design.
[21]	0.96GHz	Not Mentioned	Less than 2	-23dB	Its bandwidth is very less as compared to the proposed design.
[22]	2.1GHz	Not Mentioned	-	-26dB	Its bandwidth is less than the proposed design
[29]	309& 501MHz	Not Mentioned	Less than 2	-22.5dB	Its bandwidth is less than the proposed design
[31]	400MHz	97%	1.22	-21.79dB	Its bandwidth and its maximum radiation efficiency are less than the proposed Design
[32]	1.24GHz	84.8%	1.1	-25dB	Its bandwidth and its reflection coefficient are less than the proposed Design
[33]	5.51GHz	98.85%	1.1	-26.01	Its bandwidth and its reflection coefficient are less than the proposed Design
This Work	14GHz	98.6%	1.007	-49dB	Its bandwidth, efficiency and VSWR are far better than the results mentioned in the above papers.

Simulated Antenna			Fabricated Antenna		
BW	RL	VSWR	BW	RL	VSWR
14GHz	-49dB	1.007	28GHz	-39.4dB	1.02

BW = Bandwidth, RL = Reflection Coefficient

The VSWR is shown in Fig.17, which confirms that the ratio is well below 2. The minimum value of this ratio is 1.02 which corresponds to the center frequency of 33.8GHz

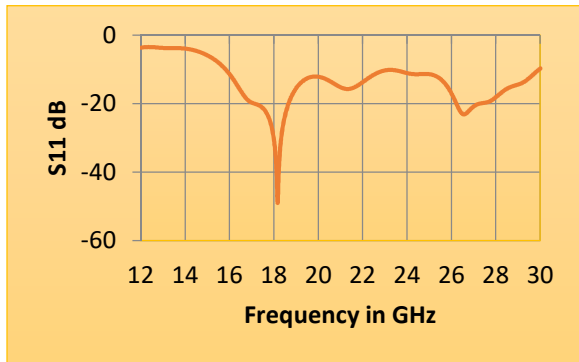

FIG. 12. S₁₁ VERSUS FREQUENCY

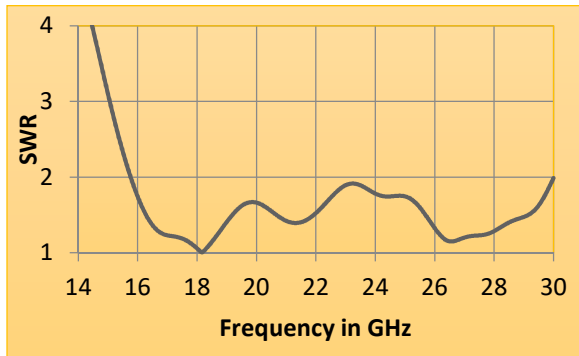

FIG. 13. SWR VERSUS FREQUENCY

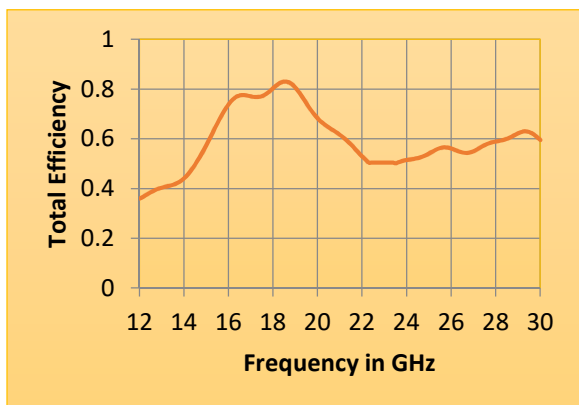

FIG. 14 TOTAL EFFICIENCY VERSUS FREQUENCY

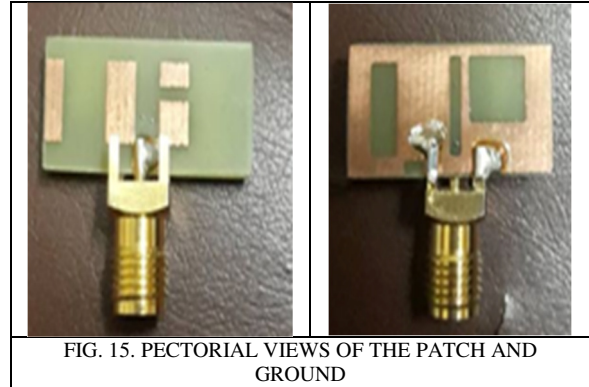

FIG. 15. PECTORIAL VIEWS OF THE PATCH AND GROUND

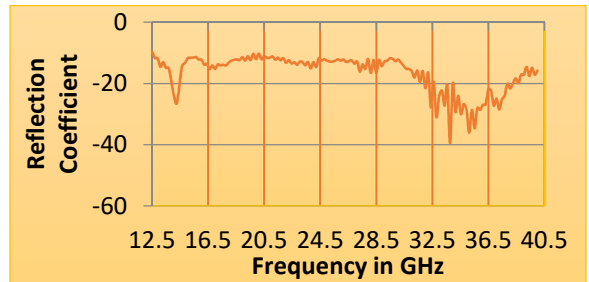

FIG 16: REFLECTION COEFFICIENT VERSUS FREQUENCY OF THE FABRICATED ANTENNA

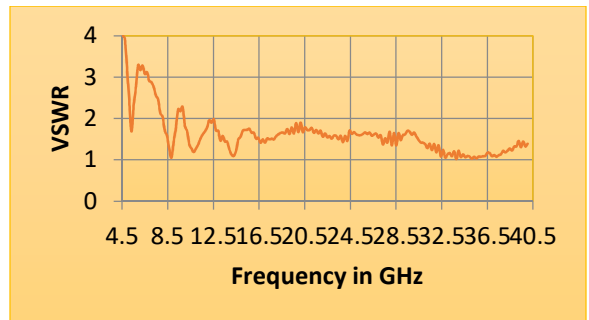

FIG. 17. VSWR VERSUS FREQUENCY OF THE FABRICATED ANTENNA

7. CONCLUSION

Simulated exploration of an efficient and wideband patch antenna with Preperm L450 Substrate was made in this paper. The minimized structure can be successfully employed in the applicable area of Ku and K bands. The analysis concludes that the structure provides high efficiency and a large BW in the specified electromagnetic spectrum. The matching of our structure with 50Ω coaxial supply was carried out by locating the mentioned feed mechanism along the optimum location. The first antenna promises a first-class large BW of 8GHz from 16-24GHz. The efficiency of the design in the mentioned operational

band is worth mentioning as it is below 98.6 and above 90%. No considerable change was experienced between the radiation efficiency and the total efficiency as the difference between the two is almost negligible. The antenna has a minimized and efficient structure and it offers reasonably wide bandwidth. Some changes were incorporated in the structure which assured a wide BW of 14GHz, and uppermost efficiency of 0.83. The measured results of the fabricated antenna are better in terms of bandwidth as a BW of 28GHz was demonstrated during the test.

ACKNOWLEDGMENT

The principal author acknowledges the contributions made by Engr. Asif Sultan, who has fabricated this design.

REFERENCES

- [1] Biswas, D., Chandra, V. R., and Dabade V. N., "Design and development of a Ku-band microstrip array antenna", 9th International Radar Symposium India (IRSI-13), NIMHANS Convention Centre, Bangalore, India, pp. 1-4, Dec. 10-14, 2013.
- [2] Jana, S., "The application of Ku-band VSAT systems to single layer hexagonal microstrip patch antenna", International Journal of Modern Engineering Research (IJMER), Vol. 3, No. 2, pp. 1150–1156, Apr. 2013.
- [3] Samsuzzaman, M., Islam, M. T., and Mandeep, J. S., "Triple band X shape microstrip patch antenna for Ku/K band applications", Modern Applied Science, Vol. 7, No. 8, pp.70–77, 2013.
- [4] Islam, M. M., Islam, M. T. and Faruque, M. R. I., "Dual-band operation of a microstrip patch antenna on a duroid 5870 substrate for Ku- and K-bands," The scientific World Journal, Vol. 2013, No.8, pp. 1–10, 2013.
- [5] Ahsan, M. R., Islam M. T., and Ullah M. H., "A simple design of planar microstrip antenna on composite substrate for Ku/K band satellite applications", International Journal of Communications Systems, John Wiley & Sons, Ltd, pp. 1–9, Apr. 2015.
- [6] Ahmed, R. and Islam, M. F. "E-shaped microstrip patch antenna for Ku band", International Journal of Computer Applications, Vol. 80, No. 6, pp.15–19, Oct. 2013.
- [7] Roddy, D., Satellite Communications, 4th ed., McGraw-Hill Companies, Inc., Chapter 1, page 2,2006.
- [8] Chen, Z. N. and Chia, M. Y. W., Broadband Planar Antennas, Design and Applications, John Wiley & Sons Ltd, 2006.
- [9] Kumar, G. and Ray, K. P., Broadband Microstrip Antennas, Artech House, Boston, 2003.
- [10] Surmeli, K. and Turetken, B., "U-Slot stacked patch antenna using high and low dielectric constant material combination in S-Band", General assembly and scientific symposium, URSI, pp. 1-4, 2011.
- [11] Rawat, S. and Sharma, K. K., "Stacked configuration of rectangular and hexagonal patches with shorting pin for circularly polarized wideband performance", Central European Journal of Engineering, Vol. 4, No. 10, pp. 20-26, 2013.
- [12] Weng, L. H., Guo, Y. C., Shi, X. W., and Chen, X. Q., "An overview on defected ground structure", Progress in Electromagnetic Research B, pp. 173-189, 2008.
- [13] Guha, D. Biswas, S., Biswas, M., J. Y. Siddiqui, and Antar, Y. M. M. "Concentric ring-shaped defected ground structures for microstrip applications", IEEE Antennas and Wireless Propagation Letters, Vol. 5, pp. 402-405, 2006.
- [14] Chen, Z. N., Terence, S. P., and Qing, X., "Small printed ultra wideband antenna with reduced ground plane effect", IEEE Transactions on Antennas Propag., Vol. 55, pp. 383-388, 2007.
- [15] Lakrit, S., Ammor, H., Matah, S., Karli, R., Saadi, A., Terhzaz, J., & Tribak, A., "A new small high-gain wideband rectangular patch antenna for X and Ku bands applications", Journal of Taibah University for Science, Vol. 12, no. 2, 202–207, 2018.

- [16] Naik, K.K., and Sri, P.A.V., "Design of Hexadecagon Circular Patch Antenna with DGS at Ku Band for Satellite Communications", *Progress In Electromagnetics Research M*, Vol. 63, 163–173, 2018
- [17] Borah, K., Phukan, A. and Bhattacharyya, S., "Design of light weight microstrip patch antenna on dielectric and magnetodielectric substrate for broadband applications in X-band", *PIER B.*; Vol. 60, pp. 157–168, 2014.
- [18] Fanyaev, I. A. and Kudzin, V. P., "The eight-element Vivaldi antenna array for x-band applications", *International Conference on Antenna Theory and Techniques*; 16– 20 Sept; Odessa, Ukraine; 2013.
- [19] Abbosh, A. M. and Bialkowski M. E., "Uniplanar CPW-fed Slot/ microstrip antenna for X-band applications", *Antennas and Propagation Society International Symposium, APS*; 5–11 July; San Diego, CA; 2008.
- [20] Chodavadiya, V.V., and Aggarwal, S.S., "Microstrip Patch Antenna Design for Ku Band Application", *International Journal of Engineering Research & Technology*, Vol. 3, No. 4, pp. 1707-1710, 2014.
- [21] Azim, R., Islam, M.T., and Misran, N., "Dual polarized microstrip patch antenna for Ku-band application", *Journal of Microelectronics, Electronics Components and Materials, Informacije MIDEM*, Vol. 41, No. 2, pp. 114-117 2011.
- [22] Nor, N.M., Jamaluddin, M.H., Kamarudin, M.R., and Khalily, M., "Rectangular dielectric resonator antenna array for 28GHz applications", *Progress in Electromagnetics Research, C 63*, pp. 53-61, 2016
- [23] Elias, B. B. Q., " A Multi-Band Star Shape Microstrip Patch Antenna", *International Journal of Engineering Research and Applications (IJERA)*, Vol.4, No..43, pp. 28-31, August 2015.
- [24] Rafique, U., Ali, S. A., Khan, M. A., and Ahmed, M. M., " A Wideband Slot-Coupled Inverted Microstrip Patch Antenna for Wireless Communications ", *IEEE International Conference on Emerging Technologies*, Islamabad, Pakistan, pp. 1-4, 2012.
- [25] Singh, P., Singh, S., "Ellipse shaped microstrip patch antenna for ku, k and ka band applications", *International Research Journal of Engineering and Technology*, Vol. 03, No. 02, pp. 1153-1157, Feb-2016.
- [26] Liton Chandra Paul, L. C., Hosain, M.S., Sarker, S., Prio, M. H., Morshe, M., Sarkar, A. K " The Effect of Changing Substrate Material and Thickness on the Performance of Inset Feed Microstrip Patch Antenna", *American Journal of Networks and Communications* ; Vol. 4, No. 3, pp. 54-58, 2015
- [27] Lee, J., Kim, Y.G., An, J., "Enhanced Bandwidth of a Microstrip Antenna Using a Parasitic Mushroom-like Metamaterial Structure for Multi-robot Cooperative Navigation", *Journal of the Korean Physical Society*, Vol. 66, No. 1, pp. 92-95, January 2015.
- [28] Elsaygher, R.M., "Study on bandwidth enhancement techniques of microstrip antenna", *Journal of Electrical Systems and Information Technology*, Vol. 3, No. 3, pp. 527-531, December 2016
- [29] Hasan, B. and Raza, K., "Dual Band Slotted Printed Circular Patch Antenna With Superstrate and EBG Structure for 5G Applications", *Mehran University Research Journal of Engineering and Technology*, Vol. 38, No. 1, pp. 227-238, January 2019.
- [30] CST-Computer Simulation Technology, Documentation, Available on line at: <http://www.cst.com>, 2013
- [31] Darhi, F.A., Soomro, R.A., Memon, S.A., Memon, Z., Memon, M.H., "An Optimized Inset Feed Circular Cross Strip Antenna Design for C-Band Satellite Links", *(IJACSA) International Journal of Advanced Computer Science and Applications*, Vol. 9, No. 5, pp. 238-242, 2018.
- [32] Bhadouria, A.S., Kumar, M., "Wide Ku-Band Microstrip Patch Antenna Using Defected patch and ground", *IEEE International Conference on Advances in Engineering & Technology Research (ICAETR - 2014)*, August 01-02, Kota, India, 2014.