

IMPACT OF SINGLE-MULTI ROLLERS BURNISHING TOOLS ON SURFACE ROUGHNESS AND ROUNDNESS ERROR

Yaser A. Hadi

Research Scholar, Department of Mechanical Engineering Technology, Yanbu Industrial College, Saudi Arabia

ABSTRACT

Burnishing is a simple and effective method for improvement in surface finish and can be carried out using existing lathe machines. It also saves more on production costs than other conventional processes such as grinding. There are many type of burnishing tools developed to satisfy the production requirements for achieving certain surface quality of workpiece, comes at the forefront roller-burnishing tools. Burnishing can be considered as hardened, highly polished steel rollers are brought into pressure contact with a softer piece part. The rotational and longitudinal of the operating workpiece was analyzed before starting the turning and then burnishing. Two roller types of burnishing tools, which are single and multi are used for burnishing carbon steel metal. Graphs are drawn on how these burnishing parameters vary with the variation of the roller burnishing tools. A burnished surface is therefore smoother than an abraded surface with the same roughness height measurement. Experimental work was carried out on a lathe to establish the effect of three roller burnishing tool parameters; namely, burnishing speed, feed rate, burnishing force. The surface roughness and roundness error of the turned test examples were enhanced by burnishing. The consequences of multi-roller burnishing were superior to that of single-roller. The surface roughness increments with low burnishing force at high speed for various feeds utilizing multi-roller burnishing.

KEYWORDS: *Roller Burnishing Tools, Burnishing Parameters, Surface Roughness, Roundness Error*

Article History

Received: 12 Feb 2019 | Revised: 21 Feb 2019 | Accepted: 11 Mar 2019

INTRODUCTION

The studies determined working parameter ranges to be critical in the burnishing process, since surface qualities were attainable over wide setting ranges. In a hard roller burnishing operation, the component surfaces roll under high pressures, therefore, the roughness peaks are flattened and the quality of the workpiece surface is improved, F. Klocke. For the treated material in this investigation, the best consequences of surface roughness was acquired with a range of ball burnishing forces, rate it 80, 170, and 250. The base surface roughness was acquired at a feed rate 0.11 mm/rev. what is more, a speed of 60.3 m/min. The littler roundness mistake additionally can be accomplished by utilizing burnishing velocities running between 60.3 to 85.7 m/min. with a polishing feed of 0.11 mm/rev.

Improvements in the surface roughness and increases in the surface hardness achieve by the application of both ball burnishing and roller burnishing with the non-ferrous metals under consideration, Adel [1]. A number of different manufacturing processes, among which roller burnishing is distinguished by the following substantial advantages, can

achieve the required surface layer properties: high and deep-reaching compressive residual stresses and excellent surface quality, F Klocke [2]. The determination of optimal process parameters in order to achieve a defined surface layer requires an elaborate experimental set-up and subsequent time-consuming and cost-extensive measurements. El-Tayeb [3], investigated in his study, that the potential for using the roller burnishing process to improve surface roughness and hardness of thermoplastics and thermosets, and studied the effect of roller burnishing parameters such as burnishing force, speed, feed, and roller width contact. Pavana Kumara [4], made an attempt to investigate the effect of fine silicon carbide abrasive particles in between roller burnishing tool and cylindrical components of EN24 steel.

For burnishing experiments, three process parameters considered include spindle speed S , feed rate F , and burnishing force F . Trung [5], investigated the relationships between machining parameters and surface characteristics of the interior roller burnishing using response surface method model. Jawalkar [6], aimed to apply Taguchi's design of experiments on the specimens find optimized values for enhancing the surface quality and hardness economically, where the surface roughness is the main response variable and the process parameters under consideration are spindle speed, tool-feed, number of passes and lubricants.

Features of burnishing include a good roughness, as well as improvement of mechanical characteristics of the surface due to implementation of compressive stresses into the surface layer, Liviu Luca [7]. V. Jaya Prasad [8] made a hardened steel roller as a tool and pressed against AA6063 cylindrical rod. It is observed after burnishing that the surface finish and corrosion resistance were improved. G Varga [9], dealt with the process improvements of surface roughness and shape correctness and change of these attributes with the burnishing parameters on diamond-burnished low alloyed Aluminium shafts. Roller burnishing produces better and accurate surface finish on Aluminum work piece in minimum time, J.N. Malleswara Rao [10].

The roller burnishing for minimizing the roundness error and increasing surface micro-hardness of cylindrical parts, is proposed. T. A. El-Taweel [11] studied the roundness error by adding applied voltage and inter-electrode gap parameters, to the applied burnishing force and rotational speed. M.H. El-Axir [12] has been obtained a significant improvement in out-of-roundness and surface microhardness in aluminum alloy 2014 workpiece without the need for the difficult to set-up grinding equipment normally used for inner surfaces super-finishing. To explore the optimum combinations of the process parameters in an efficient and quantitative manner, the experiments were designed based on the response surface methodology technique. Finally, the results obtained are compared with the work done by other researchers and the results found are to be closer.

Selection and Setup the Roller Burnishing Tools

Roller burnishing tools are designed for orthogonal burnishing outside diameters. It is offered with both a hardened steel and a carbide roll. For cost savings in mind, all of manufacturers want to use a roller-burnishing tool to complete the processing of all surfaces and all dimensions of a workpiece, which is called single and multi-burnishing tools. For this work, roller-burnishing tools have been selected to show how to complete the processing of outer shaft surfaces of the workpiece material profile.

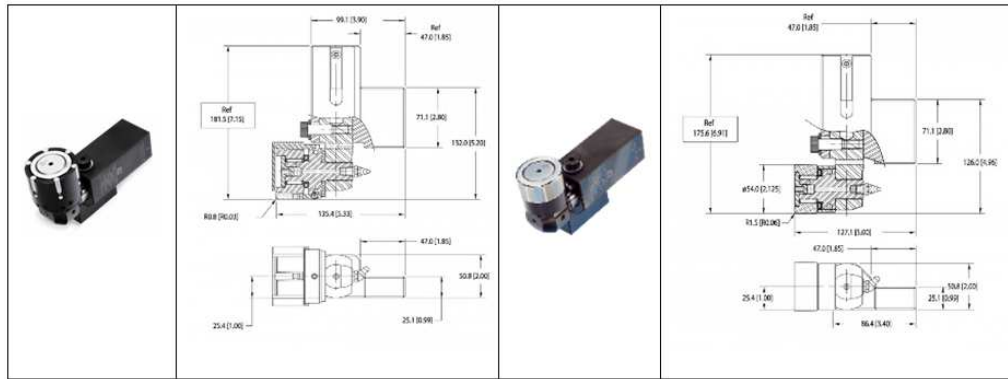

a. Multi Roller Burnishing Tool

b. Single Roller Burnishing Tool

Figure 1: Roller Outer Diameter Burnishing Tools



a. Creating a Surface Utilizing a Turning Tool

b. Localizing and Start Burnishing Process

Figure 2: Setup of Side Turning and Roller Burnishing Tools

Figure 2 a, shows how a lightweight lathe can be used to flow metal, as to create a very smooth surface. Also, create a localized point of contact greater than the compressive yield strength of the material. While the cross slide, pressure is not especially high, a burnishing tool would be preferable by removing the side-turning tool and replacing with appropriate sized burnishes with coolant running on the selected part, figure 2b. The burnishing edge of the tool is perpendicular to the work piece axis.

Formulation of the Experiment

Specimen

Machining trials were carried out on carbon steel of 0.18%C., which has a wide range of applications in the industry. The chemical composition is 0.18%C, 0.21%S, and 0.55%Mn, and mechanical properties are $\sigma_u = 380 \text{ N/mm}^2$, and The measured hardness was 121 HB. The specimen has a length of 100 mm and diameter of 50 mm. It was clamped to one side with the chuck and supported on the other side according to figure 2.

Adjustable Burnishing Parameters

The three primary factors in any basic burnishing operation are burnishing speed (v , m/min), feed rate (f , mm/rev), and burnishing force (F , N), to get a smooth surface and achieve the purpose of furnishing. Since roller, burnishing displaces metal rather than removing it, therefore, neglect depth of burnish. These three factors are the ones the operator can change by adjusting the controls right at the machine. Important factors like, tool rigidity, tool geometry, and kind of material has an influence, of course, in determining the behavior of burnish-ability of mechanical workpiece. Taking into account, when starting burnishing operations the side and end burnishing edge, by means of small burnishing force. Although, perpendicularity burnishing techniques are used for the experiments. The applied burnishing processes

parameters and conditions are listed in table 1.

Table 1: Burnishing Parameters and Conditions

Burnishing feed(<i>f</i>) mm/rev.	0.048, 0.096, 0.176, 0.272, and 0.336
Burnishing speed (<i>v</i>) m/min.	16.8, 47.36, 96.48, 137.12, and 186.4
Burnishing force (<i>F</i>)N	112, 272, and 400
Burnishing conditions	burnishing fluid-coolant

Surface Finish Measurement

Surface roughness can be measured by a variety of instruments including both surface contact and non-contact types. By far the universal technique is to measure surface roughness with a stylus contact-type instrument that provides a numerical value for surface roughness, figure 3. Stylus is a shop floor surface roughness-measuring instrument, which traces the surface of parts, calculates their surface roughness based on roughness standards and displays results. The stylus is drawn across the surface to a distance of 2.5 mm and generates electrical signals that are proportional to the changes in the surface. It attached to the standard detector unit will trace minute irregularities of surface of workpiece. The only disadvantage is that the surface to be assessed must be aligned precisely with the datum of the instrument.

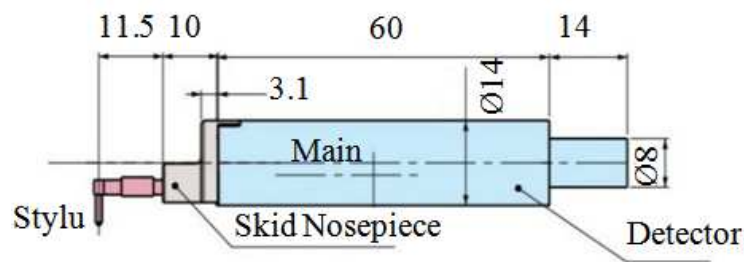

Figure 3: Scheme of Portable Surface Roughness

Burnishing Process

The workpiece to be burnished is clamped by the three-jaw chuck of the lathe and guided from other side by the lathe tailstock. The burnishing process was applied after turning without releasing the workpiece from the lathe chuck to keep the same turning alignment. Slide burnishing were carried out in one clamping process to minimize the concentric runout in burnishing. Initial turning conditions were unified for all workpieces as follows: Turning parameters are; speed: 57 m/min., depth of cut: 0.25 mm, feed rate: 0.32 mm/rev and tool nose radius of 0.2 mm. As the aim of this investigation was to study the effect of the single and multi-roller burnishing tools in burnishing process upon final surface texture (roughness and roundness), and to study the effect of burnishing parameters namely burnishing feed, burnishing speed, and burnishing force upon final surface texture. A hard roller is pressed against a rotating cylindrical workpiece and parallel to the axis of the work piece on lathe.

In this work, produced surface roughness, and roundness error were measured after burnishing process. The surface finish of the burnished specimens was measured using Mitutoyo Talysurf model. The measurements were carried out across the lay using diamond stylus of radius 2.5 microns and adjusted meter cut-off 0.8 mm. Average values are calculated for readings of surface roughness, Ra were taken for each specimen. Roundness error was measured using Mitutoyo RoundTest. The pre-burnished surface of the test specimens were monitored by measuring of surface roughness and roundness values for five specimens under the same conditions.

Results and Discussion

To study the effectiveness of the multi-roller burnishing tool, and effect of burnishing parameters on the burnished surface roughness and roundness, the experimental results are plotted as shown in figures 4, 6, and 7. The relations are drawn for single-multi-roller burnishing to study, which one has more effect that is appreciable. The results of burnishing tests and discussion are as follows:

Effect of Burnishing Feed Rate Parameter on Surface Roughness

As mentioned before five burnishing feeds were selected for these tests. The effect of feed rate (f) was studied with constant burnishing speed of 96.48 m/min. and at different values of burnishing force (F) to study the interaction between the two parameters (f , F). The relations are plotted as shown in figure 4. The results of using single roller burnishing are shown in figure 4a, while figure 4b shows the results of multi-roller burnishing.

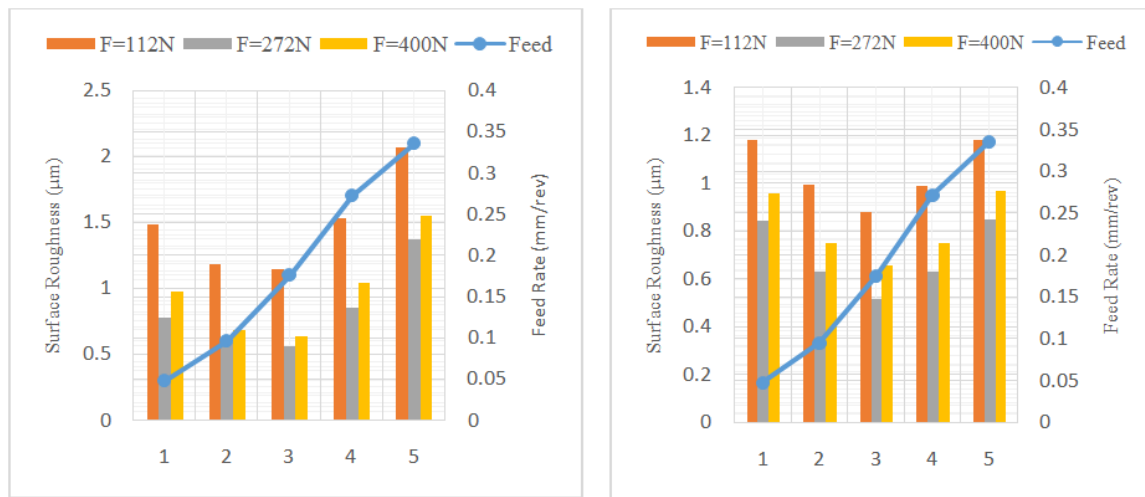

a. Single Roll Burnishing

b. Multi Roll Burnishing

Figure 4: Effect of Burnishing Feed on Surface Roughness for Different Burnishing Forces

The resulted surface roughness values in both figures. are considerably reduced compared to machined surface roughness ($R_a = 4.0\mu\text{m}$) i.e. before burnishing process, which gives the conclusion that the burnishing tool is effective. The trend of the relation between feed rate and the burnished surface roughness, as shown in figure 4, are approximately the same for single and multi-roller burnishing. First, the surface roughness slightly decreased as the feed rate increased. Then when feed rate increased above 0.176 mm/rev., the surface roughness was increased.

To interpret the above phenomenon, a schematic representation of roller burnishing process is shown in figure 5. It shows increasing of feed increasing the distance between the peaks that lead to increasing of surface roughness. Using of very low feed values caused reduction of area opposite to the tool, which increased the compressive stress, more which caused overhardening that may cause flaking for the surface and deteriorate the surface finish. The pattern of the connection between feed rate and the burnished surface unpleasantness, as appeared in figure 4. First, the surface roughness marginally decreased as the feed rate increased. At that point, when feed rate increased above 0.176 mm/rev. the surface roughness was expanded. Utilizing of low feed values caused decrease of territory opposite to the tool, which increased the compressive stress, more which caused overhardening that may cause chipping for the surface and fall apart the surface finish.

The minimum surface roughness was obtained with a burnishing force of 272 N, at a feed rate of 0.176 mm/rev. After this feed esteem the surface roughness expanded as the feed rate expanded. The maximum surface roughness esteems were acquired with a burnishing force of 112N. The enhancement of surface roughness while increase the force from 112N to 272N is normal as the increase of the force increment the profundity of penetration bringing about packing more severities and builds the metal stream that prompts the filling of more valleys that were existed on subsurface due to the previous turning process. When the burnishing force increased from 272N to 400N, the surface roughness was increased. This may be due to the overhardening and consequently flaking of the surface layer. The increase of force above a certain value (272N) also increases the bludge in front of burnishing roller and widens the region of plastic deformation, which damages the burnished surface and increased the surface roughness.

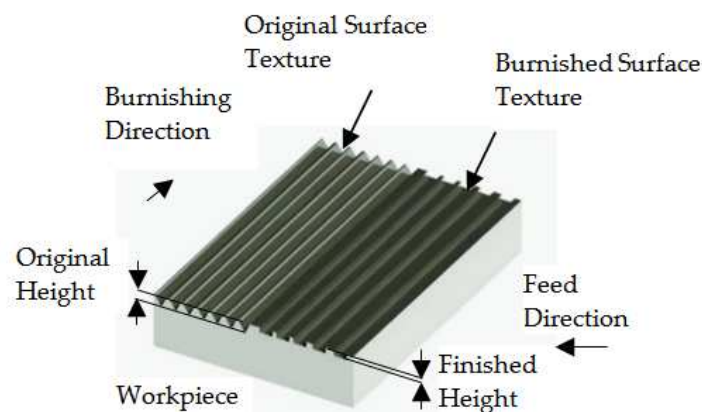

Figure 5: Schematic Representation of the Burnishing Process

Effect of Burnishing Speed Parameter on Surface Roughness

The relations between burnishing speed and surface roughness are shown in figures 6 and 7. Figure 6, shows the effect of burnishing speed on surface roughness at constant feed rate of 0.176 mm/rev, under different burnishing forces. While figure 7, shows this effect at constant force of 272N and at different feed rates. Referring to figure 6a, it can be noticed that, with a single-roller the increasing of speed decreases the surface roughness for the force 112N, but for the forces 272N and 400N surface roughness first decreased with the increase of speed up to a speed of 60.3 m/min. then slightly increased for further increasing of speed. The rate of increasing with a force of 400N is higher than that with the force of 272N. This may partially, be due to chatter, which is usually existed at high speeds with high forces.

Figure 6a, likewise demonstrates that, at low speeds the surface roughness is ideal at a force of 400N, while the most exceedingly one was acquired with a force of 112N. This can be described to the way that, at low speeds the deformation action of the roller is high which weakens the surface roughness. For this situation, high force is required to press the pinnacles of the burnished surface. Nevertheless, at high speeds the turnaround was valid. Figure 6a, likewise demonstrates that, the minimum surface roughness was obtained at a speed of 96.48 m/min. what is more, burnishing force of 272N at 0.176 mm/rev. feed.

In circumstance where multi-roller were utilized for burnishing figure 6b, it tends to be seen that, utilizing low burnishing force (112N) the surface roughness is expanded as the speed expanded. A similar outcome was acquired when utilizing the power 272N yet with a lower slope. While with burnishing force of 400N, the burnished surface roughness is reduced as the speed increment. It very well may be seen from the figure. additionally that, the scope of variety of surface

roughness for various speeds at the powers 272 and 400N is least than that of single roller burnishing. The utilization of a multi-roller as talked about before keeps this versatile distortion and avoids spinning of the workpiece, which decreases vibration between the burnishing tool and workpiece causing minimization for the speed variety's impact on the presence of vibration among burnishing tool and workpiece. At low speed, additionally (16.8 m/min.) the surface roughness for the force 400N is more prominent than different forces and this might be expected to overhardning caused for the workpiece surface under the action of this force

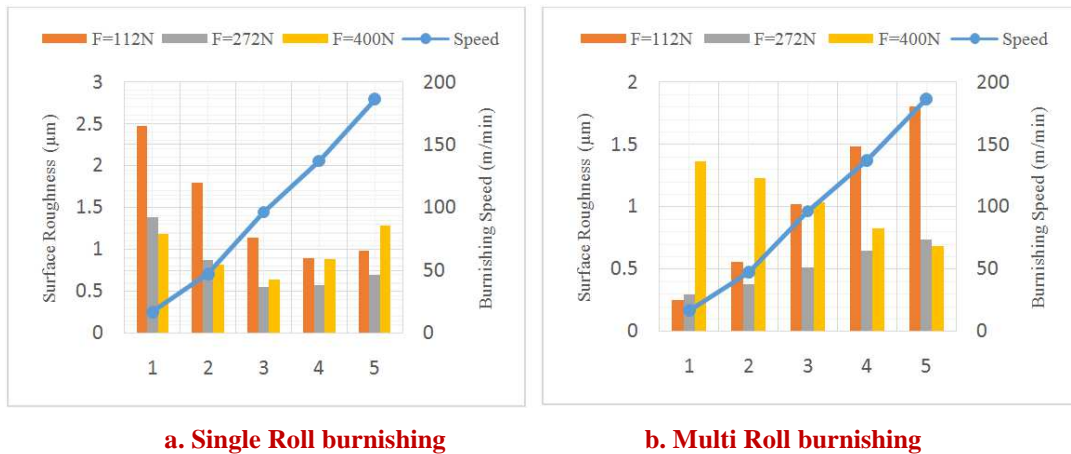
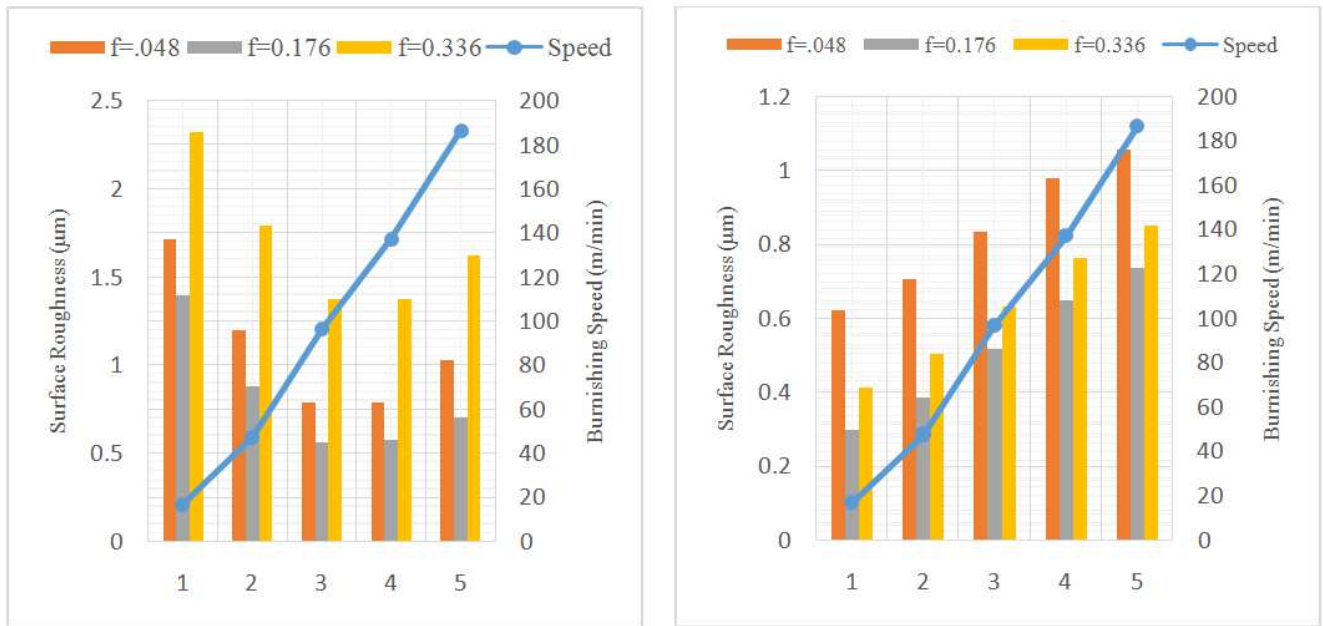

Figure 6: Effect of Burnishing Speed on Surface Roughness for Different Burnishing Forces

It can be seen also from figure 6, that, the range of surface roughness obtained by multi-roller burnishing is less than that obtained by single-roller burnishing. For multi-roller, burnishing better surface roughness can be achieved using low values of forces with low speeds, or using high forces with high speeds. It tends to be seen additionally from figure 6, that, the scope of surface roughness acquired by multi-roller burnishing is not as much as that gotten by single-roller burnishing. For multi-roller burnishing better surface roughness can be accomplished utilizing low estimations of forces with low speeds, or utilizing high forces with high speeds. If there should arise an occurrence of single-roller burnishing, the surface roughness diminishes with the expansion of burnishing rate until 96.48 m/min. speed and after that somewhat increments with the burnishing speed as appeared in figure 6a.



a. Single Roll Burnishing

b. Multi Roll Burnishing

Figure 7: Effect of Burnishing Speed on Surface Roughness at Different Feed Rates

Effect of burnishing speed on surface roughness at different feeds under constant burnishing force (272N) is shown in figure 7. In case of single roller burnishing, the surface roughness decreases with the increase of burnishing speed until 96.48 m/min. speed and then slightly increases with the burnishing speed as shown in figure 7a. The disintegration of surface roughness with the expansion of rates is authentic as the multi-roller guided the example with no authorization for elastic deformation. This may make the framework fall in chatter with the expansion of paces. At high speeds, there is likewise a lubricant misfortune because of lacking time for it to infiltrate between the roller and the burnished surface, which is fundamental for multi-roller burnishing. When all is said in done for single and multi-burnishing the base surface roughness can be accomplished utilizing 0.176 mm/rev. feed, and at a roughness rate of 96.48 m/min. for single ball roughness, and 16.8 m/min. for multi-roller burnishing. Figures 6 and 7, additionally demonstrates the scopes of surface roughness for multi-roller burnishing is littler than that for single-roller.

Effect of Burnishing Feed Rate Parameter on Roundness Error

Roundness error assumes an essential role in the efficiency of burnishing process, and this error could be because of the forces created amid burnishing. This might be likewise because of misalignment of the workpiece amid burnishing. Figure 8, demonstrates the impact of feed on the burnished surface roundness error for single-multi-roller burnishing strategies. Figure 8a, appears, for single roller burnishing, that the increase of feed from 0.048 to 0.176 mm/rev, diminishes the roundness error. Subsequently further increment of feed above 0.176 mm/rev. increases roundness error. This can be clarified by the way that, at low feeds the twisting activity of the roller is gathered because of its little hub development that may cause shear of subsurface layer (chipping) prompting crumbling of roundness error. Increasing of roundness error past the feeds above 0.176 mm/rev is expected due of the increase of pivotal separation moved by the instrument amid shining procedure. In this way, for single-roller burnishing it is desirable over abstain from burnishing at low feeds and in as well as at very high feeds.

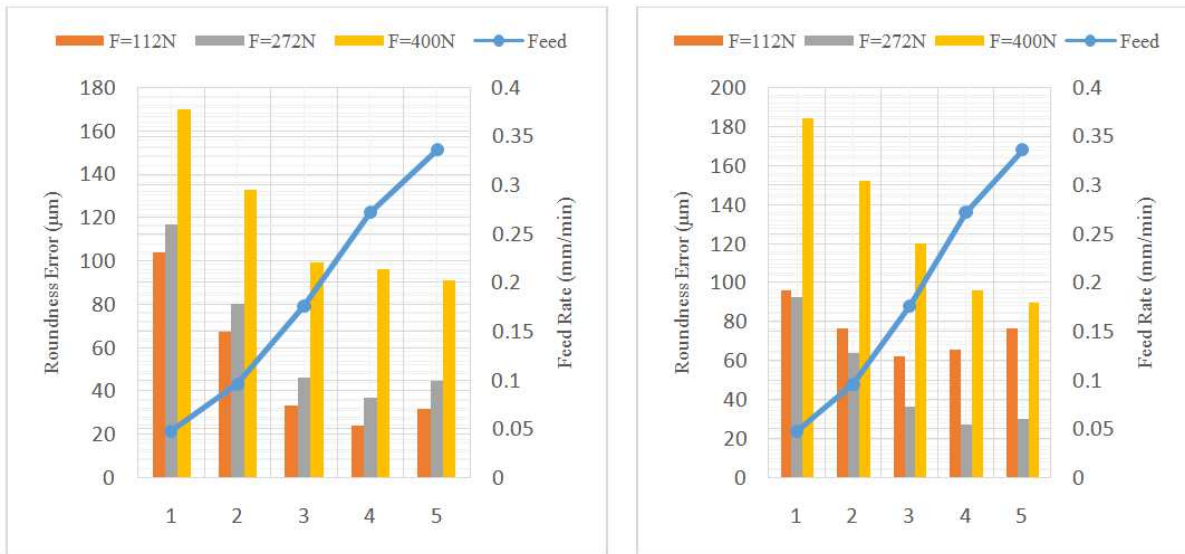

a. Single Roll Burnishing

b. Multi Roll Burnishing

Figure 8: Effect of Burnishing Feed Rates on Roundness Error at Different Burnishing Forces

For multi-roller burnishing figure 8b, the connection displayed roughly indistinguishable pattern from in figure 8a, for single-roller burnishing. Be that, as it may, the feed rate limit at which the roundness error starts to increment expanded from 0.176mm/rev. to 0.336 mm/rev. as appeared in figure 8b. Figure 8, also shows that the roundness error for multi-roller burnishing is smaller than that of single-roller, where, the increase of force decreases roundness error; this is due to compressing more asperities on the burnished surface. Further increase of the force increases roundness error because shear failure occurred for subsurface layer. This lead the manufacturer to give more attention for the value of burnishing force as it affects the result of burnishing process. Figure 8b, additionally demonstrates the expansion of power from 112N to 272N abatements roundness error. This is due to compressing more asperities on the burnished surface with the force of 272N. Further increment of the force to 400N increases roundness error since shear disappointment happened for subsurface layer under the activity of this force, which thus builds roundness error. This lead the manufacturer to give more attention for the value of burnishing force as it affects the result of burnishing process.

Effect of Burnishing Speed Parameter on Roundness Error

Impact of burnishing speed on roundness error is appeared in figures 9 and 10. Figure 9, was plotted to contemplate the cooperation between speed and force, while figure 11, for the connection between speed and feed. For single ball burnishing, figure 9a, the expansion of speed diminish roundness error for all of burnishing forces levels. Figure 10b, demonstrates that at low force of 112N, the expansion of speed expanded roundness error for multi-roller burnishing. Figure 9, additionally demonstrates the best aftereffect of roundness was acquired with multi-roller burnishing by utilizing burnishing force of 272N. Figure 9; also show that the best result of roundness error was obtained with multi-roller burnishing while using burnishing force of 272N.

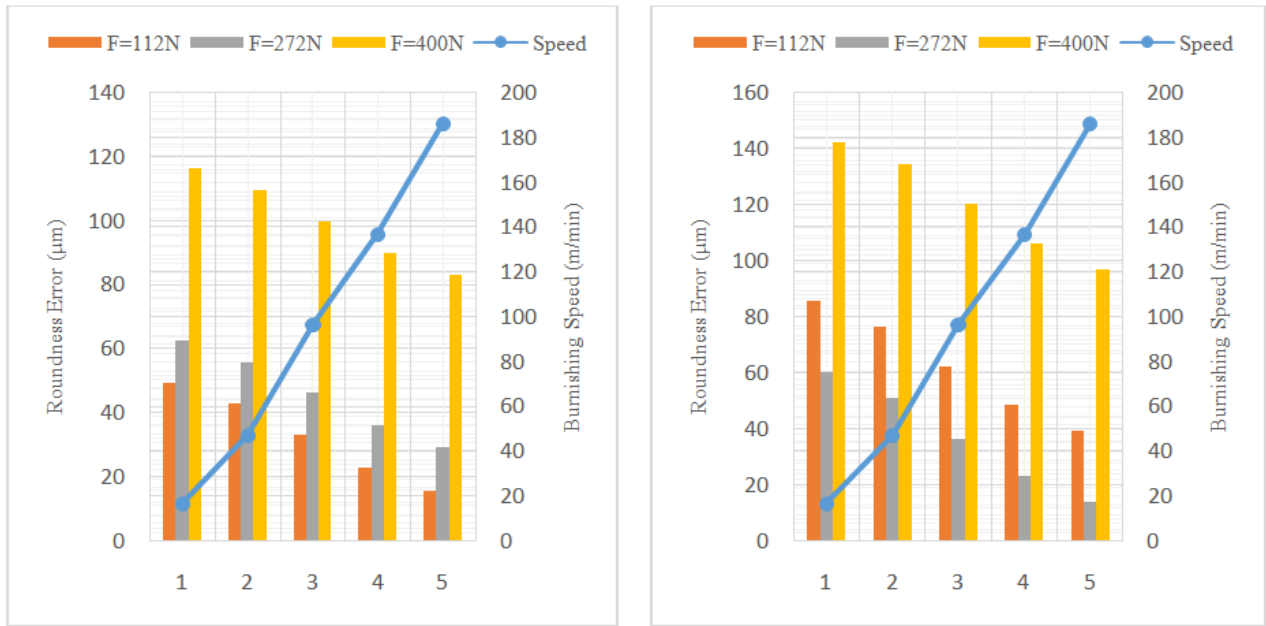

a. Single Roll Burnishing

b. Multi Roll Burnishing

Figure 9: Effect of Burnishing Speed on Roundness Error at Different Burnishing Forces

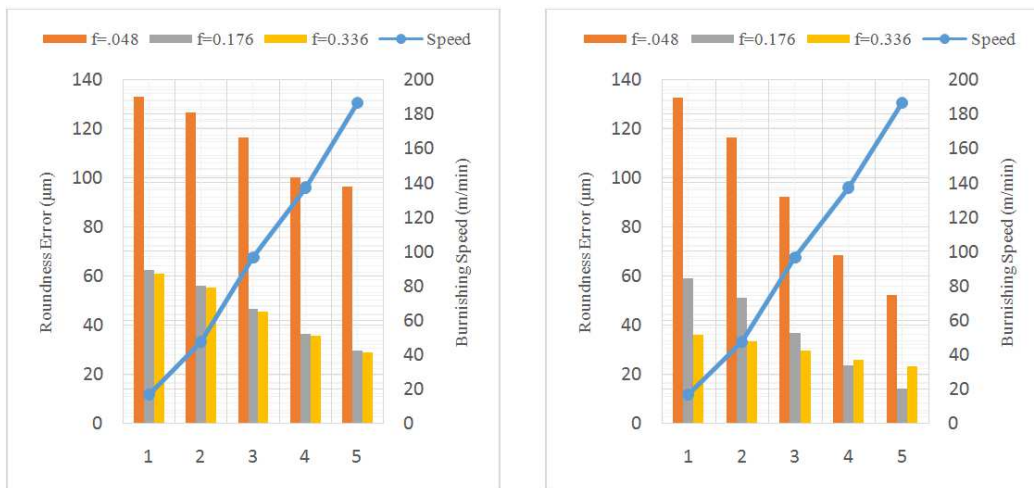

a. Single Roll burnishing

b. Multi Roll burnishing

Figure 10: Effect of Burnishing Speed on Roundness Error at Different Feed Rates

Figure 10, demonstrates the impact of burnishing speed at different feed rates. As appeared in the figure for all feeds esteems, roundness error is diminished as the speed increased with the exception of single-roller burnishing at feed of 0.336 mm/rev. For this situation the expansion of speed above 96.48 m/min. expanded roundness error. This might be because of, the increase of developed material in front of the surface, prompting inordinate vibration which decay the roundness error. The small roundness error also can be achieved by using burnishing speeds between 96.48, and 137.12 m/min. with a burnishing feed of 0.176 mm/rev. Figures 9 and 10, illuminate the viability of the burnishing tool, and furthermore the ability of multi-roller burnishing in delivering smooth surfaces than single-roller burnishing.

Factors Influencing Surface Roughness and Roundness Error

Generally, it is found that the most factors influencing surface roughness and roundness error in burnishing are:

- *Depth of burnishing*: As it was not taken into consideration during this work, but have to point out that only increasing the depth of burnish increases the burnishing resistance and the amplitude of vibrations. As a result, burnishing temperature also rises. Therefore, it is expected that surface quality will deteriorate.
- *Feed Rate*: Experiments show that as feed rate increases surface roughness also increases due to the increase in burnishing force.
- *Burnishing speed*: It is found that an increase of burnishing speed generally improves surface quality.
- *Engagement of roller burnishing tool*: This factor acts in the same way as the depth of burnish.
- *Burnishing tool wears*: The irregularities of the burnishing edge due to wear are reproduced on the machined surface. Apart from that, as tool wear increases, other dynamic phenomena such as excessive vibrations will occur, thus further deteriorating surface quality.
- *Use of burnishing fluid*: The burnishing fluid is generally advantageous concerning surface roughness because it affects the burnishing process in three different ways. Firstly, it absorbs the heat that is generated during burnishing by cooling mainly the tool and work surfaces. In addition to this, the burnishing fluid is able to reduce the friction between the roller face and the machined surface. Lastly, the washing action of the burnishing fluid is considerable, as it consists in removing chip fragments and wear particles. Therefore, the quality of a surface burnished with the presence of burnishing fluid is expected to be better than that obtained from dry burnishing.
- *Burnishing force components*: It should be noted that force values cannot be set a priori, but are related to other factors of the experiment as well as to factors possibly not included in the experiment, i.e. force is not an input factor and is used as an indicator of the dynamic characteristics of the work piece, burnishing tool, and machine system. Mate, consider it as one of the main parameters to achieve the best surface finish, [13].
- Finally, the set of parameters including the above mentioned parameters that are thought to influence surface roughness, have been investigated from the various researchers, [14, 15].

CONCLUSIONS

The aim and objective of this study were to study the influence of single and multi-roller burnishing tools on metal turning process, and to evaluate the measuring surface roughness. After reviewing all graphs related to burnishing speed, burnishing force, and feed rate, they are the main effect parameters on the surface roughness. From above study, it is clear that contact surface of a single-multi-roller burnished tool is a most important parameter for getting good surface finish. The result obtaining from the conclusion is state as a roller surface may be increased then effect on burnished force also get increases. In addition, surface roughness gets decreases with respect to increasing in burnishing speed. In addition, increase in feed rate can also increase the surface roughness. In addition, the results achieved with roller burnishing are impressive thanks to greater surface resistance and larger contact area ratios due to plateau formation. The results obtained from various experimental tests are useful in selecting appropriate burnishing tool for various conditions of speed, feed and depth of furnish, which leads to economical burnishing and improved productivity. All figures show that, the best surface

roughness can be obtained with multi-roller burnishing. This is true as the use of a single roller making the workpiece to be elastically deformed along its longitudinal direction under the action of the normal force.

REFERENCES

1. Adel Mahmood Hassan. *The effects of ball- and roller-burnishing on the surface roughness and hardness of some non-ferrous metals. Journal of Materials Processing Technology.* 72(3): 385-91. 1997.
2. F. Klocke, J. Liermann. *Roller burnishing of hard turned surfaces. International Journal of Machine Tools and Manufacture.* 38 (5–6): 419-23. 1998.
3. F Klocke, V Bäcker, H Wegner, M Zimmermann. *Finite Element Analysis of the Roller Burnishing Process for Fatigue Resistance Increase of Engine Components. Proceedings of the Institution of Mechanical Engineers, Part B: Journal of Engineering Manufacture.* 8. 2010.
4. N S M El-Tayeb, K O Low, P V Brevern. *The influence of roller burnishing process on hardness and roughness of cylindrical polymer surfaces. Proceedings of the Institution of Mechanical Engineers, Part J: Journal of Engineering Tribology.* November. 14. 2008.
5. Pavana Kumara1, G. K. Purohit. *Influence of Abrasives in Roller Burnishing Process on Microhardness Using Factorial Design. American Journal of Mechanical and Industrial Engineering.* 2(2). 111-16. 2017.
6. Trung-Thanh Nguyen and Xuan-Ba Le. *Optimization of interior roller burnishing process for improving surface quality. Journal Materials and Manufacturing Processes.* 33(11). 1233-41. 2018.
7. C. S. Jawalkar and R. S. Walia. *Study of roller burnishing process on En-8 specimens using design of experiments. Journal of Mechanical Engineering Research.* (1). 38-45. 2019.
8. Liviu Luca, Sorin Neagu-Ventzel, Ioan Marinescu. *Effects of working parameters on surface finish in ball burnishing of hardened steels 2005.* 29(2), 253-56. 2005.
9. Nares Kumar. *Experimental investigation of effect of roller burnishing process parameters on surface roughness and surface hardness of C40E steel. Int. J. Machining and Machinability of Materials.* 18, 1/2. 2016.
10. V. Jaya Prasad, K. Sam Joshi, V.S.N. Venkata Ramana, R. Chiranjeevi. *Effect of Roller Burnishing on Surface Properties of Wrought AA6063 Aluminium Alloys. Materials today: proceedings.* 5(2):8033-40. 2018.
11. G Varga, V Ferencsik. *Investigation of the influence of different burnishing parameters on shape correctness and residual stresses. XXIII International Conference on Manufacturing. IOP Conf. Series: Materials Science and Engineering.* 2018.
12. J.N. Malleswara Rao, A. Chenna Kesava Reddy, and P.V. Rama Rao. *Evaluation of Optimum Values of Surface Roughness on Aluminum Work Piece using Roller Burnishing. International Journal of Engineering Research and Technology.* 4(3). 0974-3154. 293-303. 2011.
13. T. A. El-Taweel, S. J. Ebeid. *Effect of hybrid electrochemical smoothing–roller burnishing process parameters on roundness error and micro-hardness. The International Journal of Advanced Manufacturing Technology.* 42(7). 643-55. 2. 2009.

14. M.H. El-Axir, O.M. Othman, A.M. Abodierna. *Improvements in out-of-roundness and microhardness of inner surfaces by internal ball burnishing process.* *Journal of Materials Processing Technology.* 196(1–3). 120-28. 2008.
15. D.M. Mate, G.K. Awari, J.P. Modak. *Experimental investigation of parameters by burnishing process on H20 aluminum alloy.* *International Journal of Applied Engineering* 2011. 1 .55-58. 2011.

