

# DESIGN AND CONSTRUCTION OF AN RFID BASED E-ATTENDANCE REGISTER

M.Ehikhamenle, R.O.Okeke

Department of Electronic and Computer Engineering,  
University of Port Harcourt, Choba, Rivers State, Nigeria  
Email:mattinite4u@yahoo.com, [remyokeke@yahoo.co.uk](mailto:remyokeke@yahoo.co.uk)

**ABSTRACT** This work is about the design and construction of an RFID based electronic attendance register. It takes advantage of the wireless and cheap RFID technology in combination with a real time clock module and an SD card module to take automated attendance and log the data for further analysis if desired. It is microcontroller based and the Arduino Micro-controller was used as well as the MFRC522 RFID module. Each subject of the register would be represented by a tag whose identity is already stored, which when placed close to the reader would cause the micro-controller to log the subject's information in an SD card. The stages involved in this research are the design stage where the whole system was designed, the coding stage where the code for the microcontroller was written and debugged and the final build stage where everything was put together.

**Keyword;** MFRC522 RFID module, Arduino, attendance register, debugged, SD card. Register, reader

## 1. INTRODUCTION

Attendance is the concept of people, individually or as a group, appearing at a location for a prescheduled event. Measuring attendance is a significant concern for many organizations, which can use such information to gauge the effectiveness of their efforts and to plan for future efforts; it also goes a long way in sporting and entertainment industries to determine the success of such events. Radio Frequency or waves has been a vital part in electronics and communication, it denotes electromagnetic waves that have a wavelength suited for use in radio communication.. It has over the years through detailed study and research produced result of very unique and ingenious applications in the field of Engineering as a whole such applications areas include; transportation, health-care, agriculture, the hospitality industry, academic and business settings to mention but a few. These unique applications of the concept of radio waves have made life easier and led to the solutions to many of man's problems directly or indirectly. The impact of Radio frequency solutions ranges from the use of a car key, the use of a card to access buildings, validation of bus tickets to more sophisticated usage such GSM phones. The major problems faced by organizations with regards to attendance data collection are; time consumption of manual attendance systems, resources wastage, and data inconsistency. Radio Frequency Identification (RFID) is one of the automatic identification technologies more in vogue nowadays. There is a wide research and development in this area trying to take maximum advantage of this technology, and in coming years many new applications and research areas will continue to appear. The information contained within an RFID tag's electronic chip depends on its application. It may be a UII, Unique Item Identifier or an EPC Electronic Product Code, once this identifier has been written into the electronic circuit of the tag, it can no longer be modified, only read. This principle is called WORM (once written read multiple). Some electronic chips have another memory in which users can write, modify and erase their own data. These memories vary in size from few bits to tens of kilobytes This sudden interest in RFID also brings about some concerns, mainly the security and privacy of those who work with or use tags in their everyday life.

As for system development and implementation, it should be able to help in managing their student attendance systematically. The system must have database that contains employee/student information and it must be able to help lecturer to manipulate data, update database, alert manager accordingly, and also nice interface to make it easier to use. Finally, the attendance system must be user friendly for commercial purpose.

Our project is going to solve these problems by using RFID technology. Radio Frequency Identification (RFID) is an automatic identification method, relying on storing and remotely retrieving data using devices called RFID tags or transponders. So the RFID is a wireless identification. Normally the RFID system comprises of two main parts are RFID Reader and RFID Tag.

## 2. RELATED WORKS

Until the mid-18th century, most people led simple one-dimensional lives as small-scale farmers, anglers, or artisans, and their work output depended on natural forces such as the sun and the wind. The concept of time management depended on several factors such as; agricultural tempos, tides, weather, and seasons. For instance, daylight hours determined work hours, inclement weather determined holidays, and productivity depended on the variations of the growing season. The sun and the moon, and disposition of the laws of the universe determined time management. (Curtin et al, 2006). The industrial revolution and subsequent developments enabled humans to harness nature for their ends. Big machines in factories ended the dependence on the weather, and the invention of electricity and deployment of artificial lighting rendered the concept of daylight hours insignificant. (Curtin et al, 2006). The invention of mechanical clocks made it possible to manage time, but the notion of time was still different from what it is today. The earliest of clocks could keep time to the second, but most early-clocks came only with an hour hand and indicated time to the closest quarter hour. People in the early industrial revolution still did not consider accounting for their time to the second to be important or necessary. (Davis, 2004). The history of time management in the early 20th century ran parallel to the evolution of management science. Taylor's scientific approach to management which was aimed at shop management, centered on the principle of effective time management. He attributed inefficiency of his worker to tendencies to work slowly, without any incentives to work fast. He advocated establishing specific work targets and paying workers for the tasks and goals met. This mandated better usage of time and became the basis for modern time management approaches. (Clarke, 2005). RFID (Radio-Frequency Identification) is a technology for automated identification of objects and people. Human beings are skilful at identifying objects under a variety of challenge circumstances. For example, a bleary-eyed person can easily pick out a cup of coffee on a cluttered breakfast table in the morning. Whereas, computer vision performs such tasks poorly but RFID may be viewed as a means of explicitly labelling objects to facilitate their "perception" by computing devices. (Curtin et al. 2006) Most histories of RFID technology can be traced back to the radio-based identification system used by Allied bombers during World War II. During the war bombers could be shot down by German anti-aircraft artillery, so they had a strong incentive to fly bombing missions at night because planes were harder for gunners on the ground to target and shoot down. Of course, the Germans also took advantage of the cover that darkness provided. Early Identification Friend or Foe (IFF) systems made it possible for Allied fighters and anti-aircraft systems to distinguish their own returning bombers from aircraft sent by the enemy. These systems, and their descendants today, send coded identification signals by radio: An aircraft that sends the correct signal is deemed to be a friend, and the rest are foe. Thus, radiofrequency identification was born. (Farragher, 2009) Shortly after the war, an engineer named Harry Stockman realized that it is possible to power a mobile transmitter completely from the strength of a received radio signal. His paper "Communication by Means of Reflected Power" introduced the concept of passive RFID systems. Work on RFID systems as we know them began in earnest in the 1970s. In 1972, Kriofsky and Kaplan filed a patent application for an "inductively coupled transmitter-responder arrangement. The system used separate coils for receiving power and transmitting the return signal. In 1979, Beigel filed a new application for an "identification device" that combined the two antennas; many consider his application to be the landmark RFID application because it emphasized the potentially small size of RFID devices. (Sorrells, 2000)

## 3. METHODOLOGY

This research concept is based on a microcontroller approach that digitalizes analogue signals obtained from sensors used to monitor the receipt of signals from radio frequency chips implanted in tags and cards. It monitors persons or object and keeps record or a register of their attendance automatically through the aid of a timing mechanism, and stores the register information on an SD card through the SD Card Module incorporated into the project. The register information that is stored in the SD card can then be easily gotten by removing the SD card from the module and copying out the data for further manipulation through the various softwares available such as SPSS, Microsoft Access, and Excel.

### A. Functional Unit Description

Every circuit has a number of functional units that makes up that circuit. In order to have a good, durable and cost effective design, the choice of materials used was based on availability, efficiency, durability and cost.

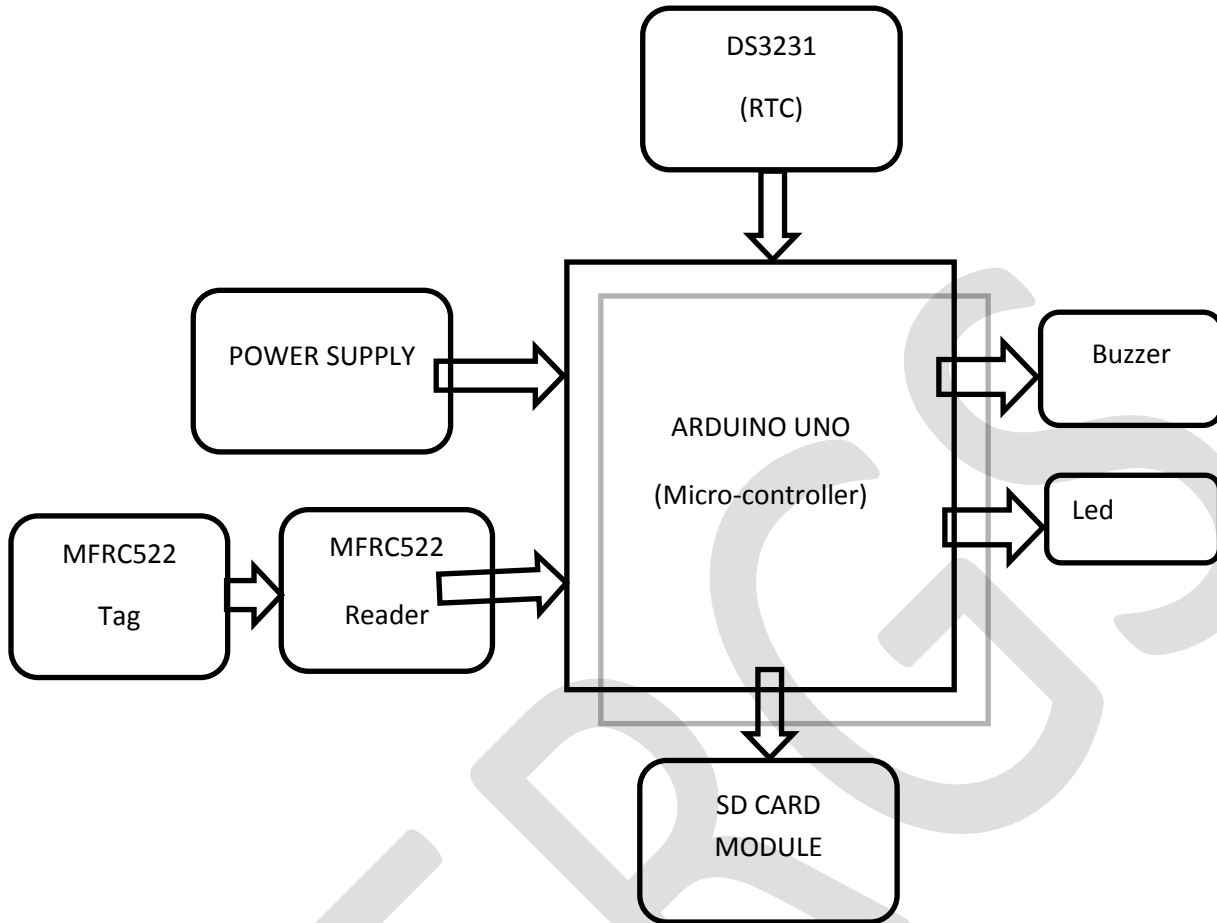

Figure1 Block diagram of an RFID based e-attendance system with storage

### B. Units And Devices

The research is divided into several units which shall be discussed in details

- The Micro-Controller Unit
- The RFID unit
- The Storage Unit
- The Audio Indicator Unit
- The Visual Indicator Unit
- The Timing Unit
- The Power supply unit

### C. The Micro-Controller Unit

The heart of the whole project is the Micro-controller unit. For this project the Arduino Uno Micro-controller was used. It is a low power general purpose micro-controller with good processing speed, small physical dimension, that is durable and cheap.

**Technical Specifications of an Arduino Uno**

Table 1 Specifications of the Arduino

<b>Microcontroller</b>	<b>ATmega328</b>
Operating voltage	5V input voltage (recommended) 7-12V input voltage (limits)
Digital I/O pins	14 (of which 6 are PWM output)
Analog input pins	6
PWM Digital I/O pins	6
Dc current per I/O pin	20Ma
Dc current for 3.3V pin	50Ma
EEPROM	1KB
SRAM	2KB
Clock speed	16MHz
Flash memory	32KB of which 0.5Kb used by bootloader
<b>Length</b>	<b>68.6mm</b>

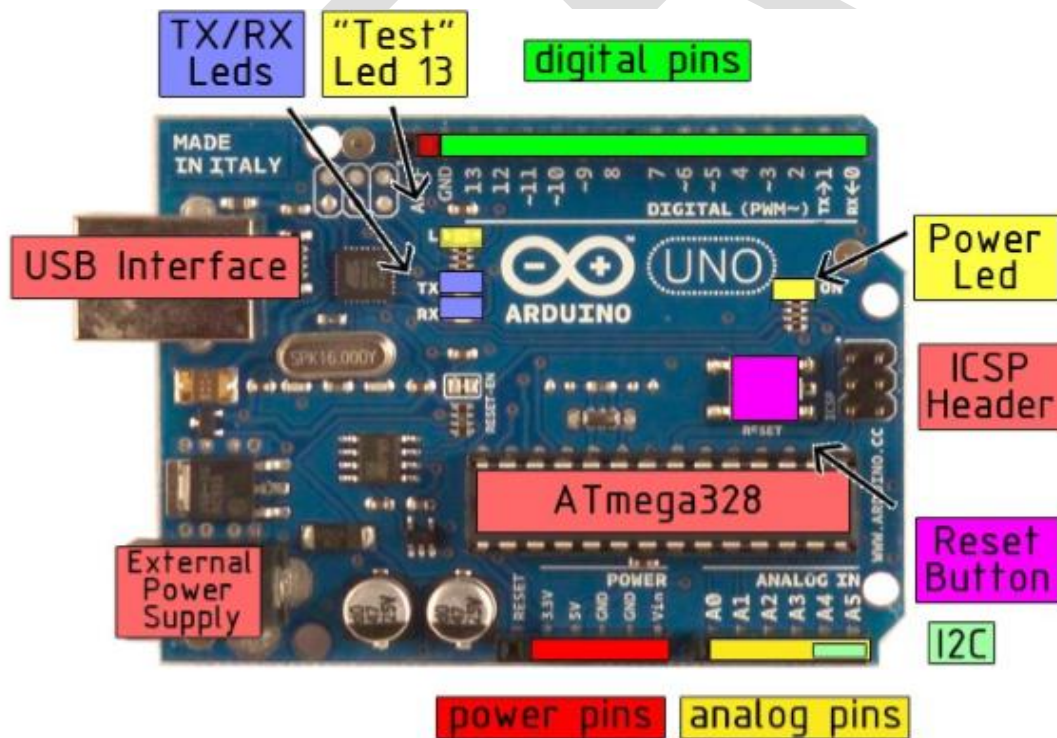

Figure 2: The Arduino Uno Microcontroller

The Arduino Uno Micro-controller is interfaced with the RC522 Reader and DS3231 real-time clock module as inputs and the SD card module and both buzzer and led indicators as outputs. Each pin on the arduino micro-controller can supply 20mA each with 20 pins which gives a total of 400mA maximum current draw from the micro-controller, but it is not recommended to load the micro-controller to its maximum.

### The Storage Unit

The storage unit is the Arduino SD card module, this is a simple solution for transferring data to and from a standard SD card. The pinout is directly compactible with the Arduino Uno micro-controller, which is most convenient for mass data storage and data logging.

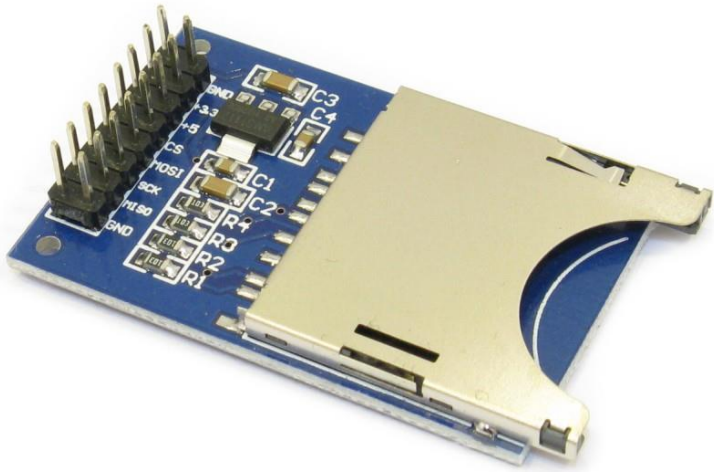

Figure 3: SD Card Module

Since a single log of data from a swiped card is about 20byte

128MB card would be able to log

$128,000,000 \text{ byte} / 20 \text{ bytes} = 6,400,000 \text{ logs}$

### POWER SUPPLY UNIT

The project is powered from a 9 volts battery. This is due to the need for a ease in mobility and compactness of the project. The 9 volts batter can supply upto 600mAh to 1200mAh

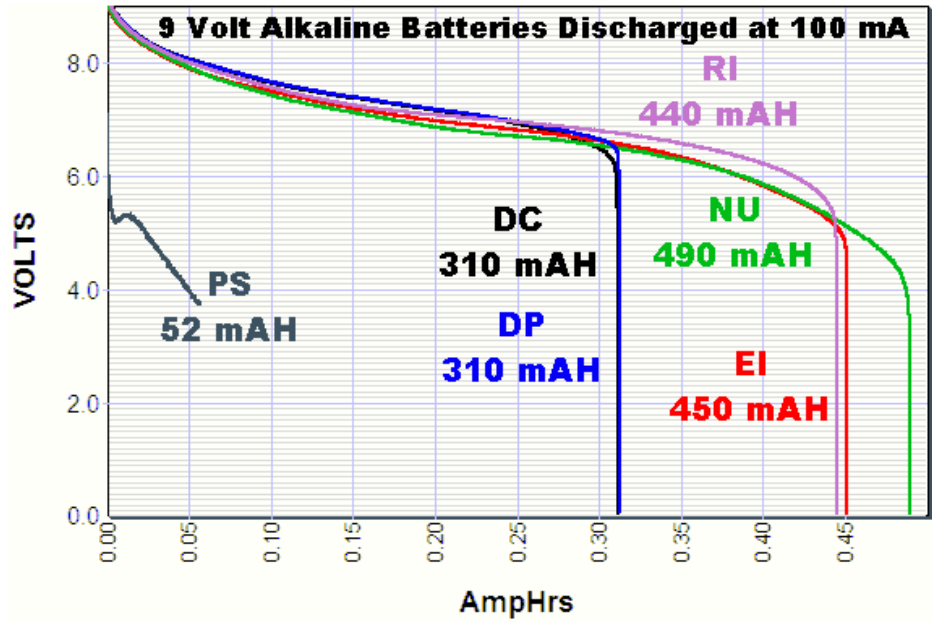

Figure 4: Alkaline batteries discharge rate

#### Circuitry diagram and flow chart

The Circuit diagram for this project is as shown in fig. 3.7, with all voltage supply or vcc symbol referring to appropriate voltage level required by module or unit.

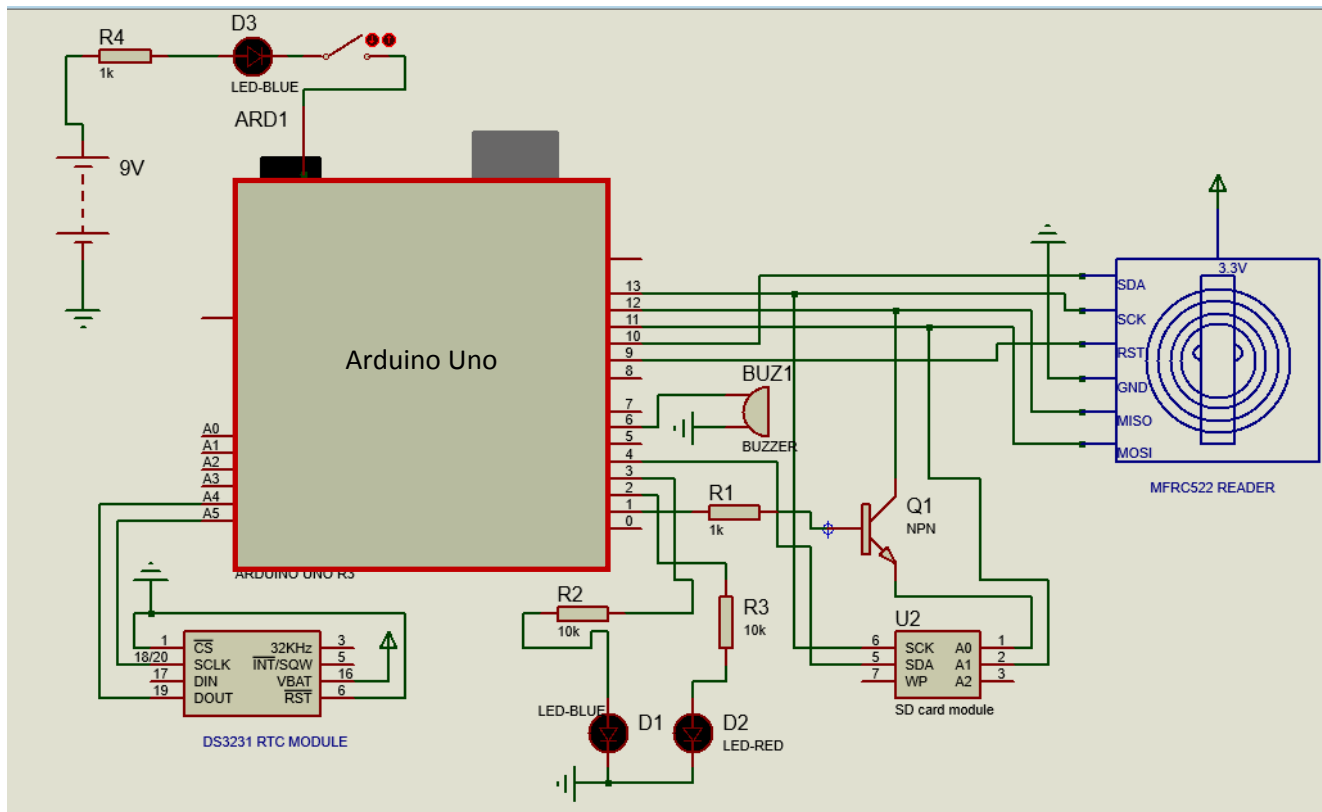

Figure 5: Circuit Diagram for an RFID based e-Attendance Register with Storage

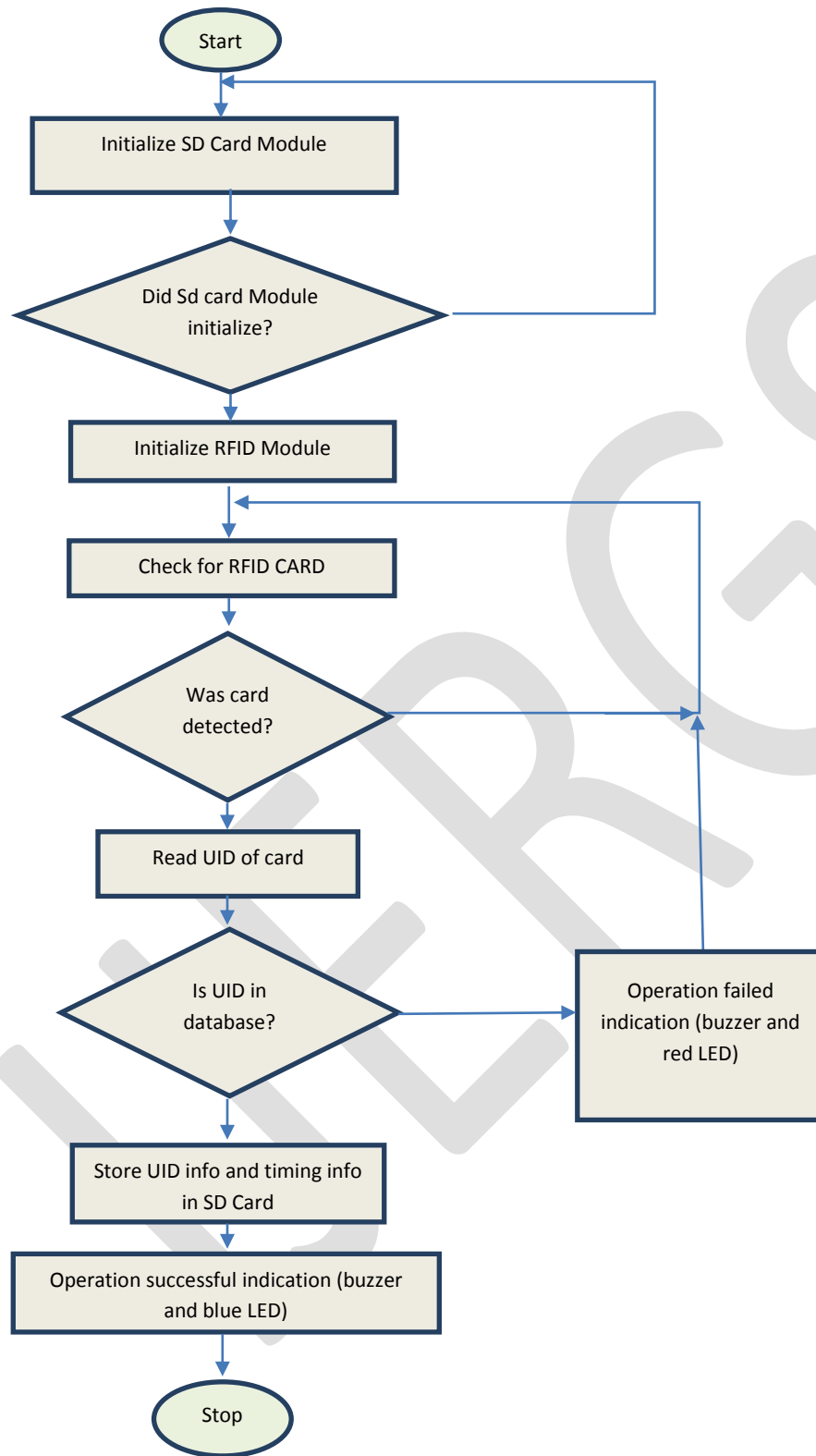

Figure 6 : Flow chart for an RFID based e-Attendance register



#### 4. RESULTS AND DISCUSISION

The performance analysis of an electronic device is very important because it helps the end users of this device to know its efficiency, life span and limitations. It also gives room for further enhancement of the design. However, the performance analysis concerned with this device is limited to components specification/tolerance as slated in the datasheet.

Components specifications/tolerance

**Table 2: Power Analysis**

Module	Current(max)	Voltage	Power(max)
Arduino board	50mA	5v	0.25
MFRC522	26mA	3.3v	0.0858
DS3231 RTC	0.17mA	5v	0.00085
SD card module	100mA	5v	0.5
Piezo Buzzer	30mA	5v	0.15
LEDs	50mA	5v	0.25
<b>TOTAL</b>	Total Amperage 256.17mA		Total wattage 1.237watts

Since the 9v battery can supply up to 1200mA every hour, a single battery would sustain the project for a minimum of 4.6hours. which can be greatly increased based on usage.

Transistor Base resistor calculation for SD card MISO pin

From Datasheet of NPN transistor

$$I_c = 133\text{mA} \quad h_{fe} = 30 \quad I_c/h_{fe} = 4.43\text{mA} \quad V_{be} = 0.95$$

$$R_b = (V_{cc} - V_{be})/I_b = (5 - 0.95)/4.43 = 913 \text{ ohms preferred standard value } 1k$$

**Table 3: System Reliability and Maintenance(DS3231)**

Temperature	Operating: -25°C to 85°C Storage: -40°C(168h) to 85°C (500h)
moisture and corrosion	Operating: 25°C / 95% rel. humidity Non-Operating: 40°C / 93% rel. hum./500h salt water spray: 3% NaCl/35C; 24h acc. MIL-STD Method 1009
Durability	10,000 mating cycles
Bending	10N
Torque	0.10N*m. ±2.5° max
Drop Test	1.5m free fall
Visual Inspection/Shape and Form	No warp age; no mold slim; complete form; no cavities; surface smoothness $\leq$ - 0.1mm/ cm <sup>2</sup> within contour; no cracks; no pollution (oil, dust, etc.)

**Table 4: Reliability and Durability Specifications (DS3231)**

MTBF	1,000,000 hours
Preventive Maintenance	None
Data Reliability	< 1 non-recoverable error in 10 <sup>14</sup> bits read
Endurance	MLC 3,000 -10,000 write/erase cycles TLC 500-1,000 write/erase cycles

**Table 5: Electrical Characteristics (DS3231)**

PARAMETER	SYMBOL	CONDITIONS	MIN	TYP	MAX	UNITS
Supply voltage	$V_{cc}$		2.3	3.3	5.5	V
	$V_{bat}$		2.3	3.0	5.5	V
Logic 1 Input SDA, SCL	$V_{IH}$		$0.7 \times V_{cc}$		$V_{cc} + 0.3$	V
Logic 0 Input SDA, SCL	$V_{IL}$		-0.3		$0.3 \times V_{cc}$	V

**Table 6: Electrical Static Discharge (ESD) requirement (DS3231)**

ESD Protection	Contact Discharge:	$\pm 4\text{KV}$ , Human body model according to IEC61000-4-2.EN55024
	Air Discharge;	$\pm 8\text{KV}$ , Human body model according to IEC61000-4-2.EN55024

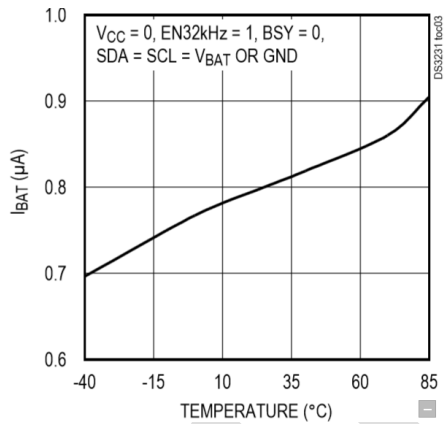

Figure 7: Graph of Supply Current Vs Temperature (DS3231)

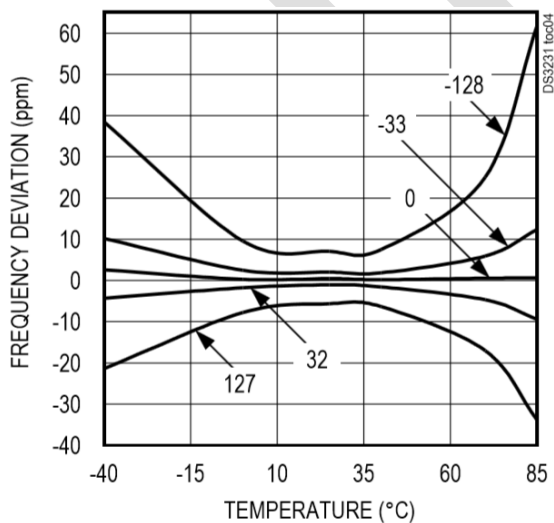

Figure 8: Graph of Frequency Deviation vs Temperature (DS3231)

#### 4. DISCUSSION

More compatible modules can be used for the construction as SD card module and MFRC522 were not really compatible together but was got to work through ingenious means. Also the memory allocation for data collection/logging can be improved on. As FAT16 is the specified format for formatting an SD card lower than 2Gb, while FAT 32 is for formatting an SD card higher than 2Gb. The timing module (DS3231) despite the high-level of accuracy and temperature compensation can be made more accurate for long term purpose of time keeping. As it has a slack of few minutes yearly.

#### Limitations Of This Device

- For high security use, it is recommended to use this device along with other devices to complement it.
- Cards can be stolen or misplaced
- This device is also limited by the amount of memory allocated to it by the administrator for storage of data.
- Alkaline batteries can also be a limitation for prolonged usage.

#### 5. CONCLUSION

This device is very important in today's world because of its application in various areas. It makes life easier which is the purpose of engineering, it makes work more efficient. Its application in non-human attendance taking is very crucial as other biodata collection techniques would fail in this aspect. The device is also cheaper and small which is the current trend in today's technology. Anyone can easily own one for personal use. Lecturers can automatically take their attendance and accurately time students, workers attendance can be much more reliable and it adds class in business environment at such little cost. It is a unique design which is very easy to implement by everyone.

#### REFERENCES:

- [1] Abiona O (2012). Thesis. Lahti University of Applied Sciences in Lahti of Finland;. Adoption possibilities and use of RFID in Nigeria health sector.
- [2] Ajami S, Akbari B, Yarmohammadian MH, Hejazi M, (2012). Isfahan, Iran: Isfahan University of Medical Sciences; Evaluation Usage of "Radio Frequency Identification" in Earthquake's victims tracking Information Management System through viewpoint of Relief Experts.
- [3] Ajami S, Carter MW, (2013). The advantages and disadvantages of Radio Frequency Identification (RFID) in health-care centers; Approach in Emergency Room (ER) Pak J Med Sci.;29:443-8.
- [4] Bates D. W, Gawande A. A, (2003). Improving safety with information technology. N Engl J Med. ;348:2526-34.
- [5] Britton J, (2007). An investigation into the feasibility of locating portable medical devices using radio frequency identification devices and technology. J Med Eng Technol.;31:450-8.
- [6] Chang SI, Ou CS, Ku CY, Yang M, (2008). A study of RFID application impacts on medical safety. Int J Electron Healthc. ;4:1-23.
- [7] Chao CC, Jen WY, Chi YP, Lin B, (2007). Improving patient safety with RFID and mobile technology. Int J Electron Healthc. ;3:175-92.
- [8] Covey, Stephen R, Merrill, Roger A, & Merrill, Rebecca B, (1994). *First things first*. ISBN 0-684-80203-1, published by Free Press.
- [10] Davis N. M, (2004). USA: Masters in Communication Technology and Policy in the faculty of the College of Communication of Ohio University; Application guide for radio frequency identification in electronic medical records. In partial fulfillment of the requirements for the degree.
- [11] Engineering RFID Systems, (2008), IEEE International Conference on RFID, <<http://www.rfidjournalevents.com/live2008/ieee.html>> 4, 16-17.
- [14] Glover B., Bhatt H., (2007). RFID Essentials, O'REILLY, Second edition. 5-14  
Introduction to RFID (accessed 2016). <http://www.centrenational-rfid.com/introduction-to-the-rfid-article-15-gb-ruid-202.html>
- [15] Levinson, Martin H, (n.d). Time-binding time: a history of time-measurement and time-management in America.

- [16] Metras H. (2007). RFID tags for ambient intelligence: present solutions and future challenges, Article. Grenoble. 10.
- [17] Ohashi K, Ota S, Ohno-Machado L, Tanaka H, (2010). Smart medical environment at the point of care: Auto-tracking clinical interventions at the bed side using RFID technology. *Comput Biol Med.* ;40:545–54.
- [18] Yao W, Chu CH, Li Z, (2010). New York: IEEE Institute of Electrical and Electronics Engineers;. The use of RFID in healthcare: Benefits and barriers.

IJERGS