

Innovative Artificial Neural Networks Methodological Advances in ICT Fraud Detection using Bi-Directional ANN

Vijayalakshmi Pasupathy ¹, Yamunadevi S ²

¹ Department of CSE, Panimalar Engineering College, Associate Professor, Chennai

² Department of CSE, Panimalar Engineering College, Assistant Professor, Chennai

Abstract:

Arrangement is one of the data mining issues accepting tremendous thought in the database network. Artificial Neural Network systems (ANNs) have been effectively connected in an extensive variety of machine learning applications, they are anyway regularly viewed as secret elements, i.e., their expectations can't be clarified. Neural systems have risen as cutting edge information mining devices in situations where different procedures may not create attractive prescient models. As the term suggests, neural systems have a naturally roused demonstrating ability, yet are basically factual displaying apparatuses. In this paper, the nuts and bolts of neural system demonstrating, some particular applications, and the way toward actualizing a Bi-directional neural system venture has been proposed. yet in addition protect displaying exactness well.

Keywords: Artificial Neural Networks (ANN), ICT, RNN, FNN

INTRODUCTION

Neural systems speak to a cerebrum similitude for data handling. These models are naturally propelled as opposed to a correct reproduction of how the cerebrum really works. Neural systems have been appeared to be extremely encouraging frameworks in numerous anticipating applications and business characterization applications because of their capacity to "learn" from the information, their nonparametric nature (i.e., no inflexible suppositions), and their capacity to sum up. Neural figuring alludes to an example acknowledgment philosophy for machine learning. The subsequent model from neural figuring is regularly called a counterfeit neural system (ANN) or a neural system. Neural systems have been utilized as a part of numerous business applications for design acknowledgment, estimating, expectation, and characterization. Neural system figuring is a key part of any information mining toolbox.

Utilizations of neural systems possess large amounts of fund, advertising, fabricating, activities, data frameworks, et cetera. Consequently, we give this section to building up a superior comprehension of neural system models, strategies, and applications.

The human mind has confusing abilities for data preparing and critical thinking that advanced PC can't contend with in numerous perspectives. It has been hypothesized that a model

view of this base up proposition, ANN (otherwise called connectionist models, parallel appropriated preparing models, neuromorphic frameworks, or essentially neural systems) have been produced as organically motivated and conceivable models for different errands.

Organic neural systems are made out of numerous enormously interconnected crude natural neurons. Every neuron has axons and dendrites, finger-like projections that empower the neuron to speak with its neighbouring neurons by transmitting and accepting electrical and substance signals.

Pretty much taking after the structure of their partners, ANN are made out of interconnected, straightforward preparing components called counterfeit neurons.

In handling data, the preparing components in an ANN work simultaneously and all in all in a comparative form to organic neurons.

ANN has some attractive attributes like those of natural neural systems, for example, the abilities of learning, self-association, and adaptation to non-critical failure.

2. COUNTERFEIT NEURON
Counterfeit neuron is an essential

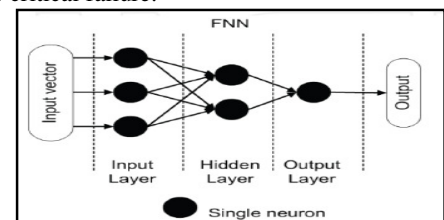

building square of each fake neural system. Its outline and functionalities are gotten from perception of an organic neuron that is essential Building Square of natural neural systems (frameworks) which incorporates the cerebrum, spinal rope and fringe ganglia. Similitude in plan and functionalities can be seen in Fig.1. Where the left half of a figure speaks to an organic neuron with its soma, dendrites and axon and where the correct side of a figure speaks to a fake neuron with its sources of info, weights, exchange capacity, predisposition and yields. If there should arise an occurrence of natural neuron data comes into the neuron through dendrite, soma forms data and passes it on by means of axon. If there should be an occurrence of counterfeit neuron the data comes into the body of a fake neuron by means of sources of info that are weighted (each information can be exclusively duplicated with a weight). The body of a fake neuron at that point wholes the weighted data sources, predisposition and "procedures" the entirety with an exchange work. Toward the end a fake neuron passes the handled data by means of output(s).

Advantage of fake neuron show straightforwardness can be found in its numerical depiction beneath:

$$y(k) = F\left(\sum_{i=0}^m w_i(k).x_i(k)+b\right)$$

Where,

$x_i(k)$ is an input in discrete time k where i goes from 0 to m ,

$w_i(k)$ is weight value in discrete time k where i goes from 0 to m ,

b is bias,

F is a transfer function,

$Y_i(k)$ is output value in discrete time k .

3. SYNTHETIC NEURAL NETWORKS

When consolidating at least two fake neurons we are getting a counterfeit neural system. On the off chance that solitary counterfeit neuron has no helpfulness in taking care of genuine issues the fake neural systems have it. Actually fake neural systems are fit for taking care of complex genuine issues by handling data in their fundamental building squares (fake neurons) in a non-direct, dispersed, parallel and neighbourhood way.

How individual counterfeit neurons are interconnected is called topology, design or chart of a fake neural system.

The way that interconnection should be possible from multiple points of view brings about various conceivable topologies that are isolated into two fundamental classes.

The two topologies; the figure.1 speak to basic feed forward topology (non-cyclic chart) where data streams from contributions to yields in just a single bearing and the figure 1.2 speak to straightforward repetitive topology (semi cyclic diagram) where a portion of the data streams not just one way from contribution to yield yet in addition in inverse course.

Fig.1. FNN Topology of an ANN

When we pick and construct topology of our counterfeit neural system we just completed portion of the assignment before we can utilize this fake neural system for taking care of given issue.

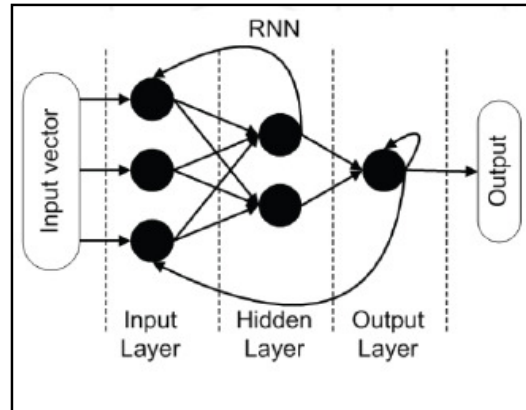

Fig.2. RNN Topology of an ANN

4. NEURAL NETWORK MODELS

4.1 Feed Forward Artificial Neural Networks

Fake neural system with feed-forward topology is called Feed-Forward counterfeit neural system and in that capacity has just a single condition: data must spill out of contribution to yield in just a single bearing with no back-circles.

There are no confinements on number of layers, kind of move work utilized as a part of individual counterfeit neuron or number of associations between individual fake neurons. The least difficult feed-forward counterfeit neural system is a solitary perception that is just fit for learning straight divisible issues.

The straightforward feed-forward fake neural system can prompted moderately long scientific portrayals where counterfeit neural systems' parameters streamlining critical thinking by hand is unfeasible.

$$n_1 = F_1(w_1x_1 + b_1)$$

$$n_2 = F_2(w_2x_2 + b_2)$$

$$n_3 = F_2(w_2x_2 + b_2)$$

$$n_4 = F_3(w_3x_3 + b_3)$$

$$m_1 = F_4(q_1n_1 + q_2n_2 + b_4)$$

$$m_2 = F_5(q_3n_3 + q_4n_4 + b_5)$$

$$y = F_6(r_1m_1 + r_2m_2 + b_6)$$

$$y = F_6 \left[\begin{aligned} & r_1(F_4[q_1F_1[w_1x_1 + b_1] + q_2F_2[w_2x_2 + b_2]] + b_4) + \dots \\ & \dots + r_2(F_5[q_3F_2[w_2x_2 + b_2] + q_4F_3[w_3x_3 + b_3] + b_5]) + b_6 \end{aligned} \right]$$

Fig.3 Feed Forward ANN

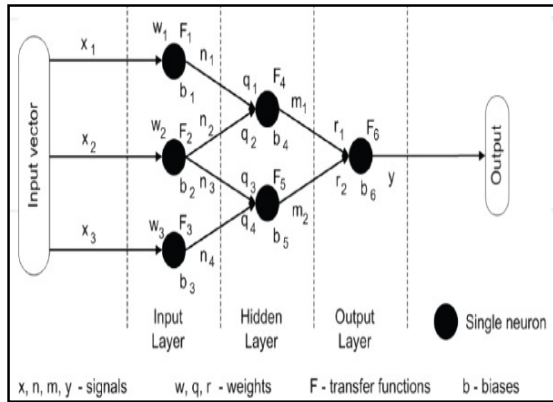

4.2 Recurrent Artificial Neural Networks

Counterfeit neural system with the repetitive topology is called recurrent fake neural system. It is like feed-forward neural system without any constraints in regards to back loops.

In these cases data is never again transmitted just one way yet it is likewise transmitted in reverse. This makes an interior condition of the system which enables it to display dynamic fleeting conduct. Repetitive counterfeit neural systems can utilize their interior memory to process any arrangement of sources of information.

Fig 4. Recurrent ANN

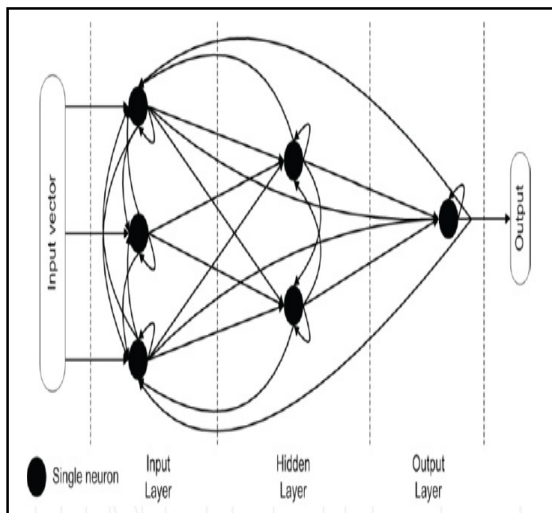

4.3 Hop Field Neural Network

A Hopfield fake neural system is a kind of repetitive counterfeit neural system that is utilized to store at least one stable target vectors. These steady vectors can be seen as recollections that the system reviews when furnished with comparable vectors that go about as a sign to the system memory. These parallel units just take two unique qualities for their states that are dictated by regardless of whether the units' information surpasses their edge. Double units can take either estimations of 1 or - 1, or estimations of 1 or 0.

4.4 Elman and Jordan Artificial Neural Networks

Elman arrange likewise alluded as Simple Recurrent Network is uncommon instance of repetitive fake neural systems. It contrasts from regular two-layer arrangements in that the principal layer has a repetitive association. It is a basic three-layer fake neural system that has back-circle from shrouded layer to enter layer through alleged setting unit (Fig. 4.3.). This kind of fake neural system has

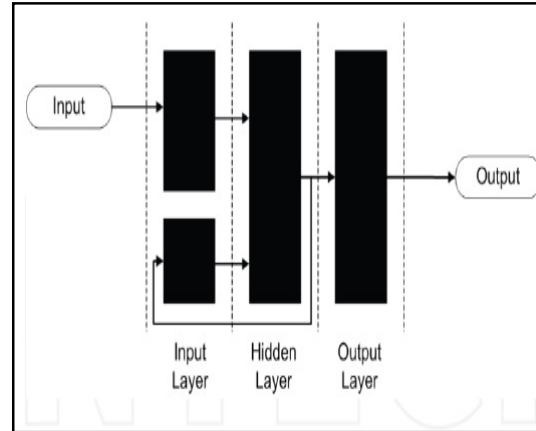

Fig.5 Elman ANN

Memory that enabling it to both recognize and produce time-fluctuating examples.

To store data Elman counterfeit neural system is fit for creating fleeting examples and additionally spatial examples and reacting on them. Jordan arrange (Fig.4.4.) is like Elman organize. The main distinction is that setting units are bolstered from the yield layer rather than the shrouded layer.

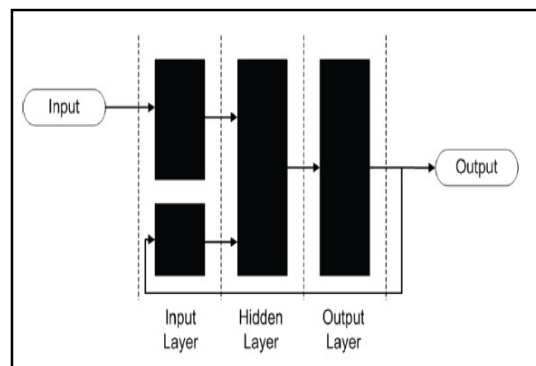

Fig.6 Jordan Network

5. BI-DIRECTIONAL ARTIFICIAL NEURAL NETWORKS (BI-ANN)

Bi-directional counterfeit neural systems (Fig. 7) are intended to foresee complex time arrangement.

They comprise of two individual interconnected counterfeit neural (sub) arranges that performs immediate and converse (bidirectional) change.

Interconnection of fake neural sub systems is done through two unique counterfeit neurons that are equipped for recalling

their inward states. This sort of interconnection amongst future and past estimations of the handled signs increment time arrangement expectation abilities.

In that capacity these counterfeit neural systems foresee future estimations of info information as well as past qualities. That brings requirement for two stage learning; in first stage we show one fake neural sub organize for foreseeing future and in the second stage we educate a second counterfeit neural sub arrange for anticipating past.

6. AN ILLUSTRATIVE EXAMPLE

Utilizing bi-directional fake neural system for ICT misrepresentation recognition

Spread of Information and Communication Technologies brings about advantages for people and society as well as in dangers and increment of Information and Communication Technology cheats.

One of the principle errands for Information and Communication Technology engineers is to avoid potential false fraud fails there is a vital need to detect frauds as soon as possible.

Data and Communication Technology cheats identification depends on various standards. One of such rule is utilization of counterfeit neural systems in the recognition calculations.

The following is a case of how to utilize bi-directional fake neural system for recognizing cell phone misrepresentation. To start with errand is to speak to issue of distinguishing our misrepresentation in the manner in which that can be effectively comprehended by people and machines (PCs). Every individual client or gathering of clients carries on in particular way while utilizing cell phone. By taking in their conduct we can encourage our framework to perceive and anticipate clients' future conduct to a specific level of precision.

With this portrayal we change the conduct expectation errand in time arrangement forecast assignment.

7. EXPERIMENTAL RESULTS

Cell phone misrepresentation identification demonstrate is work out of three modules; input module, fake neural system module and examination module.

Information Module accumulates clients' data about use of cell phone from media transmission framework in three sections. In initial segment it is utilized for social occasion taking in information from which Artificial Neural Network Module learn it-self. In second part Input Module accumulates clients' information for reason for approving the Artificial Neural Network Module and in the third part it gathers clients' information progressively for motivation behind utilizing sent cell phone misrepresentation framework.

Counterfeit Neural Network Module is bidirectional fake neural system that is gaining from accumulated information

and later when the cell phone extortion recognition framework is conveyed constantly predicts time arrangement that speaks to clients' conduct.

Correlation module is utilized for approval of Artificial

Fig. 7 Mobile Fraud Detection Model

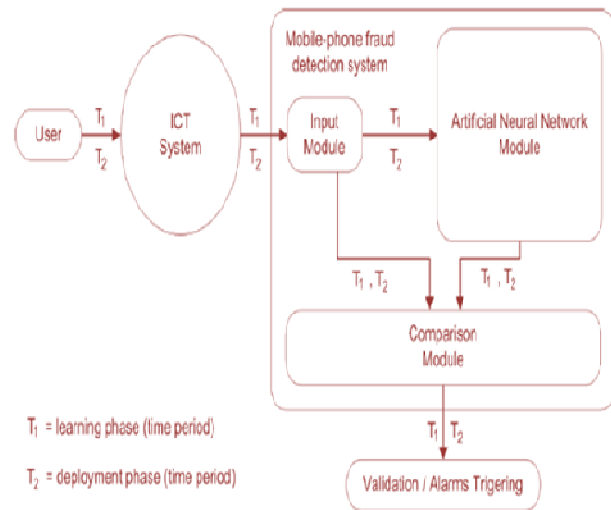

Neural Network Module during the time spent learning and later when the cell phone misrepresentation discovery

Framework is conveyed it is utilized for activating cautions in the event of errors amongst anticipated and genuine accumulated data about clients' conduct.

8. CONCLUSIONS

Fake neural systems are generally spread and utilized as a part of ordinary administrations, items and applications. Albeit present day programming items empower moderately simple taking care of with fake neural systems, their creation, advancement and use, all things considered, circumstances it is important to comprehend hypothesis that stands behind them.

Use of Artificial Neural Networks we portray how to deal with fake neural systems keeping in mind the end goal to make them equipped for taking care of specific issues.

So as to demonstrate what counterfeit neural systems are prepared to do, we gave a short illustration how to utilize bi-directional fake neural system in cell phone misrepresentation location framework.

References

- [1] Bowman, M., Debray, S. K., and Peterson, L. L. 1993. Reasoning about naming systems. .
- [2] Ding, W. and Marchionini, G. 1997 A Study on Video Browsing Strategies. Technical Report. University of Maryland at College Park.

- [3] Fröhlich, B. and Plate, J. 2000. The cubic mouse: a new device for three-dimensional input. In Proceedings of the SIGCHI Conference on Human Factors in Computing Systems
- [4] Tavel, P. 2007 Modeling and Simulation Design. AK Peters Ltd.
- [5] Sannella, M. J. 1994 Constraint Satisfaction and Debugging for Interactive User Interfaces. Doctoral Thesis. UMI Order Number: UMI Order No. GAX95-09398., University of Washington.
- [6] Forman, G. 2003. An extensive empirical study of feature selection metrics for text classification. *J. Mach. Learn. Res.* 3 (Mar. 2003), 1289-1305.
- [7] Brown, L. D., Hua, H., and Gao, C. 2003. A widget framework for augmented interaction in SCAPE.
- [8] Y.T. Yu, M.F. Lau, "A comparison of MC/DC, MUMCUT and several other coverage criteria for logical decisions", *Journal of Systems and Software*, 2005, in press.
- [9] Spector, A. Z. 1989. Achieving application requirements. In *Distributed Systems*, S. Mullende
- [10] V. Blavette, Application of Intelligent Techniques to Telecommunication Fraud Detection, <http://www.eurescom.eu/public/projects/p1000-series/P1007/default.asp>, May 2001.
- [11] h71028.www7.hp.com/ERC/downloads/4AA0-8765ENW.pdf, HP Fraud Management Systems (FMS) Solution, June 2005.
- [12] R.J. Bolton and D.J. Hand, "Statistical Fraud Detection: A Review," *Statistical Science*, vol. 3, 2002, pp. 235-255.
- [13] J. Hollmen, User Profiling and Classification for Fraud Detection in Mobile Communication Networks, PhD thesis, Helsinki University of Technology, Department of Cognitive and Computer Science and Engineering, Espoo, 2000.
- [14] T. Fawcett and F. Provost, "Adaptive Fraud Detection," *Datamining and Knowledge Discovery*, vol. 1, 1997, pp. 1-28.
- [15] http://www.theregister.co.uk/2005/12/19/terror_phone_clone_scam/, Dec. 2005.
- [16] H. Wakuya, K. Shida, and J.M. Zurada, "Time series prediction by a neural network model based on bi-directional computation style: A study on generalization performance with the computergenerated time series 'Data Set D'," *Systems and Computers in Japan*, vol. 34, no. 10, 2003, pp. 64-75.
- [17] H. Wakuya and K. Shida, "Bi-directionalization of Neural Computing Architecture for Time Series Prediction. III: Application to Laser Intensity Time Record 'Data Set A'," *Proc. INNS-IEEE, Int'l Joint Conf. on Neural Networks*, 2001.
- [18] H. Wakuya, K. Shida, and J.M. Zurada, "Bi-directionalization of Neural Computing Architecture for Time Series Prediction: Application to Computer Generated Series 'Data Set D'," *6th Int'l Conf. Soft Computing*, 2000.
- [19] H. Wakuya and J.M. Zurada, "Bi-directional Computing Architecture for time Series Prediction," *Neural Networks*, vol. 14, no. 9, 2001, pp. 1307-1321.