

A WIRELESS PHONE CHARGING SYSTEM USING RADIO FREQUENCY ENERGY HARVESTING

I. Gana, M. Abdulkadir* and Mala U.M. Bakura

*(Department of Electrical and Electronics Engineering, Faculty of Engineering,
University of Maiduguri, Nigeria)*

Corresponding author's e-mail address: abdulkadirmusa@unimaid.edu.ng

Abstract

A wireless phone charging system using Radio Frequency (RF) energy harvesting is presented in this paper. Battery size and extension of charge duration offer great challenge in mobile devices and the fact that one has to always connect it to the mains for charging. The research seeks to employ the RF received by its antenna to recharge mobile end devices. This study determined the suitable frequency for power transmission and chooses an efficient microstrip patch antenna which has a gain of 3.762dB, directivity of 5.906dB, and a power density of 7.358dBW/m². A 7stage voltage doubler was employed to harvest the 3.75V dc from the RF which is suitable to charge a mobile phone. The antenna was designed and simulated using Computer Simulation Technology (CST) studio suite while the RF to DC converter was design and simulated using Intelligent Schematic Input System (ISIS) Proteus.

Key words: RF Energy Harvesting, Microstrip patch antenna, Frequency, RF to DC conversion

1. Introduction

Mobile phone is a device in which one can communicate with another basically either by calling/receiving telephone call over a radio link. When the mobile phone was first introduced, it was huge in size comparing to today's standards. The reasons for that can be mainly characterized by three factors which are; the circuits were built using discrete components, large antenna, and the battery had to be large as well (Harrist, 2004). In recent years, technology has allowed the mobile phone to be portable not only in the size because ICs are used, but also the batteries and antennas used. Many researches had been done in order to optimize the mobile phone to further shrink them to suite the customer's needs. However, as technology advanced, our mobile phones becomes smaller, easier to carry and use. The main problem now is the charge duration; charging system and size of batteries necessitate carrying extra battery, charger or power bank. But the easiest way is to harvest the energy that is being transmitted in RF form and use it as a charging source. This could potentially be used to power other devices. The idea of power transmission using radio waves has attracted research interest recently. Basically, power transmission using radio waves is described using three-steps as follows;

- i. DC power is converted to RF power.
- ii. This RF power is transmitted with the aid of antenna through space over a distant point.
- iii. The power collected by the receiving antenna is converted back to DC power to charge the mobile phone battery (Brown, 1984).

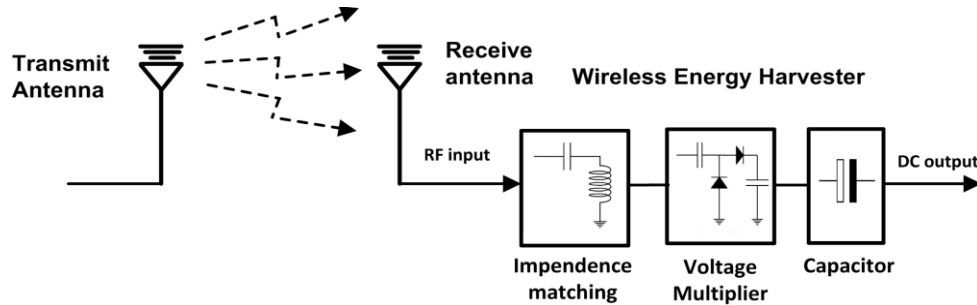

Figure 1: Ambient RF energy harvesting network (Prusayon *et al.*, 2012)

The greatest challenge is in determining the suitable frequency for power transmission. These sections of this frequency band is very important aspects that have to be considered when designing the RF energy harvesting system. Generally, four frequencies are mainly used in today's industry for different applications. The frequencies are 125 KHz, 13.56 MHz, 868 MHz and 2.4GHz. These frequencies are allowed by the European Telecommunications Standards Institute (ETSI) to be used without permission (Christian *et al.*, 2014). The main aim of this paper is to harvest energy from the RF signal round, therefore is need for efficient antenna, characterized by the small size and a suitable RF power converter to recharge the mobile phone battery at receiving stage. Another factor to be considered is the matching of antenna and the circuits impedances. When there is mismatch, some of the power will be reflected back from antenna to the source and will be lost in form of heat and damages the system as reported in (Christian *et al.*, 2014).

2. Materials and Methods

To achieve this charging system; a microstrip antenna and RF to DC converter is required. Therefore, the design of this microstrip antenna and the RF to DC converter is discuss in this section.

2.1 Design Analysis of the Microstrip Patch Antenna

There are three essential parameters for the design of a rectangular Microstrip Patch Antenna which are:

- i. Frequency of Operation: The resonant frequency of the antenna must be selected appropriately. 2400MHz falls in one of the Industrial-Scientific-Medical (ISM) RF bands, which are made available by the Federal Communications Commission for Bluetooth, WLAN, low power, short distance experimentation and other applications without permission (Harrist, 2004). Hence the resonant frequency selected for design is 2.4 GHz.
 - ii. Dielectric constant of the substrate (ϵ_r): The dielectric material selected for this design is Styrofoam which has a dielectric constant of 1.03. A substrate dielectric constant should consider for selection because the dielectric constant affects the dimensions of the antenna. (Ashish *et al.*, 2011), (Constantine, 2009) different dielectric materials are summarized in (NehaChavda *et al.*, 2014).
 - iii. Height of dielectric substrate (h): For the microstrip patch antenna which are used in cellular phones or other hand held devices it is essential that the antenna is not bulky. Hence, the height of the dielectric substrate should be small; effect of height is discussed in (Constantine, 2009). Here Styrofoam substrate of standard height 12 mm is selected
- Transmission line model will be used to design the antenna. The wavelength (λ)

$$\lambda = c/f_0 \quad (1)$$

Where: $c = 3 \times 10^8$ and $f_0 = 2.4$ GHz, substituting the value of c and f_0 in equation (1) yield $\lambda = 0.125$ m = 125 mm

The width (W) of the microstrip patch antenna is given by equation (2)

$$W = \frac{c}{2fr} \left(\frac{\epsilon_r + 1}{2} \right)^{-0.5} \quad (2)$$

Where $c =$ speed of light, $\epsilon_r =$ dielectric constant

Substituting $\epsilon_r = 1.03$, in equation (2) yielded $W=62.04$ mm.

Equation (3) describes the effective dielectric constant

$$\epsilon_{reff} = \frac{\epsilon_r + 1}{2} + \frac{\epsilon_r - 1}{2} \left[1 + 12 \frac{h}{W} \right]^{-0.5} \quad (3)$$

Where $W =$ width of the antenna, $h =$ height of dielectric substrate

Substituting $h = 12$ mm and $W = 62.04$ mm, in equation (3) yielded $\epsilon_{reff} = 1.023$

Figure1 is a top view of a microstrip patch antenna showing the feed point, patch and the ground plane

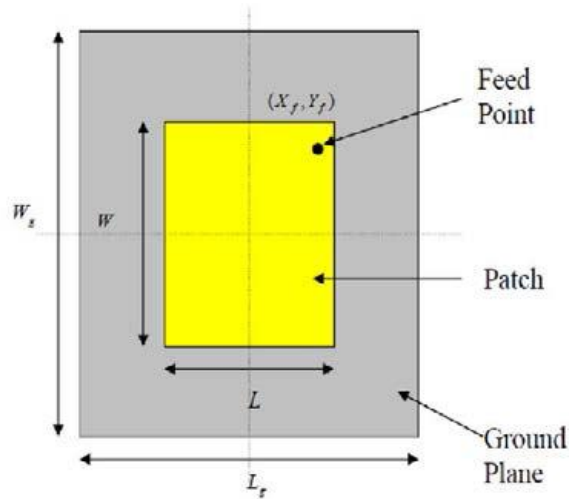

Figure 1: Top view of design procedure microstrip patch antenna (Nakar, 2004)

Equation (4) gives the effective length

$$L_{reff} = \frac{c}{2fr\sqrt{\epsilon_{reff}}} \quad (4)$$

Substituting $\epsilon_{reff} = 1.023$, in equation (4) yield $L_{reff} = 61.79$ mm

Equation (5) gives the length extension of antenna.

$$\Delta L = 0.412h \frac{(\epsilon_{reff} + 3) \left(\frac{W}{h} + 0.264 \right)}{(\epsilon_{reff} - 1) \left(\frac{W}{h} + 0.8 \right)} \quad (5)$$

Substituting $L_{reff} = 61.79$ mm, in equation (5) yields $\Delta L = 7.78$ mm

Equation (6) gives the actual length of patch

$$L = L_{eff} - 2\Delta L \quad (6)$$

Substituting $L_{eff} = 61.79$ mm and $\Delta L = 7.78$ mm, in equation (6) yield $L = 46.23$ mm

The transmission line model is applicable to infinite ground planes only. However, for practical considerations, it is essential to have a finite ground plane. Finite and infinite ground plane can

be obtained if the size of the ground plane is greater than the patch dimensions by approximately six times the substrate thickness all around the periphery (Nakar, 2004). Hence, for this design, the ground plane dimensions would be given as:

$$L_{(g)} = 6h + L \quad (7)$$

Substituting $h = 12\text{mm}$ and $L = 46.23\text{mm}$, in equation (7) yields $L_{(g)} = 118.23\text{ mm}$

$$W_{(g)} = 6h + W \quad (8)$$

Substituting $h = 12\text{mm}$ and $W = 134.04\text{mm}$, in equation (8) yields $W_{(g)} = 134.04\text{ mm}$

The typical impedance at the edge of a resonant rectangular patch can be approximated by equation (9)

$$Z_{in} = 90 \frac{\epsilon_r^2}{\epsilon_r + 1} \left(\frac{L}{W} \right)^2 \quad (9)$$

Yield $Z_{in} = 1776 \Omega$, therefore the characteristic impedance can be obtain using equation (10)

$$Z_o = \sqrt{(50 \times Z_{in})} \quad (10)$$

The characteristic impedance of the transition section should be 297Ω .

3. Results and Discussion

Considering design parameters as obtained in the antenna design, the antenna was simulated using Computer Simulation Technology (CST) Studio Suite Software and the results obtained are discussed in this section. The most important parameters in the design of any antenna are the gain and return loss. However, there are other parameters which played a good rule such as radiation efficiency, directivity of the antenna, beam width which the dot product of efficiency and directivity (Nakar, 2004) and the antenna band width. In this section these three parameters will be illustrated with the aid of 3D and polar views obtained from the CST Studio Suite Software simulation result.

The gain of an antenna generally describes the ratio of the power radiated from the antenna in a target direction to the power radiated from an isotropic antenna. An isotropic antenna is an antenna that radiates power equally in all direction hence the gain of an isotropic antenna is unity. The gain of the Microstrip patch antenna obtained at port 1 is 3.762 dB at the operating frequency of 2.4 GHz as shown in Figures 2 and 3, which shows the limitation of Microstrip patch antenna of having low gain, therefore, the distance between the RF source and the Microstrip patch antenna should not far so as to increase the power receive.

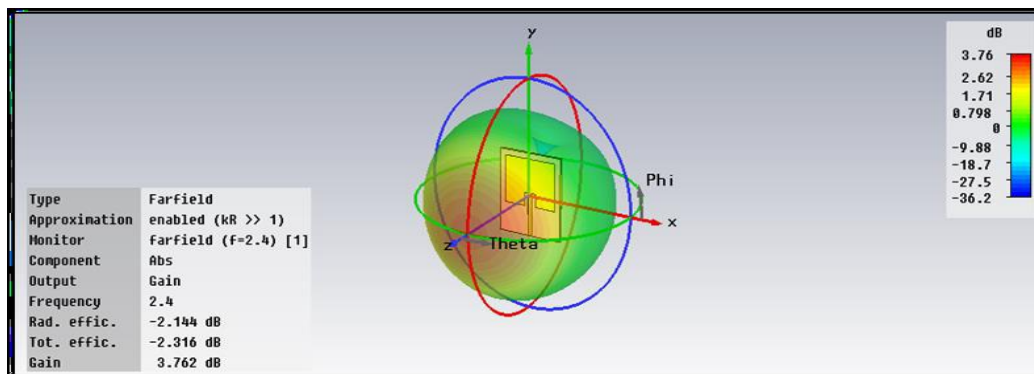

Figure 2: D view of the gain of Microstrip patch antenna at 2.4GHz

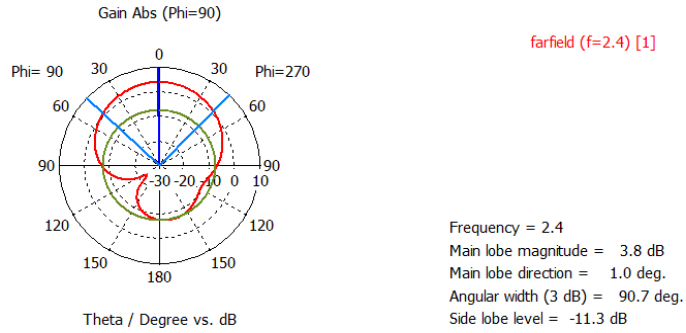

Figure 3: Polar Plot of the gain of the proposed antenna

The directivity of the antenna is obtained as 5.906 dB, which is given by the 3D view obtained from the far field option as shown in Figure 4.

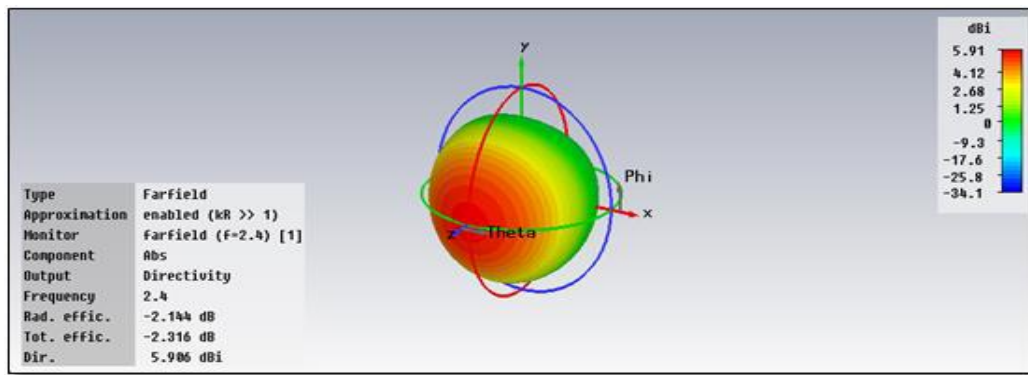

Figure 4: Directivity of the proposed antenna

Power density is another parameter that can be obtained from far field option, it describes the power sent or received by the antenna over a square meter. The power density at any distance from a unity gain antenna can be defined as the transmitted power divided by the surface area of sphere, which is $4\pi R^2$, as it can be observed from the sphere radius; the surface area will be increased by square of radius, while the power density would be decrease by same square radius factor. The power density of the proposed antenna is -7.358 dBW/m^2 as illustrated in Figure 5, which implies the limitation of power handled by Microstrip antenna.

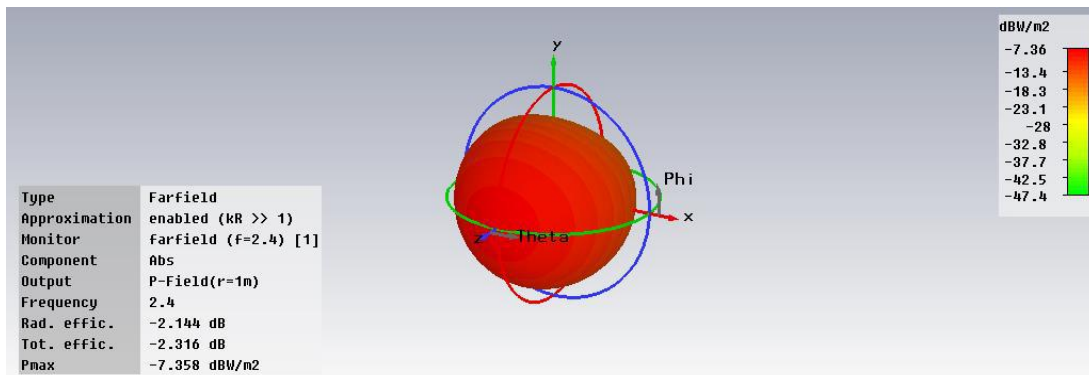

Figure 5: Power density of the proposed antenna

3.1 Return Loss

Return Loss of the antenna gives a measurement of how effective the antenna is in terms of power delivery from transmission line to a load (i.e. the antenna). If the power incident is P_{in} , and the power reflected to the source is P_{out} , then the return loss is given by equation (11).

$$R_L = 10 \log \frac{P_{in}}{P_{out}} \text{ dB} \quad (11)$$

Figure 6 shows the graph of S – Parameter in dB against frequency in GHz obtained from CST simulation software.

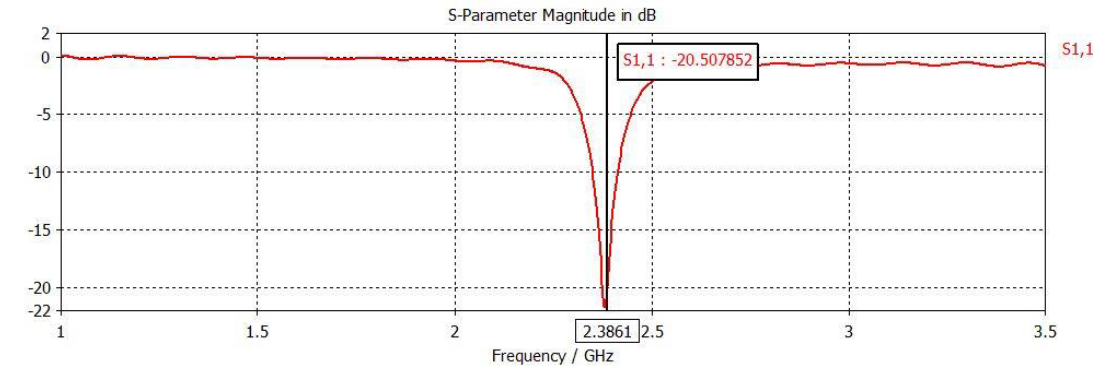

Figure 6: Return Loss S_{11} results of simulation

S-parameter simply refers to RF voltage output versus voltage input. Basically it is the magnitude of the reflection coefficient that depends on the antenna impedance and the impedance of Vector Network Analyzer (VNA) typically 50 ohms. S-parameter is complex, since it has magnitude and angle. Besides these magnitude and angle changed by the network as shown in the graph in fig 7, the S_{11} passes -10 dB at the operating frequency of 2.4 GHz which means the power reflected to the source represents 10% only while 90% of the launched power will be radiated by the antenna. This makes it suitable for this application.

3.2 RF to DC Conversion

To convert the RF signal harvested from the antenna to DC power suitable to charge a mobile phone, a voltage multiplier circuit is required. The circuit is also called a voltage doubler because in theory, the voltage that is arrived on the output is approximately twice that at the input. The circuit consists of two sections; each comprises a diode and a capacitor for rectification. The RF input signal is rectified in the positive half of the input cycle, followed by the negative half of the input cycle. But, the voltage stored on the input capacitor during one half cycle is transferred to the output capacitor during the next half cycle of the input signal (Harrist, 2004). Thus, the voltage on output capacitor is roughly two times the peak voltage of the RF source minus the turn on voltage of the diode (threshold voltage).

The most interesting feature of this circuit is that when these stages are connected in series. This method behaves akin to the principle of stacking batteries in series to get more voltage at the output. The output of the first stage is not exactly pure DC voltage and it is basically an AC signal with a DC offset voltage. This is equivalent to a DC signal superimposed by ripple content. Due to this distinctive feature, succeeding stages in the circuit can get more voltage than the preceding stages. If a second stage is added on top of the first multiplier circuit, the only waveform that the second stage receives is the noise of the first stage. This noise is then doubled and added to the DC voltage of the first stage. Therefore, the more stages that are added,

theoretically, more voltage will come from the system regardless of the input. Each independent stage with its dedicated voltage doubler circuit can be seen as a single battery with open circuit output voltage V_0 , internal resistance R_0 with load resistance R_L , the output voltage, V_{out} is expressed as in Equation (12).

$$V_{out} = \frac{V_0}{R_0 + R_L} R_L \quad (12)$$

When n number of these circuits are put in series and connected to a load of R_L in Equation (12) the output voltage V_{out} obtained is given by this change in RC value will make the time constant longer which in turn retains the multiplication effect of two in this design of seven stage voltage doubler.

$$V_{out} = \frac{nV_0}{nR_0 + R_L} = V_0 \frac{1}{\frac{R_0}{R_L} + \frac{1}{n}} \quad (13)$$

The number of stages in the system has the greatest effect on the DC output voltage, as shown from Equations (12) and (13). It is inferred that the output voltage V_{out} is determined by the addition of R_0/R_L and $1/n$, if V_0 is fixed.

The power received by the antenna which will be feed to this circuit can be explained by Friis power transmission equation given in (Poazar, 2009) as:

$$P_r = P_t \frac{G_t G_r \lambda^2}{(4\pi R)^2} \quad (14)$$

where: P_r , P_t , G_t , G_r , λ and R are the Received power, transmitted power, transmitted antenna gain, received antenna gain, wavelength and distance between the transmitting and receiving antenna respectively.

The RF to DC conversion circuit was design and simulated using ISIS Proteus. It consists of a 7-stage voltage doubler circuit. Schottky diode was used because of the low voltage drop across it and the stage capacitors are varied until the output voltage is significantly high enough to charge a mobile phone. The designed circuit for the RF to DC converter is shown in figure 8.

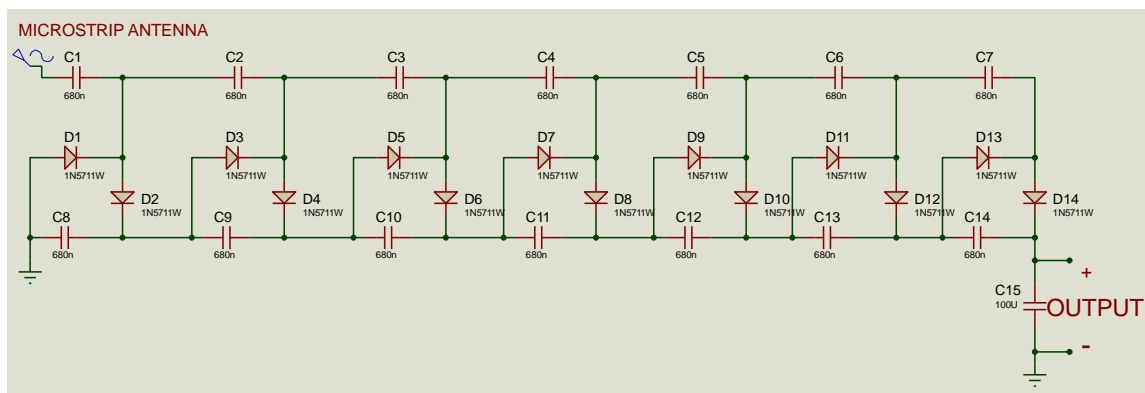

Figure 7: Seven Stages RF to DC Circuit

The simulation was performed and the output of the RF to DC converter was measured using a DC voltmeter and oscilloscope. The voltmeter was connected across the output of the RF to DC converter and the voltage output is measured directly from the meter. In the case of the oscilloscope; the positive output terminal of the circuit was connected to channel A of a oscilloscope and the negative terminal to the channel C which serves as the ground and the

voltage setting of the oscilloscope was set to 0.5V/div (i.e. 0.5volt per division). Therefore, the voltage output is calculated as;

$$V_{out} = N \times x \quad (15)$$

Where $N = \text{Number of boxes}$, $x = \text{voltage setting}$

The test setup was captured from the software as in Figure 9 and 10.

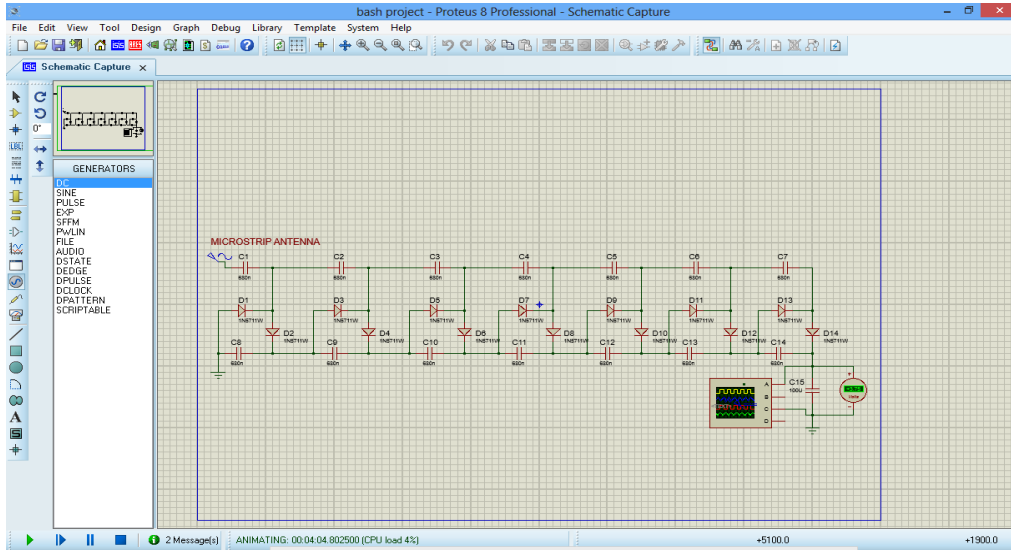

Figure 8: Test Setup

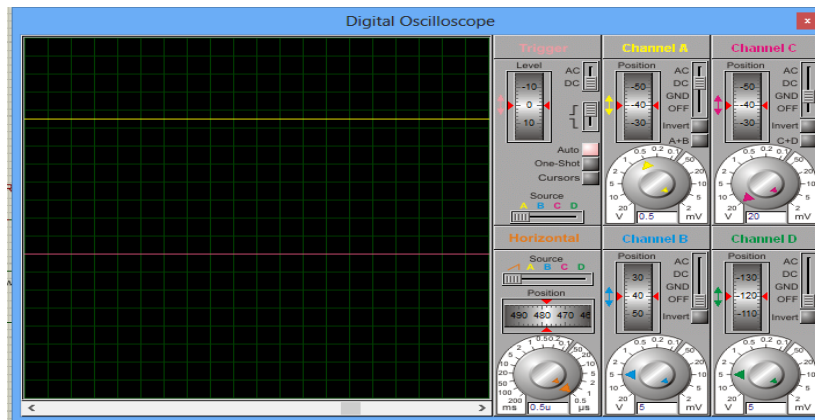

Figure 9: Oscilloscope showing the DC output

The voltmeter reads the output voltage directly as 3.75 Volt. The number of boxes obtained is 7.5 as shown in Figure 9, which the voltage setting as 0.5V/div the output is obtained from equation (15) as;

$$V_{out} = 7.5 \times 0.5 = 3.75 V$$

4. Conclusion

This paper presents a step towards a goal that would have profound ramifications on the cellular phone industry and the portable electronic device as a whole by achieving a wireless charging system. The work achieved a microstrip patch antenna, design and simulated using CST studio suite, which have the following parameters frequency = 2.4GHz, wavelength = 125mm, gain =

3.762dB, directivity = 5.906dB, power density = 7.358dBW/m². The RF to DC conversion circuit was designed which gave an output voltage of 3.75V. The sole aim of this paper is achieved since the voltage earned is significantly enough to charge mobile phone. However

References

Ashish, K. 2011. Rectangular Microstrip Patch Antenna Loaded With Double Orthogonal Crossed Slits in Ground Plane. International Journal of Advanced Technology & Engineering Research pp 44 - 59

Brown, W. C. 1984. The history of power transmission by radio waves. Microwave Theory and Techniques, IEEE Transactions on 32(9): pp 1230-1242.

Christian, M. 2014. Wireless and Battery-less Sensor Using RF Energy Harvesting. European Telemetry and Test Conference on 34(1); pp 8 - 13

Constantine AB, 2009, Antenna theory analysis and design, 3rd edition, John Wiley and sons, Inc, pp 77 – 100

Harrist, DW. 2004. Wireless battery charging system using radio frequency energy harvesting, University of Pittsburgh. Pp 7 - 19

Nakar, PS. 2004. "Design of a compact Microstrip patch antenna for use in wireless/cellular devices." Florida state university libraries pp 34

NehaChavda, 2014. Designing of Microstrip Patch Antenna For 3G-WCDMA Applications. Parul institute of engineering and technology pp10 – 15

Pozar, DM. 2009. Microwave Engineering, 4th edition John Wiley & Sons. Pp 95 - 157

Prusayon, N. 2012. Design optimization and implementation for RF energy harvesting circuits. IEEE. Journal of Emerging and Selected Topics in Circuits and Systems, 2 (1) pp 24 - 33