

# IMPLEMENTATION OF PERTURB AND OBSERVE MPPT ON PV SYSTEM USING BUCK-BOOST CONVERTERS

Srinivas.Sampathirao 1, B.Gayatri<sup>2</sup>

1P.G.Student, Dept. of EEE, Srisivani institute of technology, Chilakapalem, Andhrapradesh

2 AssistanProfessor, Dept. of EEE, Srisivani institute of technology, Chilakapalem, Andhrapradesh

**ABSTRACT :** The Maximum Power Point Tracking (MPPT) is a technique used in power electronic circuits to extract maximum energy from the Photovoltaic (PV) Systems. In the recent decades, photovoltaic power generation has become more important due its many benefits such as needs a few maintenance and environment advantages and fuel free. However, there are two major barriers for the use of PV systems, low energy conversion efficiency and high initial cost. One of the method to improve the energy efficiency is to work PV system always at its maximum power point. So far, many researches are conducted and many papers were published and suggested different methods for extracting maximum power point. This paper presents in details implementation of Perturb and Observe MPPT using buck ,boost and buck-boost Converters. Some results such as current, voltage and output power for each various combination have been recorded. The simulation has been accomplished in software of MATLAB Math works.

**INDEX TERMS:** Maximum Power Point Tracking, Perturb and Observe, DC-DC Converters, Photovoltaic System

## INTRODUCTION

The usage of modern efficient photovoltaic solar cells (PVSCs) has featured as an masterminding alternative of energy conservation, renewable power and demand-side management. Due to their initial high expensive, PVSCs have not yet been an exactly a tempting alternative for electrical usage who are able to purchase less expensive electrical energy from the utility grid. However ,they have been used widely for air conditioning in remote , water pumping and isolated or remote areas where utility power is not available or is high costly to transport. Although PVSC prices have decreased considerably during the last years due to new developments in the film technology and manufacturing process . The harnessing of solar energy using PV modules comes with its own problems that arise from the change in insulation conditions. Those changes in insulation conditions strongly influence the efficiency and output power of the PV modules. A great deal of research has been accomplished to improve the efficiency of the photovoltaic system. Several methods to track the maximum power point of a PV module have been suggested to solve the problem of efficiency and products using these methods have been made and now commercially available for consumers

As the market is now flooded with species of these MPPT that are intentional to improve the efficiency of PV modules under different isolation conditions it is not known how many of these can actually provide on their promise under a diversity of field conditions. This research then seems at how a different kind of converter affects the output power of the module and also achieve if the MPPT that are said to be highly efficient and do track the true maximum power point under the different conditions. A maximum power point tracker is used for obtaining the maximum power from the solar PV module and conversion to the load. A non isolated DC-DC converter (step up/ step down) offers the purpose of conversion maximum power to the load. A DC-DC converter acts as an interface between the load and the module. By varying the ratio of duty cycle the impedance of load as it appears by the source is varied and matched at the peak power point with the source so as to conversion the maximum power .

Therefore maximum power point tracker methods are required to maintain the PV array' s working at its MPP. Many MPPT methods have been suggested in the literature ; example are the Perturb and Observe (P&O) methods, Incremental Conductance (IC) methods and constant voltage methods.. etc. In this paper the most popular of MPPT technique (Perturb and Observe (P&O) method, Buck and Buck- Boost DC-DC converters will involve in Implementation study figure 1. Some results such as current, voltage and output power for each various combination have been discussed. The MPPT technique will be implemented, by using Matlab tool Simulink, considering the variant of circuit combination.

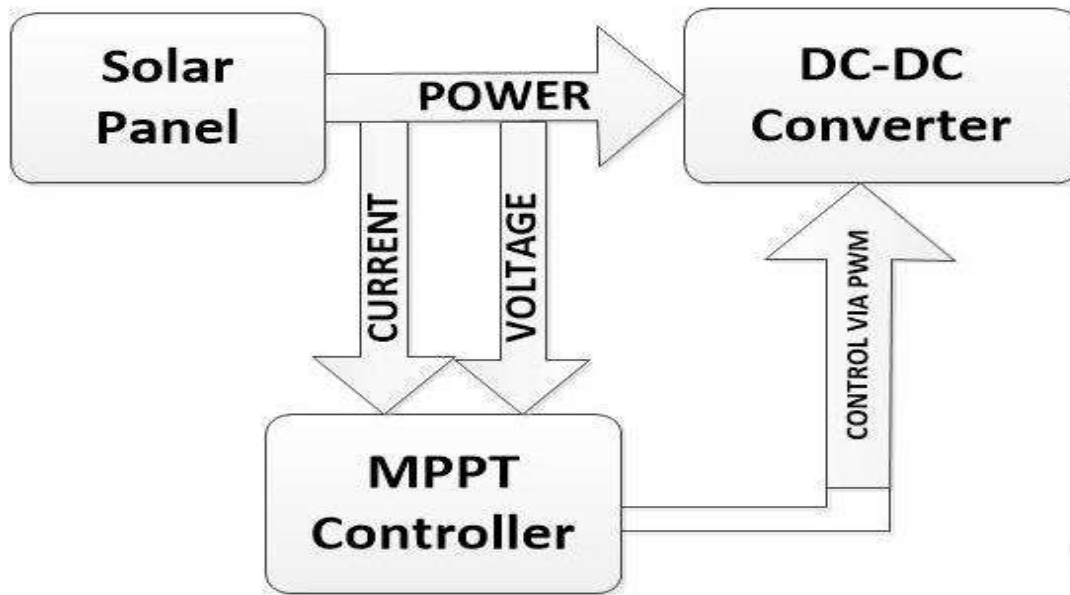

## 2. Photovoltaic Cell

Photovoltaic generators are neither fixed current sources nor voltage sources but can be approximated as current generators with dependant voltage sources. During darkness, the solar cell is not an active device. It produces neither a current nor a voltage. A solar panel cell essential is a p-n semiconductor junction. When exposed to the light, a current is generated (DC current). The generated current change linearly with the solar irradiance. Figure 2 show the equivalent electrical circuit of an ideal solar cell.

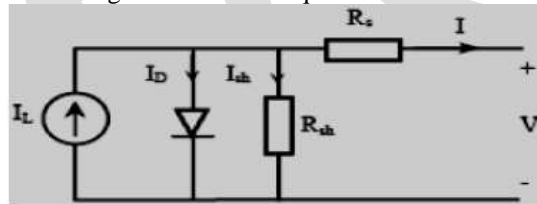

Figure 2. Equivalent circuit of a solar cell

The I-V characteristics of the solar cell circuit can be sets by the following equations . The current through diode is given by:

$$I_D = I_O [\exp (q (V + I R_S)/KT)) - 1] \quad (1)$$

While, the solar cell output current:

$$I = I_L - I_D - I_{sh} \quad (2)$$

$$I = I_L - I_O [\exp (q(V + I R_S)/KT)) - 1] - (V + I R_S) / R_{sh} \quad (3)$$

Where

I : Solar cell current (A)

$I_L$  : Light generated current (A)

$I_O$  : Diode saturation current (A)

q : Electron charge ( $1.6 \times 10^{-19}$  C)

K : Boltzman constant ( $1.38 \times 10^{-23}$  J/K)

T : Cell temperature in Kelvin (K)

V : solar cell output voltage (V)

$R_s$ : Solar cell series resistance ( $\Omega$ )

$R_{sh}$ : Solar cell shunt resistance ( $\Omega$ )

Electrical Characteristics	Ranges
Maximum Power ( $P_{max}$ )	350
Voltage at $P_{max}$ ( $V_{mp}$ )	34.5V
Current at $P_{max}$ ( $I_{mp}$ )	7.25A
Open-circuit voltage ( $V_{oc}$ )	44.1V
Short-circuit current ( $I_{sc}$ )	8.65A
Temperature coefficient of $I_{sc}$	$0.065 \pm 0.015 \% / ^\circ\text{C}$
Temperature coefficient of $V_{oc}$	$-160 \pm 20 \text{ mV} / ^\circ\text{C}$
Temperature coefficient of power	$-0.5 \pm 0.05 \% / ^\circ\text{C}$
NOCT	$47 \pm 2^\circ\text{C}$

### 3. DC-DC Converter Analysis

#### 3.1 Buck Converter

A buck converter or voltage regulator is also called a step down regulator since the output voltage is lower than the input voltage. In a simple example of a buck converter, a diode is connected in parallel with the input voltage source, a capacitor, and the load, which represents output voltage. A switch is connected between the input voltage source and the diode and an inductor is connected between the diode and the capacitor, shown in Figure 3

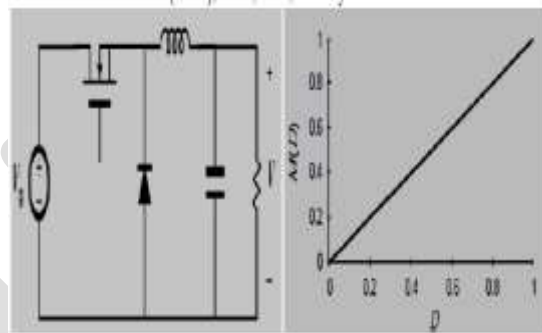
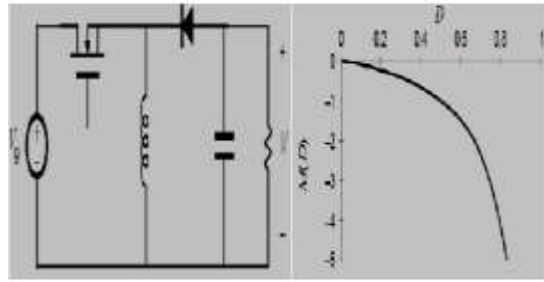

Figure 3. Basic buck converter and its dc conversion ratios  $M(D)$

#### 3.2 Buck-Boost Converter

The last and most important type of switching regulator is the buck-boost converter. In this converter, the buck and boost topologies covered earlier are combined into one. A buck-boost converter is also built using the same components used in the converters covered before. The inductor in this case is placed in parallel with the input voltage and the load capacitor. The switch or transistor is placed between the input and the inductor, while the diode is placed between the inductor and the load capacitor in a reverse direction, shown in Figure 4. The buck-Boost converter provides an output voltage that may be less than or greater than the input voltage



**BOOST CONVERTER:**

**3.3. Working Theory:**

A boost converter or a voltage stepped up converter is a DC-DC converter with yield voltage enhanced contrasted with enter. It is sort of exchanged mode power supplied or SMPS that holds at any rate a diode and a transistor and in any event a vitality putting away component like capacitor, inductor, or the two together. Channels developed utilizing capacitors which in some cases are utilized within synthesis with inductors have been added to converter yield to lessen yield voltage swell

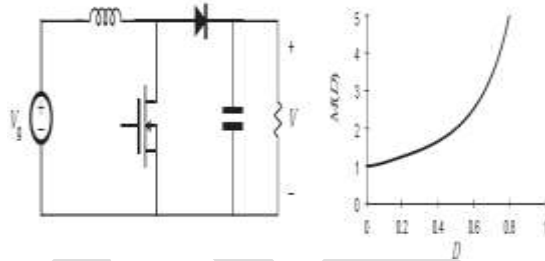

**4. Problem Overview**

The MPPT method consider is to automatically find the current  $I_{MPP}$  or voltage  $V_{MPP}$  at which a PV array should work to extract the maximum output power  $P_{MPP}$  under a given temperature and irradiance. Most of MPPT methods respond to variations in both irradiance and temperature, but some are precisely more useful if temperature is approximately constant. Most MPPT methods would automatically respond to various in the array due to aging, though some are open-loop and would require periodic fine tuning. In our context, module will typically be connected to a power converter that can vary the current coming from the PV array to the load

**5. MPPT Control Algorithm**

The MPPT algorithm operates based on the truth that the derivative of the output power (P) with respect to the panel voltage (V) is equal to zero at the maximum power point. In the literature ,various MPP algorithms are available in order to improve the performance of photovoltaic system by effectively tracking the MPP. However, most widely used MPPT algorithms are considered here, they are:

- Perturb and Observe (P&O)
- Incremental Conductance (In Cond)
- Constant Voltage Method.

**5.1 Perturb and Observe (P&O)**

The most commonly used MPPT algorithm is P&O method. This algorithm uses simple feedback arrangement and little measured parameters. In this approach, the module voltage is periodically given a perturbation and the corresponding output power is compared with that at the previous perturbing cycle [17]. In this algorithm a slight perturbation is introduce to the system. This perturbation causes the power of the solar module varies. If the power increases due to the perturbation then the perturbation is continued in the same direction. After the peak power is reached the power at the MPP is zero and next instant decreases and hence after that the perturbation reverses as shown in Figures 5(a) and 5(b).When the stable condition is arrived the algorithm oscillates around the peak power point. In order to maintain the power variation small the perturbation size is remain very small. The technique is advanced in such a style that it sets a reference voltage of the module corresponding to the peak voltage of the module. A PI controller then acts to transfer the operating point of the module to that particular voltage level. It is observed some power loss due to this perturbation also

the fails to track the maximum power under fast changing atmospheric conditions. But remain this technique is very popular and simple [7].

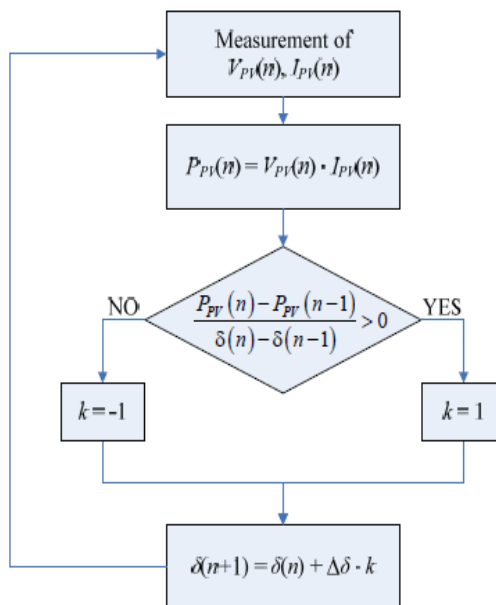
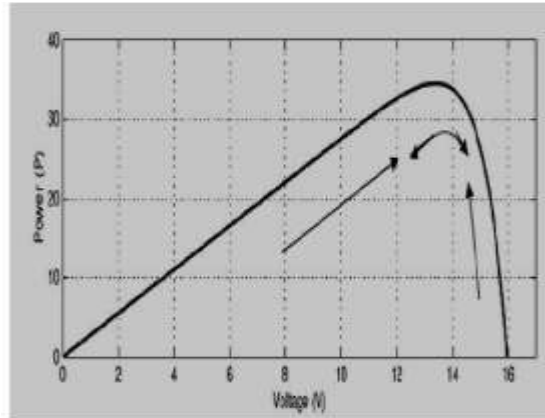

**MATLAB-SIMULINK Environment**

The model shown in Figure represents a block diagram of a PV array connected to a resistive load through a dc/dc (buck or buck boost) converter with MPPT controller

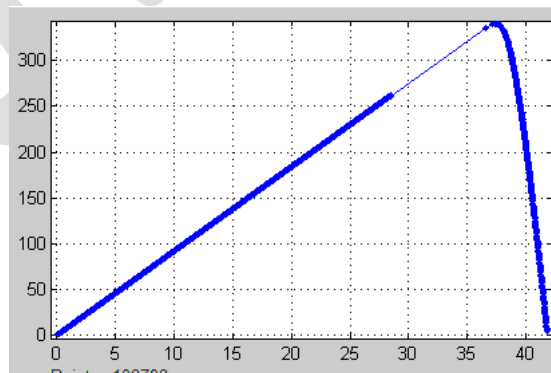

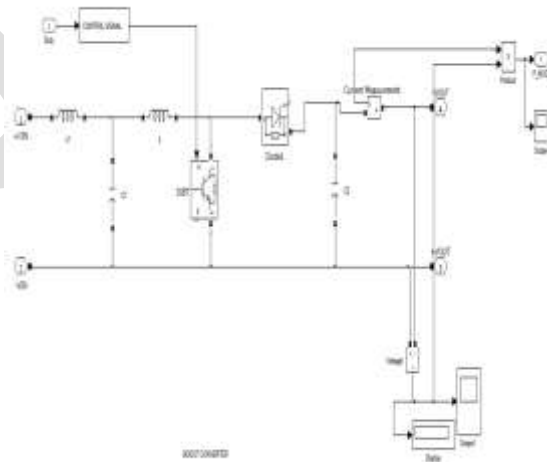
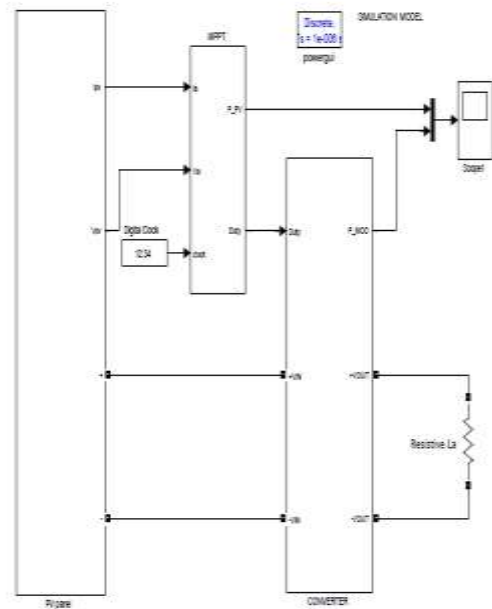
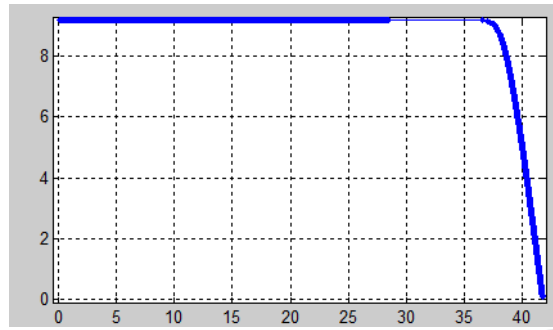

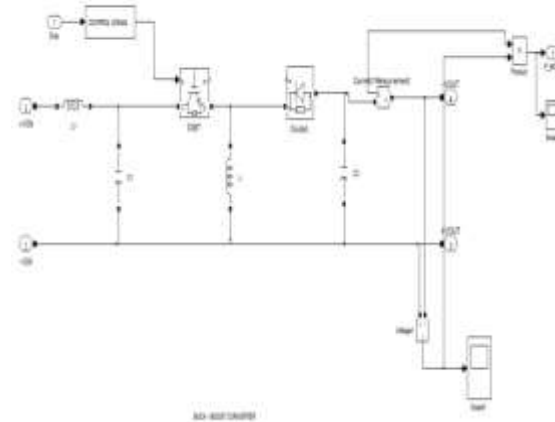
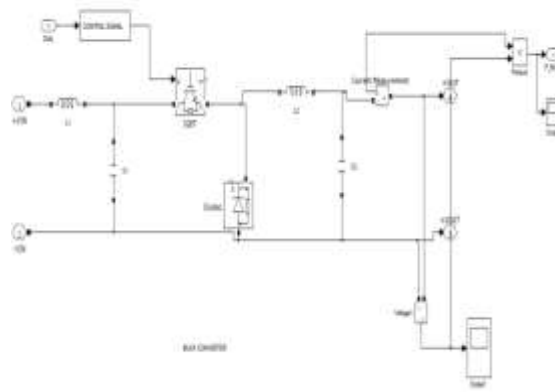

### Results and Simulation

The models shown in the above figures were simulated using MATLAB® / SIMULINK® Simulation and results for buck, boost and buck-boost converters have been recorded to make sure that comparison of the circuit can be obtained accurately. The voltage, current and output power is the main points of comparison to take into account. The complexity and simplicity of the circuit have been set based on the literature. Hardware required, convergence speed and range of effectiveness.

#### Buck-Boost Converter Simulation With Perturb and Observe Controller

The simulation result at constant temperature ( $T=50$  degree) with changes in the insolation ( $S=1000$  to  $850$  w/m<sup>2</sup>)

It can be seen from Figure that the outputs of the PV panels and buck –boost converter clearly changes due to the change of the insolation as that variation of the converter affects the output of the PV panel the results below including current, voltage and power:

AT  $1000\text{w}/\text{m}^2$

At  $T=50$  degree and  $S=1000\text{w}/\text{m}^2$

$I= 9.20$  Ampere,  $V=27.298$  volt and  $P=250$  watt

output of the buck- boost converter with P&O algorithm that results below including current, voltage and power

At  $T=50$  degree and  $S=1000\text{w}/\text{m}^2$

$I=-4.087$  Ampere,  $V=-40.87$  volt and  $P=280\text{w}$

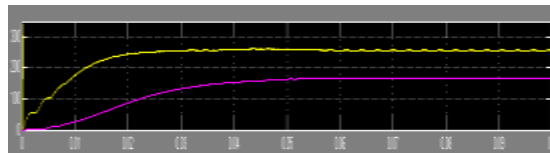

AT  $850\text{w}/\text{m}^2$

From the Figure , the results below current, voltage, power of pv panel

At  $T=50$  degree and  $S=850\text{w}/\text{m}^2$

$I=7.82$  Ampere,  $V=24.15$  volt and  $P= 180$  watt,

the results below current, voltage, power of the buck- boost converter with P&O algorithm

At T=50 degree and S=850 w/ m<sup>2</sup>

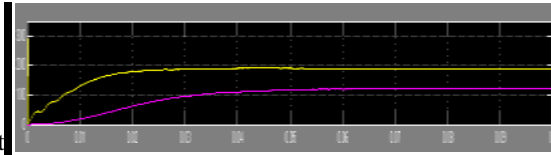

I=-3.471Ampere, V=-34.71volt and P=120watt

### 7.1 Buck Converter Simulation With Perturb and Observe Controller

The simulation result at constant temperature (T=50 degree) with changes in the insolation (S=1000 to 850 w/m<sup>2</sup>).

AT 1000w/ m<sup>2</sup>

Output current, voltage and power of PV panel

At T=50 degree and S=1000 w/ m<sup>2</sup>

I= 1.88 Ampere, V=41.1 volt and P=49 watt

Output current, voltage and power of buck converter with P&O algorithm

At T=50 degree and S=1000 w/ m<sup>2</sup>

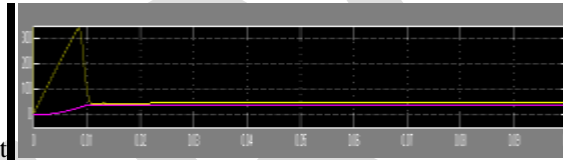

I=1.93Ampere, V=19.73volt P=47watt

AT 850 w/ m<sup>2</sup>

The results below including current, voltage and power pv panel

At T=50 degree and S=850 w/ m<sup>2</sup>

I=1.076 Ampere, V=41.37 volt and P= 48 watt

Output current, voltage and power of buck converter with P&O algorithm

At T=50 degree and S=850 w/ m<sup>2</sup>

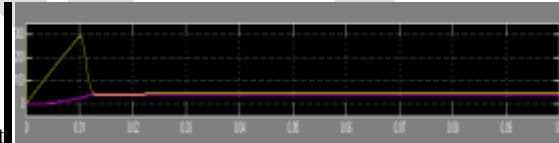

I=1.93Ampere, V=19.5volt P=46watt

### Boost Converter Simulation With Perturb and Observe Controller

The simulation result at constant temperature (T=50 degree) with changes in the isolation (S=1000 to 850 w/m<sup>2</sup>). AT 1000w/ m<sup>2</sup>

output current, voltage and power of PV panel

At T=50 degree and S=1000 w/ m<sup>2</sup>

I= 8.4 Ampere, V=38.1 volt and P=320 watt

Output current, voltage and power of boost converter with P&O algorithm

At T=50 degree and S=1000 w/ m<sup>2</sup>

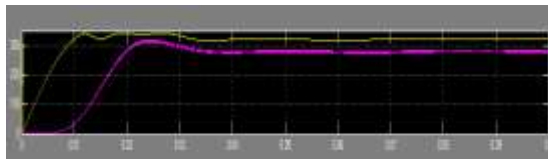

I=3.767Ampere, V=75.33volt and P=280watt

AT 850 w/ m<sup>2</sup>

The results below including current, voltage and power pv panel

At T=50 degree and S=850 w/ m<sup>2</sup>



I=7.85 Ampere, V=36.25 volt and P= 280 watt

The Output current, voltage and power of boost converter with P&O algorithm

At T=50 degree and S=850 w/ m<sup>2</sup>

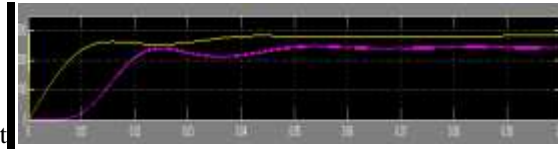

I=3.508Ampere, V=70.17volt and P=250watt

At T=50 degree and S=1000w/ m<sup>2</sup>

CONVERTER	$I_{in}$	$V_{in}$	$P_{in}$	$I_{out}$	$V_{out}$	$P_{out}$
BUCK	1.088A	41.4V	49W	1.943A	39.43V	47W
BOOST	8.404A	38.38V	320W	3.767A	5.33V	280W
BUCK-BOOST	9.20A	27.92V	250W	-4.087A	-40.87V	170W

At T=50 degree and S=850 w/ m<sup>2</sup>

CONVERTER	$I_{in}$	$V_{in}$	$P_{in}$	$I_{out}$	$V_{out}$	$P_{out}$
BUCK	1.076A	41.37V	48W	1.937A	38.5V	47W
BOOST	7.821A	36.25V	280W	3.508A	70.17V	250W
BUCK-BOOST	7.82A	24.15V	180W	-3.471	-34.71V	120W

Table1

From Tables 1&2, once the converters transfer the electrical power from the solar panel to the load and the controller start function, output value of the solar panel do not provide same input voltage value to controller ( $V_{in}$ ). This is because the controller function that varies the value of duty cycle will change the input value that sense by the controller. The input voltages of this controller show a different each other. Input voltage of Buck that connected with P&O is 41.4 V(41.37V at 850 w/ m<sup>2</sup>) while input voltage of buck-boost that connected with P&O is 27.92V (24.15V at 850 w/ m<sup>2</sup>). while input voltage of boost that connected with P&O is 38.38V (36.25V at 850 w/ m<sup>2</sup>). The output value behaves as Buck, boost and buck-boost converters behave. The buck voltage will drop from 41.4V to 19.73V (41.37V to 19.5V at 850 w/ m<sup>2</sup>), while the buck-boost voltage drop from 27.92V to -40.87V (24.15V to -34.71V at 850 w/ m<sup>2</sup>). while the boost voltage rise from V to 38.38V to 75.33V (36.25V to -70.17V at 850 w/ m<sup>2</sup>).

This system show that perturb and observe controller will work better with boost controller than buck-boost and buck converter .

**CONCLUSION:** P&O MPPT method is implemented with MATLAB-SIMULINK for simulation. Through simulation it is observed that the system completes the maximum power point tracking successfully despite of fluctuations. When the external environment changes suddenly the system can track the maximum power point quickly. Boost , buck and buck-boost converters have succeeded to track the MPP but, boost converter is much effective because There is a small loss of power from the solar panel side to the boost converter output side compared with other converters

#### REFERENCES:

- [1] A.P.Yadav, S. Thirumaliah and G. Harith. "Comparison of MPPT Algorithms for DC-DC Converters Based PV Systems" International Journal of Advanced Research in Electrical, Electronics and Instrumentation Engineering Vol. 1, Issue 1, July 2012.
- [2] Y.-H.Chang and C.-Y. Chang, "A Maximum Power Point Tracking of PV System by Scaling Fuzzy Control," presented at International Multi Conference of Engineers and Computer Scientists, HongKong, 2010.
- [3] S.Mekhilef, "Performance of grid connected inverter with maximum power point tracker and power factor control," International Journal of Power Electronics, vol.1, pp. 49-62.
- [4] M.E.Ahmad and S.Mekhilef, "Design and Implementation of a Multi Level Three-Phase Inverter with Less Switches and Low Output Voltage Distortion," Journal of Power Electronics, vol. 9, pp. 594-604, 2009.
- [5] H.N.Zainudin and S. Mekhilef, "Comparison Study of Maximum Power Point Tracker Techniques for PV Systems" Proceedings of the 14th International Middle East Power Systems ConferenceMEPCON'10), Cairo University, Egypt, December 19-21, 2010.
- [6] R.Faranda and S. Leva, "Energy Comparison of MPPT techniques for PV Systems," WSEASTransaction on Power Systems, vol. 3, pp. 446-455.

- [7] Vikrant A. Chaudhari, "Automatic Peak Power Tracker for Solar PV Modules Using DspaceSoftware," in Maulana Azad National Institute of Technology. Master Thesis of Technology inEnergy. Bhopal: Deemed University, 2005.
- [8] T.P.Nguyen, "Solar Panel Maximum Power Point Tracker," Ph. D. Thesis in Department of ComputerScience & Electrical Engineering: University of Queensland, 2001.
- Emerging Trends in Electrical, Electronics & Instrumentation Engineering: An international Journal(EEIEJ), Vol. 1, No1, February 201444
- [9] S.Balakrishna, N. A. Thanoe, G. Rajamohan, A. S. Kenneth and C. J. Ling, "The Study and Evaluation of Maximum Power Point Tracking Systems," International Conference on Energy andEnvironment 2006 (ICEE 2006), pp. 17-22, 2006.
- [10] C.S.Lee, "A Residential DC Distribution System with Photovoltaic Array Integration," Degree of Honors Baccalaureate of Science in Electrical and Electronics Engineering, Oregon State University,University Honors College 2008.
- [11] T.Esram and P. L.Chapman, "Comparison of Photovoltaic Array Maximum Power Point TrackingTechniques," IEEE Transactions on Energy Conversion, Vol. 22, No. 2, 2007.
- [12] E.I.O. Rivera, "Maximum Power Point Tracking using the Optimal Duty Ratio for DC-DC Converters and Load Matching in Photovoltaic Applications," Twenty Third Annual IEEE Applied Power Electronics Conference and Exposition, APEC 2008, pp. 987-991, 2008.
- [13] D.Peftsis, G. Adamidis, P. Bakas and A. Balouktsis, "Photovoltaic System MPPT Tracker Implementation using DSP engine and buck–boost DC-DC converter", 13th Power Electronics andMotion Control Conference, 2008