

Quasi Z-Source DC-DC Converter With Switched Capacitor

Anu Raveendran, Elizabeth Paul, Annie P. Ommen

M.Tech Student, Mar Athanasius College of Engineering, Kothamangalam, Kerala

anuraveendran2015@gmail.com

Abstract— The Z-source converter employs a unique Z-source impedance network to couple the converter main circuit to the power source which can buck or boost the input voltage. The Z-source network consists of two identical capacitors and two identical inductors in X- shape. The Z-source concept can be applied to all dc-to-ac, ac-to-dc, ac-to-ac, and dc-to-dc power conversion. In this paper a quasi Z- source dc-dc converter with switched capacitor is introduced. Quasi Z-source dc-dc converter is derived from the conventional Z- source dc-dc converter. The proposed converter provide higher voltage gain with lower voltage stress of the impedance network capacitors. Moreover, its source and load current are continuous. The performance of the converter is verified using the MATLAB/SIMULINK.

Keywords— Z-source impedance network, inverter, Z-source inverter, Quasi Z-source inverter, dc-dc converter, Z-source converter, Quasi Z-source converter.

INTRODUCTION

The Z- source network, consists of two identical capacitors and two identical inductors in X- shape, was firstly proposed by F.Z peng in 2002 [1]. The Z- source converter employ impedance network to couple the converter main circuit to the power source, load, or another converter. The Z-source concept can be applied to all dc-to-ac, ac-to-dc, ac-to-ac, and dc-to-dc power conversion. The Z- source network was firstly applied in dc-ac inverters. The Z-source inverter can produce the ac voltage greater than or less than the dc input voltage.

The Z- source concept can be applied to dc-dc power conversion. Z source dc-dc converter is proposed in [2].The Z-source dc-dc converter can boost and buck the dc input voltage. When duty ratio less than 0.5 the output voltage is boosted and for duty ratio greater than 0.5 the output voltage is bucked. Here we are concentrating on the boosting action of the converter. Compared to the conventional boost converter, the Z-source dc-dc converter has a higher input-to-output dc voltage boost factor for the same duty ratio.

The traditional Z-source converter has some drawbacks, high capacitor voltage stress of impedance network capacitors, discontinuous source current. In order to avoid this problems quasi Z –source converter derived from the traditional Z-source converter. Along with the advantages of Z-source network topology, quasi Z-source converter has some advantages, such as continuous input current and output current and lower voltage stress on impedance network capacitor. The quasi Z-source concept is also firstly applied in inverters. The quasi Z-source inverter is proposed in [3]. This quasi Z –source concept can be applied to dc-dc power conversion. Quasi-Z-source dc-dc converter is proposed in [3]. The voltage gain of quasi Z-source converter is same as that of Z-source converter.

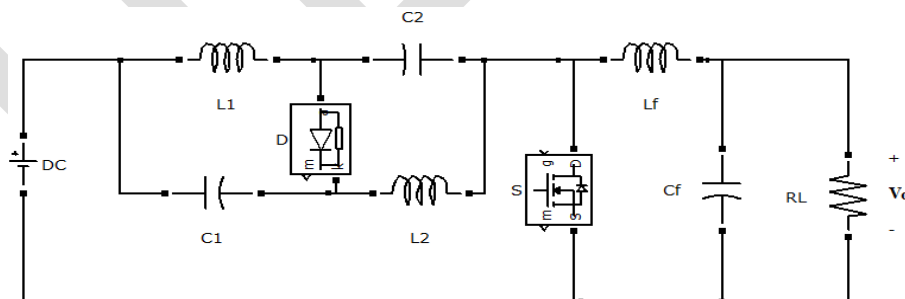

Fig.1: Quasi Z-source dc-dc converter

In this paper a quasi Z-source dc-dc converter with switched capacitor is introduced. The switched capacitor network enhances the boost capability of the quasi Z-source dc-dc converter. The switched capacitor consists of two diodes and two capacitors. This

converter is very suitable to boost low dc voltage from solar and fuel cells. The proposed converter features high voltage gain, lower voltage stress on impedance network capacitors and continuous input and output current.

QUASI Z- SOURCE DC-DC CONVERTER WITH SWITCHED CAPACITOR

The quasi Z-source dc-dc converter with switched capacitor is shown in Fig.2. The circuit consists of input voltage V_i , Z- network, switch S, switched capacitor, a low-pass filter formed by L_f and C_f and the resistive load R_L . The Z-source network composed of the two inductors L_1, L_2 , and the two capacitors C_1, C_2 connected to the primary side of switched capacitor. The two inductors have the same inductance of L , and the two capacitors have the same capacitance of C .

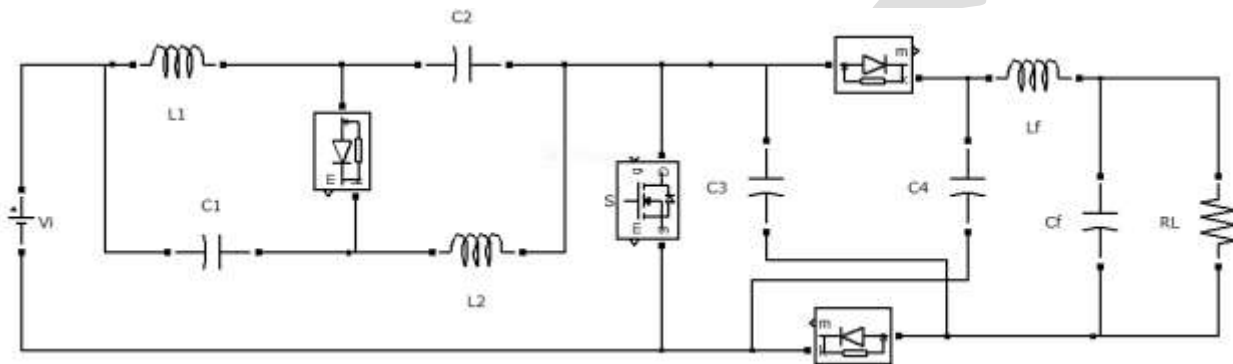

Fig.2: Quasi Z-source dc-dc converter with switched capacitor

The switched capacitor network composed of two diodes D_1, D_2 , and the two capacitors C_3, C_4 is connected to the primary side of the low-pass filter L_f-C_f . The four capacitors C_1, C_2, C_3 and C_4 have the same capacitance C . The quasi Z- source dc-dc converter with switched capacitor has two operating modes. During mode 1 switch S is on and mode 2 switch S is off.

Mode 1 Operation

The equivalent circuit during mode 1 is shown in Fig.3. During this mode inductor L_1 is charged by capacitor C_2 and voltage source V_i , inductor L_2 is charged by capacitor C_1 and voltage source V_i . The energy stored in the inductor L_f is discharged through two capacitors C_3, C_4 and load.

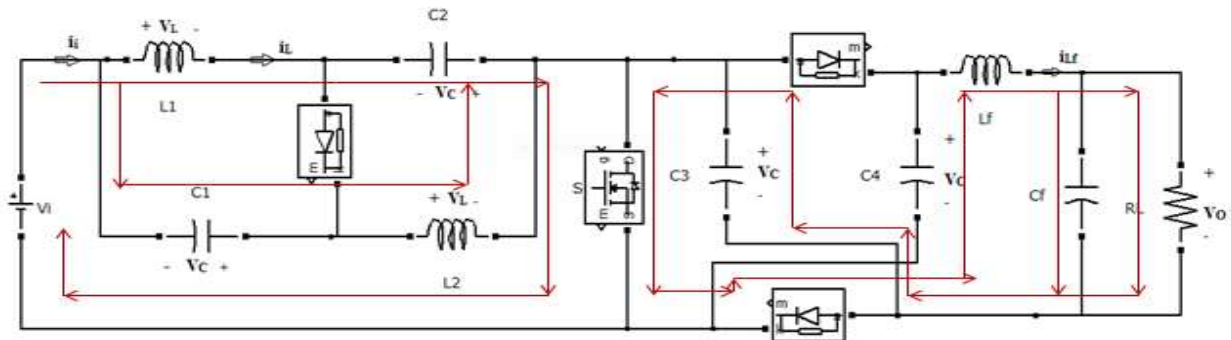

Fig.3: Mode 1 operation

During this time switch voltage V_s is zero, the following equations can be derived,

$$V_L = V_i + V_C \dots\dots\dots(1)$$

$$V_{L_f} = 2V_C - V_O \dots\dots\dots(2)$$

Mode 2 Operation

The equivalent circuit during mode 2 is shown in Fig.4. During this mode the capacitors C_3, C_4 , inductor L_f and load are charged by

by the voltage source V_i and impedance network inductors. Simultaneously capacitors C_1 and C_2 charged from inductor L_1 and L_2 .

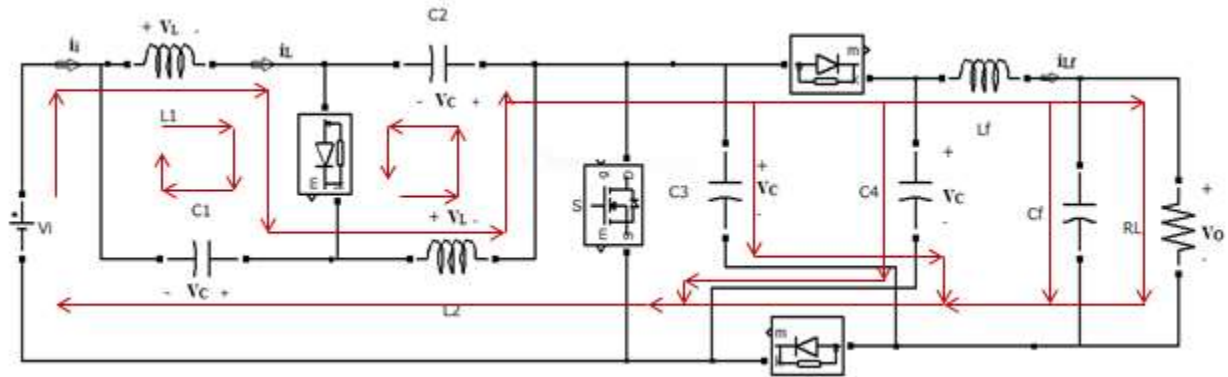

Fig.4: Mode 2 operation

Here,
 $V_L = -V_C$ (3)

$V_{Lf} = V_C - V_O$ (4)

By applying volt –sec balance the voltage gain can be derived as,

Voltage gain, $G = \frac{1+D}{1-2D}$ (5)

The voltage across the impedance network capacitor is ,

$V_C = \frac{D}{1-2D} V_i$ (6)

Based on [5] the proposed quasi Z- source dc-dc converter with switched capacitor provide higher voltage gain compared to the conventional quasi Z- source dc-dc converter. The capacitor voltage V_C in the proposed converter is reduced a voltage V_i and its source and load current are continuous.

DESIGN

Due to the average current of capacitor is zero in the steady state, the average inductor current I_L is equal to the source average current I_i and the average current I_{Lf} of inductor L_f is equal to the output load current I_O . In addition, the input power $P_{in} = V_i i_i$ is equal to the output power $P_{out} = V_o I_o$ under the ideal condition. Therefore, from (5), the following equations are derived,

$$I_L = I_i = \frac{V_o I_o}{V_i} = \left(\frac{1+D}{1-2D} \right)^2 \frac{V_i}{R_L} \dots\dots\dots(7)$$

The inductor voltage V_L is equal to $-V_C$ when switch S is off, combining with (6), the current ripple of the impedance network inductor is,

$$\Delta i_L = \frac{V_C(1-D)T_s}{L} = \frac{(1-D)DV_i}{(1-2D)Lf_s} \dots\dots\dots(8)$$

Based on (7) and (8) the inductance L should satisfy the following equation

$$L \geq \frac{D(1-2D)R_L}{(1-D)\Delta i_L f_s} \dots\dots\dots(9)$$

Where $\Delta i_L = x_L \% I_L \dots\dots\dots(10)$

Therein, $x_L\%$ is usually in the range from 15% to 40%.

The capacitor current is equal to the inductor current when switch S is on. Thus, the voltage ripple of the impedance network capacitor can be expressed as,

$$\Delta V_C = \frac{I_L D T_s}{C} \dots\dots\dots(11)$$

Where $\Delta V_C = x_c \% V_C \dots\dots\dots(12)$

Capacitance can be calculated based on the following equation,

$$C = \frac{(1+D)^2}{(1-2D)x_c \% R_L f_s} \dots\dots\dots(13)$$

SIMULINK MODEL AND RESULTS

The simulink model of the quasi Z- source dc-dc converter with switched capacitor is shown in Fig.5. Simulation is done for an input voltage of $V_i = 24V$, duty ratio $D = 35\%$, switching frequency $f_s = 100kHz$ and $R_L = 50\Omega$. The other parameters used are $L_1=L_2=L_f = 300\mu H$ and capacitors $C_1= C_2=C_3=C_4=C_f = 100\mu F$.

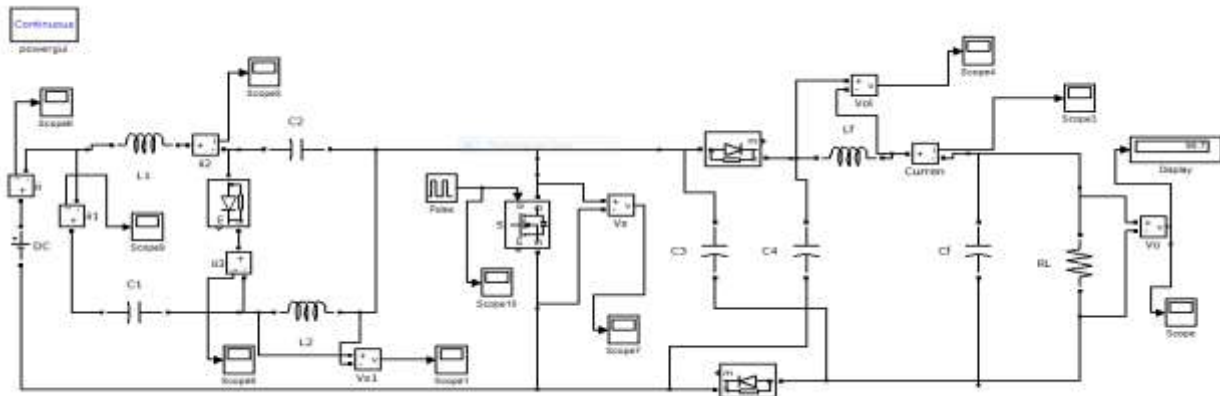

Fig.5: Simulink model of quasi Z-source dc-dc converter with switched capacitor

The pulses given to switch S with duty ratio 0.35 is shown in Fig.6. The load current and source current waveforms are shown Fig.7 and Fig.8.

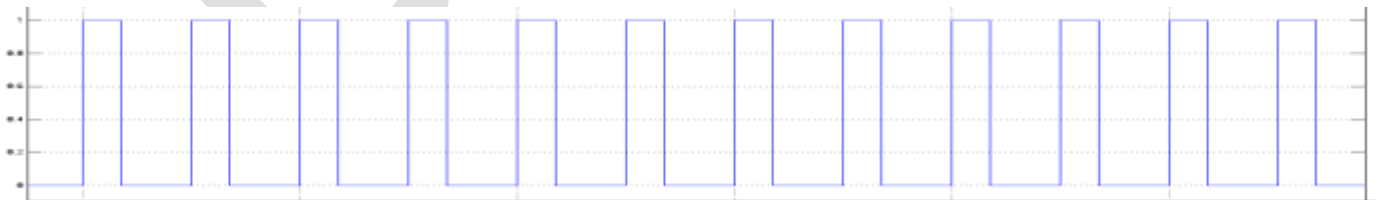

Fig.6: Pulses to switch S with duty ratio 35%

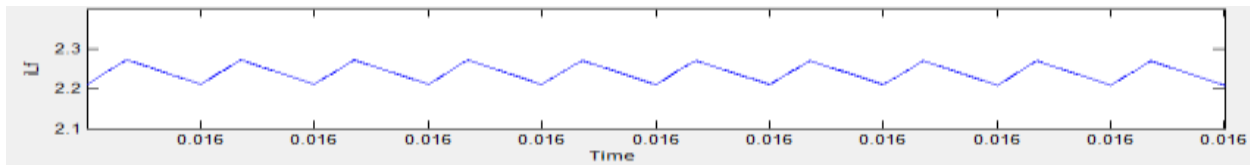

Fig.7: Load current

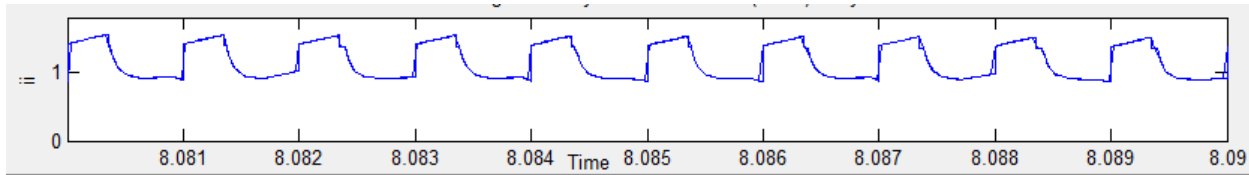

Fig.8: Source current

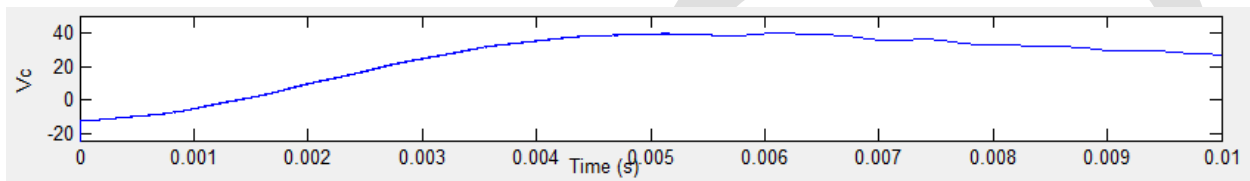

Fig.9: Capacitor voltage

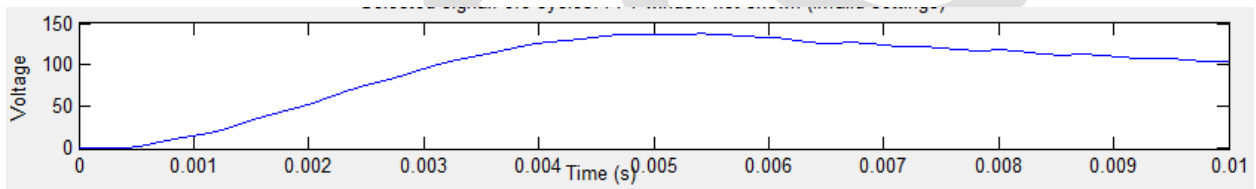

Fig.10: Output voltage

By using this converter we can boost 24V dc input voltage to 108V. By using the quasi Z-source dc-dc converter we can boost 24V dc input voltage to 52V only. Here the source and load current are continuous, which provide advantages for filtering. Here the voltage across the impedance network capacitor is 28V.

CONCLUSION

In this paper a quasi Z- source dc-dc converter with switched capacitor is introduced. This converter is actually derived from the conventional Z-source dc-dc converter. The switched capacitor enhances the boost factor range without any additional active switches. The proposed converter can obtain high voltage gain with lower voltage stress across the impedance network capacitors. Moreover, its source current and load current are continuous. Therefore, it has lower cost and high performance. The proposed converter is suitable for renewable energy systems which need a high voltage gain converter to boost their low input dc-dc clean source voltage.

REFERENCES:

- [14] F. Z. Peng "Z-source inverter" IEEE Trans. Ind. Appl, vol. 39, no. 2, pp. 504-510, Mar./Apr. 2003
- [3] Y. Li, J. Anderson, F. Z. Peng, and D. C. Liu, "Quasi-Z-source inverter for photovoltaic power generation systems," in Proc. 24th IEEE APEC, 2009, pp. 918-924
- [4] V. P. Galigekere and Marian K. Kazimierczuk, "Analysis of PWM Z-source dc-dc converter in CCM for steady state", IEEE Trans.Circuits and Syst. Regul. Pap., vol. 59, no. 4, pp. 854-863, Apr., 2012

- [5] Liqiang Yang, Dongyuan, Bo Zhang, Guidong Zhang, "A Quasi-Z- Source dc-dc converter" IEEE, pp. 941-946, 2014
- [6] Yutaka Shindo, Makoto Yamanaka, and Hiroataka Koizumi, "Z-Source DC-DC Converter With Cascade Switched Capacitor" IEEE, pp.1665-1670, 2011
- [7] J. Anderson and F. Z. Peng, "Four quasi-Z-source inverters," in Proc. IEEE PESC, 2008, pp. 2743-2749
- [8] X. Fang, "A novel Z-source DC-DC converter," in *Proc. IEEE Int. Conf. on Ind. Tech. (ICIT'08)*, pp. 1-4, Apr. 2008.
- [9] Y. Tang, S. J. Xie, C. H. Zhang and Z. G. Xu, "Improved Z-source inverter with reduced Z-source capacitor voltage stress and soft-start capability," IEEE Trans. Power Electron, vol. 24, no. 2, pp. 409-415, Feb. 2009
- [10] M. K. Nguyen, Y. G. Jung and Y. C. Lim, "Single-phase ac-ac converter based on quasi-Z-Source topology," *IEEE Tran. Power Electron.*, vol. 25, no. 8, pp. 2200-2210, Aug. 2010
- [11] Y. Tang, S. J. Xie, C. H. Zhang and Z. G. Xu, "Improved Z-source inverter with reduced Z-source capacitor voltage stress and soft-start capability," *IEEE Trans. Power Electron*, vol. 24, no. 2, pp. 409-415, Feb. 2009
- [12] X. Fang and X. Ji, "Bidirectional power flow Z-source dc-dc converter," in *Proc. Vehicle Power and Propulsion Conf. (VPPC'08)*, pp. 1-5, Sep 2008