

TRACKING MAXIMUM POWER POINT IN AUTONOMOUS PV NETWORK BY ARTIFICIAL INTELLIGENCE USING FUZZY LOGIC TECHNIQUE

GUERNOUDJ. N., FETHA C.

Faculty of Technology, University of Batna2, 05000, Batna, Algeria
nassinguernoudj@gmail.com

Abstract - Traditional regulators, PI, PD and PID in closed loop, are widely used in several applications of power electronics; however recently, there are many researchers who adopted with success in their applications many controllers with artificial intelligence and in particular the fuzzy logic. We are interested in this work to regulate the output voltage of the BOOST converter, precisely our goal is to have a constant output voltage equal to a given reference value quickly and without delay. We are particularly interested in the simulation and control of an autonomous photovoltaic system operating at its maximum power, which supplies a resistive load. The photovoltaic system studied is equipped with a BOOST converter (DC-DC) controlled by a fuzzy MPPT system, which allows it to follow the PPM provided by the photovoltaic panel.

Keywords: Photovoltaic system, artificial intelligence, fuzzy logic, MPPT-Maximum power point tracker, BOOST converter

1. INTRODUCTION

In order to reach the optimum value of the photovoltaic generator, their adaptation system (BOOST converter) must be equipped with an MPPT command, which will act on its duty cycle according to the variations of the meteorological conditions in the environment. In this way, we will present in this work the operation of tracking maximum power by a fuzzy controller for searching the MPP. Then, we will give the results of simulation for the search of the maximum power point for different values of temperatures or irradiancies by using the fuzzy logic technique.

2. PV CELL MODEL

2.1. Characteristic equations

A photovoltaic cell is based on the physical phenomenon called photovoltaic effect which consists of establishing an electromotive force when the surface of this cell is exposed to light. The voltage generated can vary between 0.3V and 0.7V depending on the material

used in the construction of this cell and its layout as well as cell temperature and aging of the cell [1][2].

With regard to the behavior of a real solar cell, two parasitic resistances are taken into consideration for a more accurate description (fig. 1.) [3][1].

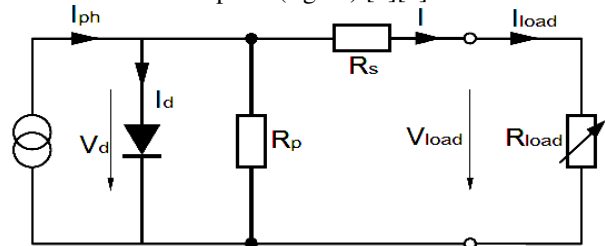

Fig. 1. Equivalent electrical circuit of a real solar cell connected to a load

In practice, parallel resistance R_p is very important (in the order of mega Ohm) and the series resistance R_s is very small (in the order of a few milli-ohms). With such an equivalent electric circuit, we can write [4][5]:

$$I = I_{ph} - I_d - \frac{V_d}{R_p} \quad (1)$$

$$V_d = V + R_s * I \quad (2)$$

$$I = I_{ph} - I_s \left(e^{\frac{V + R_s * I}{n * V_t}} - 1 \right) - \frac{V + R_s * I}{R_p} \quad (3)$$

with: $V_t = K * T / q$

where: I is the cell current, I_d is the diode saturation current, I_{ph} is the photo current, I_s is the reverse saturation current of diode, V_d is the diode voltage, V_t is the temperature voltage, V is the cell voltage, T is the cell operating temperature in Kelvin, R_s is the cell series resistance, R_p is the cell shunt resistance, K is the Boltzmann's constant (1.381×10^{-23} J/K), q is the electron charge (1.602×10^{-19} C).

2.2. Parameters of PV module studied

The KC 200GT module is chosen for simulation. This module consists of 54 solar cells multi-crystalline on silicon connected in series and provides a nominal power of 200.143W [6], the table 1 gives its electrical characteristics.

Table 1. Typical electrical characteristics of KC 200GT Solar PV model [6]

Electrical characteristics	KC 200GT
Max. power system (P_{MP})	200.143W
Max. Current system (I_{MP})	7.61A
Max. voltage system (V_{MP})	26.3V
Short-circuit current (I_{SC})	8.21A
Open-circuit voltage (V_{OC})	32.9V
Series resistance (R_S)	0.221 Ω
Parallel resistance (R_p)	415.405 Ω
Number of series cells (N_S)	54
Ideal factor of the junction (n)	1.3

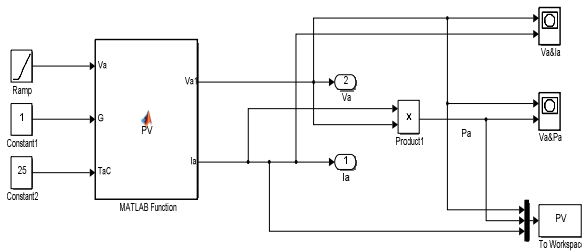

Fig. 2. PV array simulation model using MATLAB

2.3. MATLAB function of PV array

```
function [Va1,Ia] = Iphoton(Va, G, TaC)
TaC=25; %Operating Temperature in celsius
G=1; %Actual Irradiance [kW/m2]
K=1.38065e-23; %Boltzman Constant
q=1.602e-19; %Electron's Charge
Iscn=8.21; %Desigerable Short Circuit Current
Vocn=32.9; %Desigerable Open Circuit Voltage
Kv=-0.1230; %Temperature Voltage Constant
Ki=0.0032; %Temperature Current Constant
Ns=54; %Number of Series Conected Cells
TaK=TaC+273.15; %Operating Temperature in Kelvin
Tn=+273.15; %Temperature at STC
Gn=1; %Irradiance at STC [kW/m2]
n=1.3; %Diode Ideality Constant [1<a<2]
Eg=1.12; %Band Gap of silicon
Rs=0.221; %Series Resistance of Equivalent PV
Rp=415.405; %Parallel Resistance of Equivalent PV
% Va1=Va;
%calcul
Vtn=Ns*((K*Tn)/q);
I0n=Iscn/((exp(Vocn/(n*Vtn)))-1);
I0=I0n*((Tn/TaK)^3)*exp(((q*Eg)/(n*K))*((1/Tn)-(1/TaK)));
Ipvn=Iscn;
Ipv=(G/Gn)*(Ipvn+Ki*(TaK-Tn));
Vt=Ns*((K*TaK)/q);
i=1;
Ia(1)=0;
for (Va=Vocn: -0.1: 0)
I_term1=I0*(exp((Va+Ia(i)*Rs)/(Vt*n))-1);
I_term2= (Va+Ia(i)*Rs)/Rp;
Ia(i+1)=Ipv-(I_term1+I_term2);
if Ia(i)>0
Ia(i)=Ia(i);
else
Ia(i)=0;
end
Pi(i)=Va*Ia(i);
Vi(i)=Va;
i=i+1;
end
%Characteristics
figure(1)
plot(Vi(1:i-1),Ia(1:i-1),'r', 'Linewidth',2.5)
```

```
xlabel('Voltage (V)');
ylabel('Current (A)');
figure(2)
plot(Vi(1:i-1),Pi(1:i-1),'b', 'Linewidth',2.5)
xlabel('Voltage (V)');
ylabel('Power (W)');
```

2.4. PV array characteristics

To see the graphs of characteristics concerning the PV array that we will study in this paper you can use MATLAB model block (fig. 2.). but you have to cancel the instructions of *TaC* and *G* by adding % at the start and activate *Va1* by eliminating %, otherwise you can launch the above program directly.

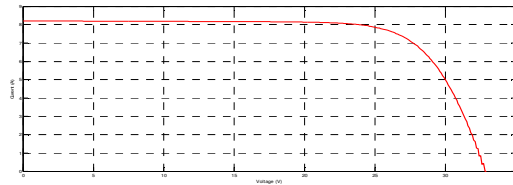

Fig. 3. I – V characteristics adjusted to three remarkable points under ($G=1kW/m^2$) and ($T=25^\circ C$)

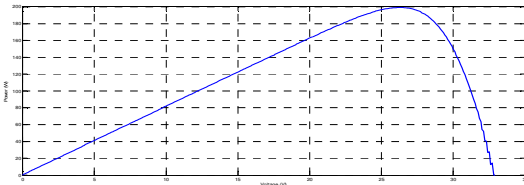

Fig. 4. P – V characteristics adjusted to three remarkable points under ($G=1kW/m^2$) and ($T=25^\circ C$)

3. MODELING OF THE BOOST CONVERTER

The BOOST converter is generally used in the conversion to increase the voltage value at the output. Here we used a converter that consists of a DC input voltage source ($+Vin, -Vin$), inductance *L*, switch *S*, diode and capacitor *C* (fig. 5.). The simulation block of the proposed BOOST converter is shown in (fig. 6.). and the control signal (DC-DC) presented in (fig. 6.). is well represented in (fig. 7.). by details.

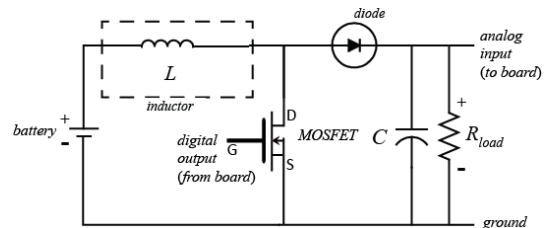

Fig. 5. Basic circuit of the BOOST converter

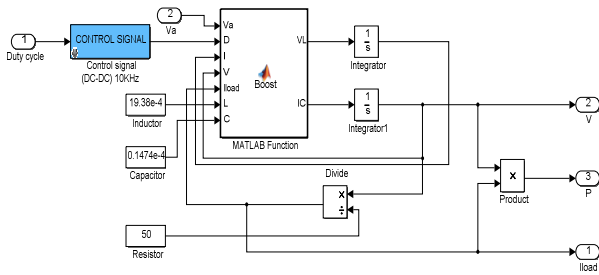

Fig. 6. BOOST converter model under MATLAB

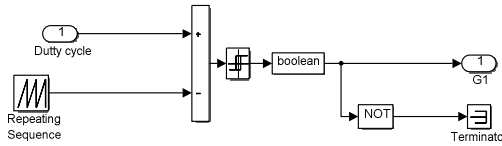

Fig. 7. Control signal (DC-DC) 10kHz under MATLAB

3.1. MATLAB function of BOOST converter

```
function [VL,IC] = Boost(Va,D,I,V,Iload,L,C)
%Boost Converter Specifications:
D1 = (1-D); % D = Duty cycle
VL = (Va - (V*D1))/L; % Va = Input voltage, V = Output voltage
IC = ((I*D1) - Iload)/C; % I = Inductor current, Iload = Load current
```

3.2. Dimensioning of the LC filter for the BOOST converter

The calculation of $V_{(output)}$ at the end of converter, D , L , C and R is given by the following equations [7]:

$$V_{(output)} = V_{(input)} \cdot \frac{1}{(1 - D)} \tag{4}$$

$$D = 1 - \frac{V_{(input)}}{V_{(output)}} \tag{5}$$

$$L = \frac{V_{(input)} \cdot D}{\Delta I \cdot f_s} \tag{6}$$

$$C = \frac{I_{(output)} \cdot D}{\Delta V_{(output)} \cdot f_s} \tag{7}$$

where: D is the duty cycle, $V_{(input)}$ is the boost input voltage, $V_{(output)}$ is the boost output voltage, $I_{(output)}$ is the boost output current, ΔV is the variation of the voltage, L is the boost inductor, C is the boost capacitor, f_s is the switching frequency.

Application:

Assuming that we want to realize a BOOST converter under an input voltage $V_{(input)} = V_{mp} = 26.3V$ to have an output voltage $V_{(output)} = 100V$, and a current $I_{(output)} = 2A$ so if $\Delta I = 0.1A$ and $\Delta V = 1V$, $f_s = 10kHz$ we find:

$$D=0.737, L=19.38mH, C=147.4\mu F.$$

4. TRACKING MPP USING FUZZY LOGIC TECHNIQUE

The principle of a fuzzy control is based on two input variables which are the error (E) and the error change (ΔE) and an output variable (ΔD) (variation of the duty cycle) [8].

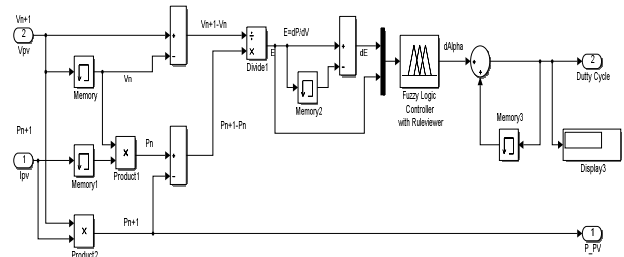

Fig. 8. Fuzzy logic controller model under MATLAB

4.1. Algorithm

In follows, we will detail the design steps of the fuzzy controller in order to tracking the PPM. The fuzzy controller has the following three blocks: Fuzzification of input variables by the use of trapezoidal and triangular functions, the inference where these fuzzified variables are compared with predefined sets to determine the appropriate response, and finally defuzzification to convert fuzzified subsets into values [9].

MATLAB code of our FIS Editor GUI characteristics is written as follows:

```
[System]
Name='FLC'
Type='mamdani'
Version=2.0
NumInputs=2
NumOutputs=1
NumRules=49
AndMethod='min'
OrMethod='max'
ImpMethod='min'
AggMethod='max'
DefuzzMethod='centroid'
```

a) Fuzzification

A fuzzy controller with two inputs and one output was designed. The two input variables are Error (E) and Change of Error (ΔE) [10], which are shown in (equations 8 and 9) for sample time k . These inputs variables are expressed in terms of linguistic variables or labels, 7 variables in our case as used in basic fuzzy sets.

- NB : negative – big
- NM : negative – medium
- NS : negative – small
- ZE : zero
- PS : positive – small
- PM : positive - medium
- PB : positive – big

The variables E and ΔE are expressed as follows:

$$E(k) = \frac{\Delta P}{\Delta V} = \frac{P(k) - P(k-1)}{V(k) - V(k-1)} \quad (8)$$

$$\Delta E(k) = E(k) - E(k-1) \quad (9)$$

where: $E(k)$ is the error, $P(k)$ is the power of the PV generator, $V(k)$ is the voltage of the PV generator, ΔE is the variation of the error, ΔP is the variation of the power, ΔV is the variation of the voltage.

Therefore: $E(k) = 0$ at the maximum power point of the PV generator.

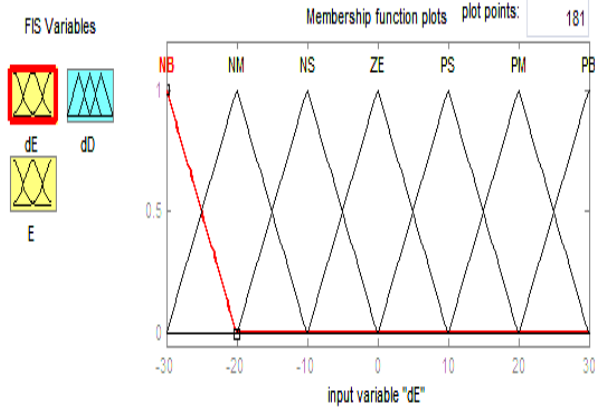

Fig. 9. The fuzzy membership function for input (ΔE)

MATLAB code of our fuzzy membership function for input (ΔE) is written as follows:

```
[Input1]
Name='dE'
Range=[-30 30]
NumMFs=7
MF1='NB':trimf,[-39.99 -30 -20]
MF2='NM':trimf,[-30 -20 -10]
MF3='NS':trimf,[-20 -10 0]
MF4='ZE':trimf,[-10 0 10]
MF5='PS':trimf,[0 10 20]
MF6='PM':trimf,[10 20 30]
MF7='PB':trimf,[20 30 40.02]
```

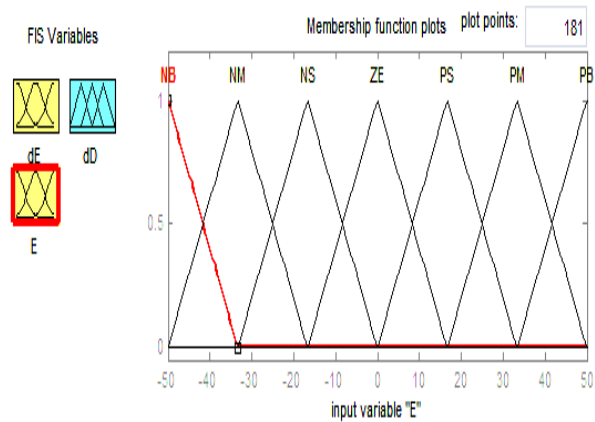

Fig. 10. The fuzzy membership function for input (E)

MATLAB codes of our fuzzy membership function for input (E) is written as follows:

```
[Input2]
Name='E'
```

```
Range=[-50 50]
NumMFs=7
MF1='NB':trimf,[-66.67 -50 -33.33]
MF2='NM':trimf,[-50 -33.33 -16.67]
MF3='NS':trimf,[-33.33 -16.67 0]
MF4='ZE':trimf,[-16.67 0 16.67]
MF5='PS':trimf,[0 16.67 33.33]
MF6='PM':trimf,[16.67 33.33 50]
MF7='PB':trimf,[33.33 50 66.7]
```

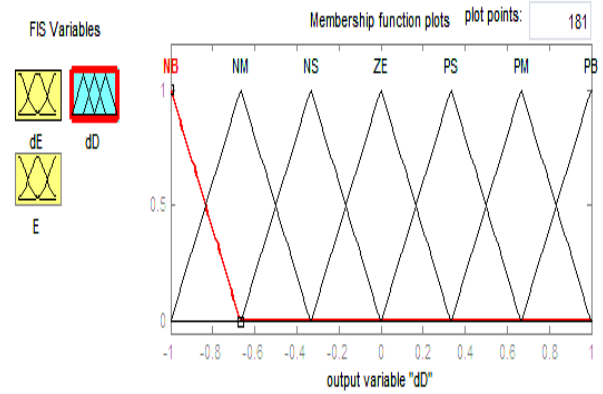

Fig. 11. The fuzzy membership function for output (ΔD)

MATLAB code of our fuzzy membership function for output (ΔD) is written as follows:

```
[Output1]
Name='dD'
Range=[-1 1]
NumMFs=7
MF1='NB':trimf,[-1.3333 -1 -0.6667]
MF2='NM':trimf,[-1 -0.6667 -0.3333]
MF3='NS':trimf,[-0.6667 -0.3333 0]
MF4='ZE':trimf,[-0.3333 0 0.3333]
MF5='PS':trimf,[0 0.3333 0.6667]
MF6='PM':trimf,[0.3333 0.6667 1]
MF7='PB':trimf,[0.6667 1 1.3333]
```

b) Inference system

The table 2 shows the rules of the fuzzy controller, where all the inputs of the matrix are the fuzzy sets of the error (E), the variation of the error (ΔE) and the variation of the duty cycle (ΔD) for the BOOST converter. In the case of fuzzy control, the control rule must be designed so that the input variable (E) must always be zero.

Table 2. Fuzzy logic controller inference rules base

$E \backslash \Delta E$	NB	NM	NS	ZE	PS	PM	PB
NB	NB	NB	NB	NB	NM	NS	ZE
NM	NB	NB	NB	NM	NS	ZE	PS
NS	NB	NB	NM	NS	ZE	PS	PM
ZE	NB	NM	NS	ZE	PS	PM	PB
PS	NM	NS	ZE	PS	PM	PB	PB
PM	NS	ZE	PS	PM	PB	PB	PB
PB	ZE	PS	PM	PB	PB	PB	PB

c) Defuzzification

We have seen that the inference methods provide a function for the resulting membership variable; it is therefore fuzzy information. Since the converter (DC-DC) requires a precise control signal at its input, it is

necessary to provide a transformation of this fuzzy information in given information, this transformation is called defuzzification [10].

4.2. Fuzzy MPPT command simulation results

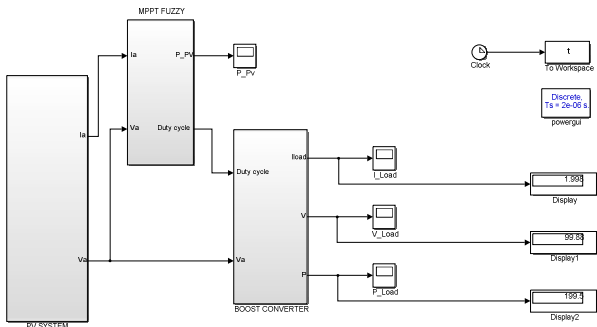

Fig. 12. All PV system modeling under MATLAB

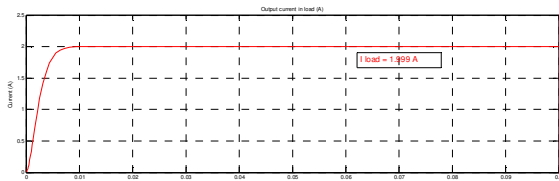

Fig. 13. Output current in load under ($G=1\text{kW/m}^2$ & $T=25^\circ\text{C}$)

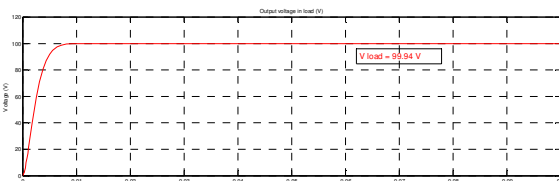

Fig. 14. Output voltage in load under ($G=1\text{kW/m}^2$ & $T=25^\circ\text{C}$)

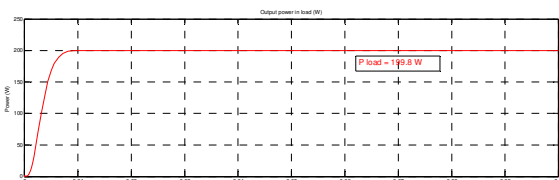

Fig. 15. Output power in load under ($G=1\text{kW/m}^2$ & $T=25^\circ\text{C}$)

The Fuzzy MPPT technique was simulated at the beginning using a (DC-DC) BOOST converter, in a fixed irradiation ($G=1\text{kW/m}^2$) and a fixed temperature ($T=25^\circ\text{C}$), this converter is connected to a resistive load ($R=50\Omega$).

Note that the output current to the load (fig. 13.) has a value almost equal to the desired current value ($I=2\text{A}$), here ($I_{Output}=1.999\text{A}$) this value is proportional to the current value generated by the solar panel after passing through the BOOST converter used.

Note that the output voltage to the load ($V_{Output}=99.94\text{V}$) (Fig. 14.) has a significant value

compared to the input voltage of the PV generator ($V_{Input}=26.3\text{V}$); it is the effect of the Boost converter.

The output power to the load (Fig. 15.) has a value very close to the maximum power value of PV ($P_{Output}=199.8\text{W}\approx P_{MP}$). So we managed to run the PV generator under maximum power MPP almost without any loss and any disturbance.

According to these results the regulation by the fuzzy logic is robust, reliable and very fast also; indeed, the output voltage reaches the desired value in 0.01s.

5. CONCLUSION

Fuzzy logic control can be seen as a step towards bringing precise mathematical control closer to human decision-making. FLC has proven that it has better performance, fast response time and very low permanent state error, a minimum ripple rate of voltage and power, very high efficiency of PV; indeed, it runs at its maximum power, and most importantly: the fuzzy MPPT has managed to put the voltage value at the BOOST converter output constant and equal to a reference value almost without loss.

REFERENCES

- [1]. Emanuel, F.M. - "Decentralized production in distribution networks. Multidisciplinary study of modeling for source control". Doctoral Thesis National School of Arts and Crafts, 2007.
- [2]. Christophe, M. et al. - "Research project integrates 6.2, Integration of hybrid photovoltaic-thermal sensors on the frame". Final report, France, 2004.
- [3]. Antonio, L. and Steven, H. - "Handbook of Photovoltaic Science and Engineering", John Wiley & Sons Ltd, 2003.
- [4]. Trishan, E. and Patrick, L.C. - "Comparaison of Photovoltaic Array Maximum Power Point Tracking Techniques". IEEE transactions on energy conversion, vol. 22, no. 2, June 2007.
- [5]. Lionel, V. - "Modeling and Analysis of the Integration of Renewable Energies in an Autonomous Network", University of Havre, 2005.
- [6]. Datasheet KC 200GT photovoltaic module.
- [7]. HAUKE, B. - "Basic Calculation of a Boost Converter's Power Stage". Texas instruments .Application Report SLVA372C–November 2009.
- [8]. Kermadi, M. and Berkouk, E.M. - "Artificial intelligence-based maximum power point tracking controllers for photovoltaic systems: comparative study". Renewable and Sustainable Energy Reviews, vol. 69, pp. 369-386, 2017.
- [9]. Fadali, M.S. Jafarzadeh, S. and Nadeh, A. - "Fuzzy TSK approximation using Type-2 fuzzy logic systems and its application to modeling a photovoltaic array". Proc. American Control Conference, pp. 6454-6459, July 2010.
- [10]. Gounden, N.A, Peter, S.A, Nallandula, H, and Krithiga, S. - "Fuzzy logic controller with MPPT using line-commutated inverter for three-phase grid-connected photovoltaic systems". Renewable Energy Journal. 34, 909-915, (2008, 11, July).