

# AUTOMATIC BUILDING INTEGRATED SOLAR SHADE

AHMED S. MOHAMED, OSAMA M. ABUZOID, ABDULRAZAK A. AMMAR,  
ABDULRAHMAN A. A. EMHEMED

Electrical Engineering Department, College of Technical Sciences, Bani Walid, Libya  
ahmeden198119@yahoo.com, osamamasuod233@gmail.com, abdul2200@yahoo.com,  
abdo\_83f@yahoo.com

**Abstract-** This paper presents an Automatic Building Integrated Solar Shade system (ABISS). It was discovered that solar radiation is prevented from getting into the buildings; with the solar blind tracking system would overcome the difficulties. ABISS is designed and developed in order to generate constant, reliable and efficient power supply. ABISS is designed using Proteus software to simulate behavior of the system (software and hardware design) before implementation. Furthermore, the ABISS is designed to track the position of the sun automatically in order to improve an efficient energy harvest. Light Dependent Resistors (LDRs) are used to detect the light intensity of the sun. Based on its signal, the Microcontroller (PIC18F4520) gives a signal to the motor driver to energize the unipolar stepper motor. This results in moving the integrated solar panel into rotational angles to track the position of the sun. This will lead to improve solar tracking system efficiency of the Photovoltaic (PV) while maintaining the orientation of the integrated PV at an optimal tilt angle. In addition, sleep mode is used to reduce energy consumption of the Microcontroller. The Microcontroller resumes operation caused by an external interrupt from a Real Time Clock (RTC) after 15 minutes of sleep. The embedded code is developed by using C language; in order to achieve the all functions of the ABISS design. The paper also investigates the effect of the solar shading system, using the appropriate technique of a solar tracking system.

**Keywords;** Integrated Solar Shade, Light dependent resistors (LDRs), unipolar stepper motor, Automatic Building.

## 1. INTRODUCTION

The rapid increase in the world's population combined with the scarcity of natural resources has led to a significant increase in the demand for a clean and renewable energy source[1]. Solar energy is one of the emerging technologies which are expected to deal with the energy scarcity in the coming decades[2]. Reducing environmental pollution and energy consumptions are one of the current international research topics, and solar energy is pollution free. The development and utilization of renewable, clean energy, and actively looking for new

energy saving technology is the best way to deal with an energy crisis and ecological crisis[3]. The main target of the proposed system in this paper is to reduce the side effects of shading, by the reconfiguration of an electrical connection of panels; hence, the development of an automatic reconfiguration system for PV panels. This will be operating under shady conditions in order to increase the power output of the PV panel. The automatic reconfiguration system is built using an embedded programming code and MPLAB. The results of the designed paper were evaluated with computer simulations using Proteus software. It was observed that the solar panel can be used in various applications, in non-uniform condition, because of the shading caused by trees, clouds, neighboring houses and shadows of the modules of the panel, and the shading photo voltaic can cause some unwanted effects[4]. Santos et al. (2011) argued that the total power produced by PV is less than expected, therefore there is a higher tendency of load loss. Photovoltaic cells can be rendered nonfunctional due to the development of hot spots in the shaded panel, so a number of methods have been explored as viable options to decrease the unwanted effects of shading on PV panels. The two most commonly used methods are the use of blocking diodes and introducing an extra connection in the form of bypass diodes. The mechanism by which blocking diodes works is to render the parallel branches of the circuit insensitive to a branch with a low voltage, whereas the bypass diode helps to maintain the proper temperature of the damaged shade cells [5]. Partially shaded conditions are a serious problem in solar modules, making them work under lower efficiency when compared with steady state conditions[6]. In large systems, Individual solar modules can be mounted to an individual converter, thus making it possible to operate close to the maximum power point (MPP), which improves the efficiency of the complete system[7]. Photovoltaic (PV) and wind turbine are renewable and clean since they do not produce unwanted green-house gases. The aim of this paper is to study the characteristic of output power from PV system and wind turbine. The experimental study was conducted at the Laboratory of Thermodynamics and Heat Transfer. PV system was modeled by using basic circuit current equations with varying irradiation of 400, 600, 800, and 1000 W/m<sup>2</sup>, constant cell temperature of 25 °C, maximum power point tracking (MPPT), and DC-DC boost converter of 12/25 V. The characteristic of PV panel indicated that the maximum current is 1.84 A and

maximum voltage is 28 V where the power is 41 W. The efficiency of PV reached highest at radiation intensity of 1000 W/m<sup>2</sup> is 8.8%. The wind turbine produced voltage of 31 V and current 1.3 A at wind speed of 6 m/s. The power coefficient of wind turbine at wind speed of 6 m/s is 0.23. The experimental results showed good agreement for PV system and wind turbine [8].

Mahjoubi(2019) had studied the solar radiation data available at two meteorological stations located in the south of Tunisia. Measurements of global solar radiation on horizontal surface are compared to predictions made by different methods. The methods for estimating global solar radiation based upon three empirical models (Angström-Prescott, Mechlouch, and Sivkov model). The performance of the models was checked with coefficient of determination R<sup>2</sup> and three statistical indices: the Mean Percentage Error (MPE), the Root Mean Square Error (RMSE) and Mean Bias Error (MBE). The results show that these models will be useful for the design of various systems using solar energy in the south of Tunisia especially in cases where radiation measurements are not readily available [9].

This paper aims to develop an emergency alternative, which involves the electrical connections of the PV panels. This will ensure that the panel will work as a less variable power source, regardless of shaded conditions. Hence, this paper presents a new technique to the alternative energy, i.e. the improvement of a system for automatic integrated of shaded PV panels, by the use of a solar blind. Building photovoltaic systems that often operate under particularly shaded conditions, current versus voltage characteristics and power versus voltage characteristics of PV arrays are characterised by multiple steps and peaks under particular shade conditions. Most of the exiting strategies always fail to track the real maximum power, but energy efficiency and low-carbon emissions are taken seriously by people. A maximum power point tracking method with the ability to detect the partial shaded occurrence on PV array, and employs a current control methods for tracking the global maximum between the local maximums[6]. A study of the influences of shading on electrical parameters of PV panels by analysing their approximate equations is presented by[5]. The PV panel has shown a better alternative source of power for areas which have scarcity in the power supply of electric energy because of the factors like: ease of expansion, simplicity in the installation, low maintenance and high reliability. Solar energy as an alternative and unlimited supply of clean energy is becoming an important new energy source[3].

The paper is organized as follows: Section I introduce a brief introduction to Automatic Building Integrated Solar Shade, Section II describes the methodology involved involved two sections: software and hardware design, Section III shows the technical results, and finally, Section VI Highlights the conclusions.

## 2. METHODOLOGY

The paper involved two sections: software and hardware design. It is believed that solar radiation is prevented

from passing into the building at most times, depending on the seasonal condition. The paper is an operable system designed to overcome the difficulties, which will track the position of the sun in order to increase the system's shading efficiency. The project design was simulated on Proteus software; the simulation process will help the reader to understand the design and theory of the Automatic Building Integrated Solar Shade system. This will lead to improve the solar tracking system of the PV effectiveness and maintain the system's stability. In the design, light dependent resistance (LDR) is used to detect the light intensity of the sun and according to its signal to the PIC (PIC18F4520), which will give a signal to the stepper motor driver that will actuate the unipolar stepper motors to move the solar panel into rotational angles. This will enable the system to rotate the PV panel in order track the position of the sun, where by the two LDR sensors are the same in terms of illumination in capacity, and their resistance is almost the same. If either of the sensors happen to be in shade, their resistance increase above the range, or the PIC microcontroller should be able to energize the same motor to drive the two sensors under illumination. If LDR<sub>1</sub> falls into shade, the tracker rotates forward, whereas when LDR<sub>2</sub> falls in shadow, the tracker rotate to backward (see Fig.1).

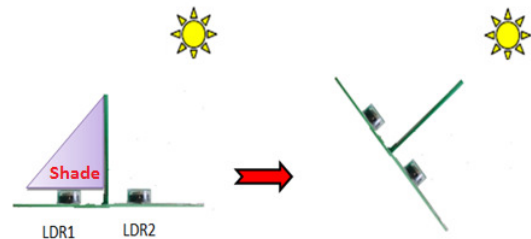

Fig.1. Principle operation of LDR module sensor.

### 2.1. Software Design

In the software design as illustrated in Fig.2 various devices were used to carry out the tasks including: Portus software, microcontroller (PIC18F4520), and LDRs which are used to test the system's behavior before the hardware implementation. The separate codes of C language that performed different functions were compiled and implemented using the MPLAB compiler; the programming code has various functions which include:

- Interfacing LDRs with PIC18F4520 through its inbuilt 10bit ADC (port A).
- Driving and controlling the stepper motor using ULN2803 based on the LDR's input to the microcontroller.
- Interfacing two Hall Effect Sensors US5881 with PIC18F4520 in order to stop the stepper motor movement at a maximum position in case of closing and opening the system.

- Interfacing Real Time Clock (RTC) with PIC18F4520 using DS1337, to be used as an external interrupt to wake up the PIC18F4520.

In order to create the main program code the previous stages of separate codes will be combined or merged after completion.

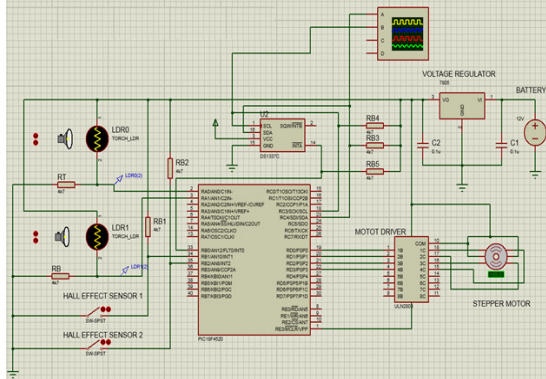

Fig.2. The software circuit design of ABISS.

## 2.2. Hardware Design

The hardware designed is sub-divided into two different parts; the hardware design of the tracking system and build solar shade system. Each part has own separate functions as well as the code. Every part worked independently but finally joined together to achieve one target. The block diagram of the system is shown in Fig.3.

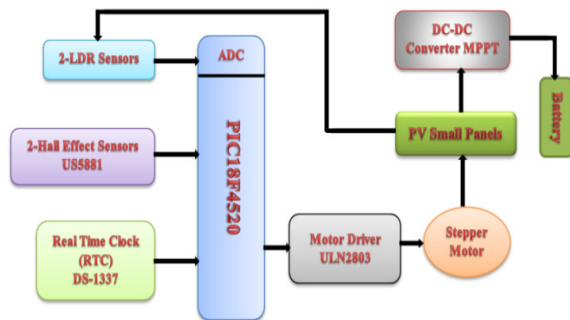

Fig. 3. Project block diagram.

### a) Circuit Design

Design Section of this project, the LDR module sensors and stepper motors are interfaced to the PIC18F4520, wherein the microcontroller responds by generating pulses that will drive the stepper motors through the Darlington IC ULN2803. Fig.4 shows how the PCB is connected to a breadboard in order to verify and check its functionality. In order to make the series of connections work, each of the LDRs should be properly connected and tested to obtain the expected results before moving on to the next process. Upon passing the first process, the stepper motors are then connected and tested

through the ULN2803, wherein a digital pulse meter and oscilloscope were used to measure the results.

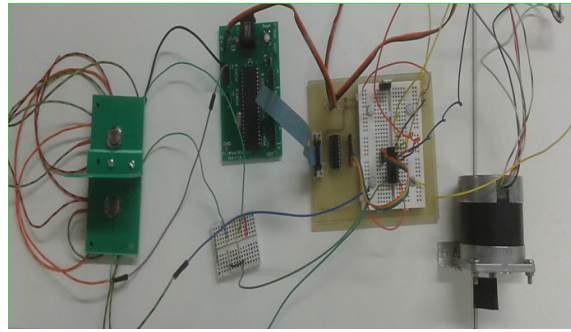

Fig.4. Interfacing LDR sensor and motors with PIC184520.

### b) Design Solar Shade System (SSS)

The hardware of building ABISS gives a clear picture of how the system was built and all the necessary processes in connecting different parts of the design as shown in Fig.5.

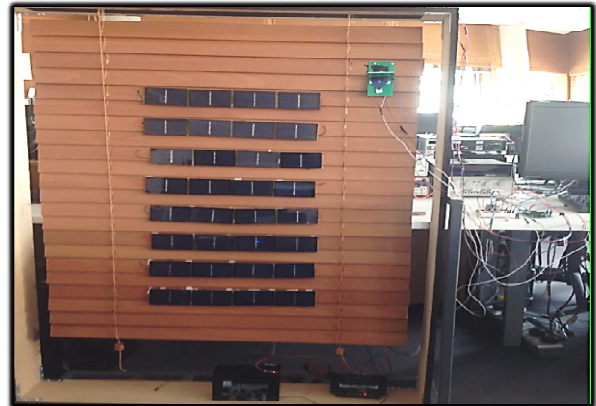

Fig.5. Design Solar Shade System (SSS).

The selected stepper motor has been chosen according to some calculation starting by: the step angle  $7.5^\circ$  is obtained from the stepper motor datasheet which can be used to calculate the steps per revolution, as:

$$\text{Stepper Revolution} = 360^\circ / (\text{step angle}) \quad (1)$$

$$\text{Stepper Revolution} = 360^\circ / 7.5^\circ = 48 \text{ Step}$$

$$\text{Teeth ratio} = 1:48$$

The load torque to rotate the slats of the solar blind was calculated to choose the appropriate stepper motor using the formula below:

$$T_L = \frac{F_B \times D}{2} \quad (2)$$

Where is;

$F_B$  = Force begins to rotate main shaft ( $F_B$  = spring balance value  $\times g$ )

$g$ = Gravitational acceleration constant ( $9.8 \text{ m/s}^2$ )

The method used in this project to calculate the load torque shown in Fig.6.

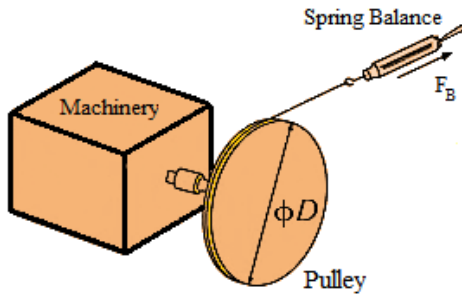

Fig.6. Load torque measurement [10].

The value for spring balance was measured, which is = 250g to calculate  $F_B$ ; therefor

$$F_B = 250 \times 10^{-3} \times 9.8 = 2.45 \text{ N}$$

The diameter of the pulley that is fixed in the main shaft of the solar blind is 2.7cm, as shown in Fig.7.

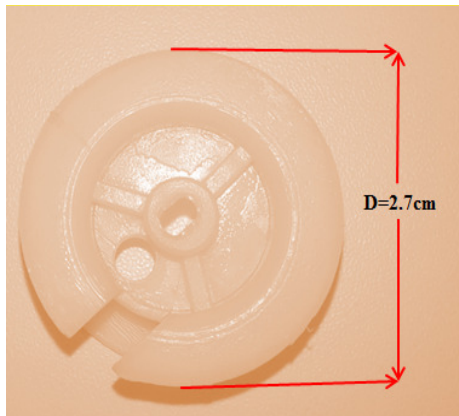

Fig.7. Pulley diameter.

The load torque can be calculated as follows

$$T_l = \frac{F_B D}{2} = \frac{2.45 \times 2.7 \times 10^{-2}}{2} = 0.033075 \text{ N.m} \rightarrow 33.075 \text{ mNm}$$

### 3. TESTING AND RESULTS

The ABISS was tested to evaluate the efficiency and its ability to track the sun as illustrated on Table 1 and Fig.8, the results of the test shows that  $V_{oc}$  and  $I_{sc}$  are approximately constant due to of the efficiency of the ABISS system.

Table 1. Testing ABISS system on Sunny Day

Time	3:00pm	3:15pm	3:30pm	3:45pm	4:00pm	4:15pm
------	--------	--------	--------	--------	--------	--------

$V_{oc}$ (V)	13.84	13.89	13.74	13.73	13.9	13.89
$I_{sc}$ (mA)	199	203	200	199	210	199
V with load ( $68\Omega$ )	12.78	13	13	12.9	13	13.05
P(W)	2.54	2.64	2.6	2.57	2.73	2.6
Light intensity (Lux)	6250	6060	6300	6300	6350	6340
Temperature ( $^{\circ}\text{C}$ )	23	23	23	24	23	24

The load used to measure the current in short circuit ( $I_{sc}$ ) was  $68 \Omega$ , and also to see what effect can happen to the output voltage of integrated PV, when the load is connected. As demonstrated in Fig.8 below, there was a slight drop in the voltage.

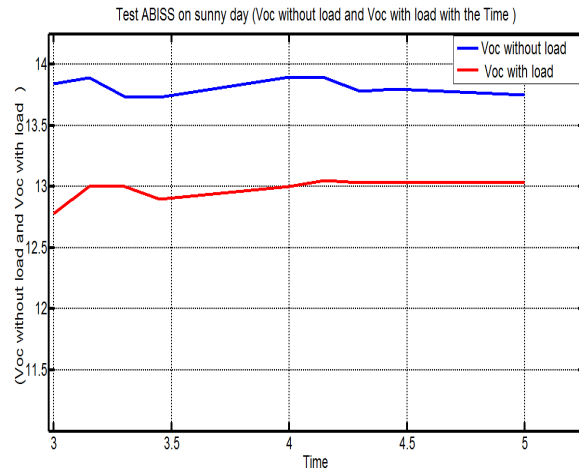

Fig.8. The effect of load on the output voltage of integrated PV.

The test was successful, where the system tracked the sun as required, based on the signals received from the LDRs and processed by the  $\mu$ controller. The table above illustrates that the readings of  $V_{oc}$  and  $I_{sc}$  are approximately constant as a result of the efficiency of the ABISS system.

### 4. CONCLUSION

In conclusion it can be stated that the purposes and objectives of this paper work were attained. Firstly, the Proteus software's design of the electronic circuit was successfully finished by interfacing the various sensors (LDRs and Hall Effect sensor) to the microcontroller, to save the consumption of energy PIC184520's sleep mode has been applied, and to wake up the PIC18F4520's after every 15 minutes so that the deference of the LDRs' value can be checked for setting the integrated PV in the position of the sun, the Real Time Clock or RTC was successfully used as an external interrupt. an automatic solar shade system was designed, including making a wood frame to carry the window blind, mounting the stepper motor into the frame for rotating the integrated PV panels (slats).

## REFERENCES

- [1]. Balzani, V., and Armaroli, N.– Energy for a sustainable world: from the oil age to a sun-powered future. John Wiley & Sons. 2010.
- [2]. Kuthanazhi, V., Kottantharayil, A., and Narayanan, N. C. ., – Planning for integration of solar photovoltaics into the energy needs of villages through local self-governments: An experience in the state of Kerala, India. In 2014 IEEE 40th Photovoltaic Specialist Conference (PVSC), 2014, pg. 1452-1457.
- [3]. Rong, Y., Chen, L., and Cui, M. - A new maximum power point tracking scheme for building integrated photovoltaic systems. In 2013 Third International Conference on Instrumentation, Measurement, Computer, Communication and Control. Sept, 2013. pg. 622-627.
- [4]. Bidram, A., Davoudi, A., & Balog, R. S. - Control and circuit techniques to mitigate partial shading effects in photovoltaic arrays. IEEE Journal of Photovoltaics, 2(4), 2012, pg 532-546.
- [5]. Santos, P., Vicente, E., and Ribeiro, R. - Reconfiguration methodology of shaded photovoltaic panels to maximize the produced energy. In XI Brazilian power electronics conference, Sept, 2011. Pg. 700-706.
- [6]. Veerasamy, B., Kitagawa, W., and Takeshita, T. - MPPT method for PV modules using current control-based partial shading detection. In 2014 International Conference on Renewable Energy Research and Application (ICRERA2014), Oct 2014, pg. 359-364.
- [7]. Sharma, P. and Agarwal, V. - Exact Maximum Power Point Tracking Of Grid-Connected Partially Shaded PV Source Using Current Compensation Concept'. IEEE Transactions on Power Electronics 29 (9), 2014, pg. 4684-4692.
- [8]. Milad W, Sulaiman S, Esdeira A, and Emhemed A., - Experimental Study of Power Characteristic for Photovoltaic and Wind Turbine, International Journal of Information Technology and Electrical Engineering, 8(1), 2019, pg. 18-22.
- [9]. Mahjoubi A, Global Solar Radiation in Two Tunisian Cities: Comparison of Prediction and Measured Data, Journal of Sustainable Energy, 9(2), 2018, 69-76.
- [10]. www.orientalmotor.com