

SCENARIOS OF REGIONAL POWER SYSTEM EXPANSION FROM SOUTHERN OF BIHOR COUNTY BASED ON THE EXPLOITATION OF RENEWABLE ENERGY SOURCES

IAS G.I. *, LOLEA M.S.*, MINDA A.A.**

*University of Oradea, Universităţii no.1, Oradea,

**University "Eftimie Murgu" of Reşiţa, Traian Vuia Square, no.1-4, Reşiţa

iasgeorge@yahoo.com, a.minda@uem.ro

Abstract - The paper relates to the analysis of the local RES potential for the installation of power plants to allow for the extension of the regional power system for a site located in the southern part of the Bihor county, in the perimeter and the vicinity of the cities of Vaşcău, Nucet and Ştei. There are highlighted aspects of the current state of regional valorisation of renewable energy resources and possibilities for interconnection and connection to the Power System (PWS), for the optimal supply of electricity to consumers. A comparative analysis of the advantages and impediments generated by the implementation of local energy projects based on RES, focusing especially on wind energy, is developed and presented. At the end of the paper are presented the recommendations regarding the opportunity of using the RES and conclusions resulting from the study underlying that work.

Keywords: Renewable Energy Sources (RES), energy consumers, energy projects, overhead power lines (OPL).

1. INTRODUCTION

In Romania, after the Revolution of 1989, many regions lost their economic and industrial significance during communism. In many areas of activity, such as energy, investments in large targets have diminished. After the European integration, Romania's economic growth began to be progressively significant.

However, some regions have failed to regain their economic prestige from another time. Among these regions is the one referred to in this paper. The analyzed area is located in the southern part of Bihor County, as can be seen in the image from Figure 1. In the context in which the industrial revival is still not present, the authors took into account an analysis of the potential use of the zonal RES, which through the advantages that they could give, both at the industrial level and at the level of the population, in this regard. Especially, the conversion of RES into electricity and less heat will be referred to as large projects are being analyzed to serve a whole community of locality or region that encompasses them. In the past there were large industrial energy consumers in the region who, due to political and economic circumstances, have disappeared or reduced their

activities. Among them were: Bihor mining Company with Băiţa Mine, Mechanical Factory for mining machines – Hiperion SA Ştei, Marble processing Company Vaşcău, Paints packaging Enterprise Ambarom SA Ştei, Woodworking factory for doors and windows Romobin SA Ştei and others [8].

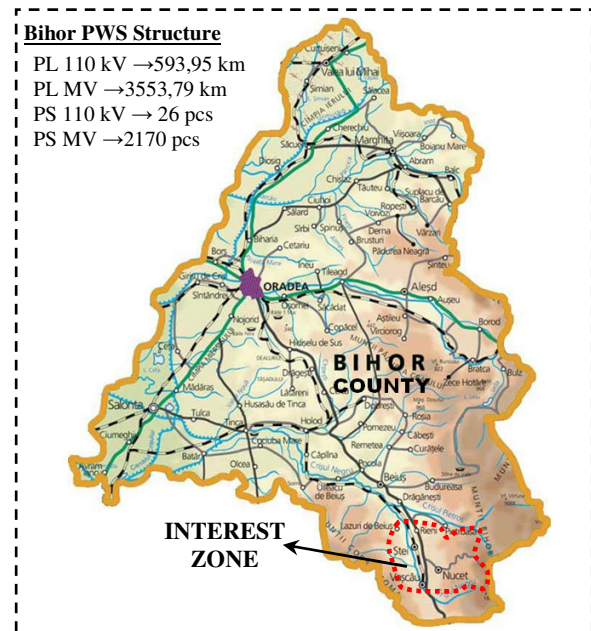

Fig.1. The location of the area of interest in the south of the county

The largest industrial consumer of electricity and heat in the analysis area is the European Food Industry Platform in the city of Ştei. Other large-scale consumers are made up of electromagnetic receivers in administrative buildings and in socio-cultural-educational or medically settings, public utility system such as water pumping stations, sewage treatment plants and street or architectural lighting. Existing companies with relatively high energy consumption are also the textile and bread factory Panimara S.A. of Ştei [10]. In the cities of Vaşcău and Nucet or in the communes from their perimeter there are companies with a few employees, generally less than 10, and the energy consumption per unit is relatively low [7]. The city of Sty is the center of gravity in terms of energy consumption, but also of demography or economic operators. Besides the cities of Ştei, Vascu and Nucet, in the analyzed region there are also included four communes with the belonging villages.

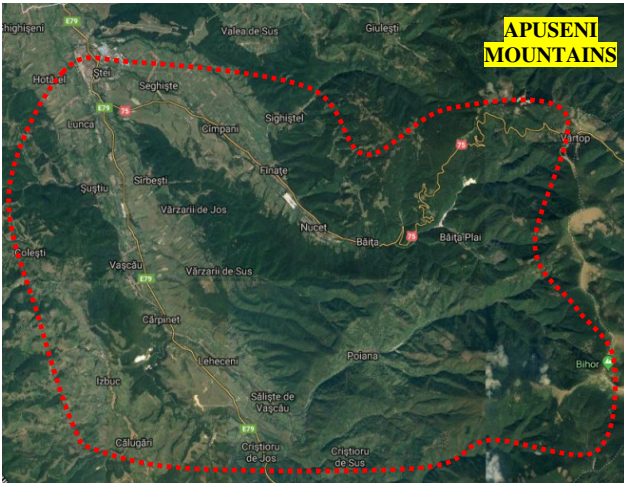

Fig.2. Territorial delimitation of Area of analysis

These communes are: Carpinet, Lunca, Câmpani and Criștioru de Jos. The southern and eastern boundaries of the region are made by the borders of the counties of Arad and Alba. The territorial delineation of the analyzed region is shown in Figure 2.

2. ACTUAL SITUATION OF LOCAL RES INTEGRATED IN THE REGIONAL PWS

There are several forms of energy considered renewable in terms of current technical applications [1][2][6]. In the paper are analyzed only those are most widespread on the territory of Romania, namely: wind energy, hydraulic energy, solar energy and biomass energy. Highlighting data on the energy potential of renewable sources stems from the authors' investigation of maps or databases published as printed or existing online on the intranet. However, before the decision to practice an energy project, because the published information is often different, it is recommended to carry out practical measurements of some characteristic quantities of each type of energy.

2.1. The regional Potential of RES

The presentation of the potential will be done on the four forms of energy presented, as follows:

a) Solar energy

Analyzing the map of the distribution of solar radiation in Romania [8], Bihor County can be characterized as follows: there is an extended region in the western part of the entire North-South alignment, which is included in the solar radiation zone II. In the middle region, also extended from north to south, there is the radiation zone III; In the south-eastern part of the county, in the area of the Apuseni Mountains, the IV and V solar areas are predominantly low (1200-1250 for zone IV and below 1200 kWh / m² / year for zone V).

As variations in solar radiation, the monthly range of values in Romania reaches the peak in June (1.49 kWh / m² / day) and the minimum in February (0.34 kWh / m² / day). Solar energy is used in two directions: thermal and photovoltaic. Solar thermal – energy according to [12] for Romania is: technical potential on 40 GWh /

year or 144000 TJ / year; economic potential on 17 GWh / year or 61200 TJ / year. Solar electric - energy according to [10] for national territory is: technical photovoltaic potential on 6 TWh / year; economic photovoltaic (PV) potential on 4,8 TWh / year. For the portion of interest there are three zonings from the point of view of the intensity of solar radiation. The solar radiation values are [10]: 1000 ÷ 1200 kWh / m² / year, which corresponds to higher mountain areas, 1200-1250 kWh / m² / year for low mountains area or high hills and 1250 ÷ 1300 kWh / m² / year for the depression zone and small hills area.

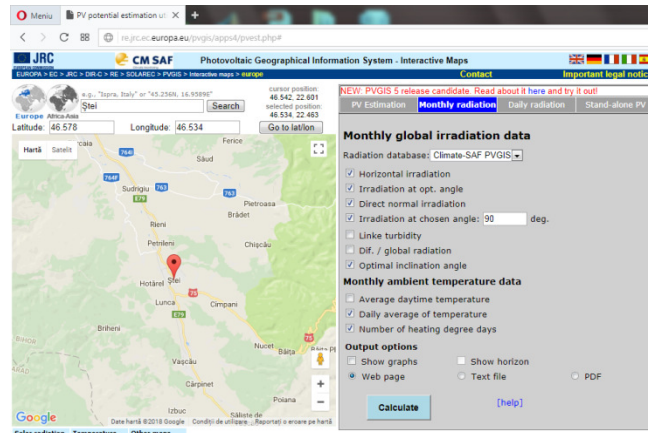

Fig. 3. Photovoltaic geographical information for an interest place(Ștei)[16]

The simulations made by the paper authors for the cities and communes in the area analyzed with the SOLAREC Platform, led to the following results: Ștei - 1270 kWh / m² / year, Vașcău - 1260 kWh / m² / year, Nucet - 1220 kWh / m² / year, Cârpinet - 1150 kWh / m² / year, Criștior - 1240 kWh / m² / year, Lunca - 1270 kWh / m² / year, Câmpani - 1180 kWh / m² / year.

Month	H _t	H _{opt}	H(90)	DNI	I _{opt}	T _{24h}	N _{DD}
Jan	1010	1530	1510	1110	61	0.1	588
Feb	1700	2350	2110	1660	54	1.2	466
Mar	3200	4020	3150	3030	45	6.1	356
Apr	4450	4920	3080	4000	30	11.5	135
May	5240	5210	2710	4270	16	16.1	41
Jun	5740	5460	2570	4810	9	19.6	10
Jul	5670	5550	2700	4870	14	22.0	2
Aug	5240	5650	3230	5240	27	22.1	27
Sep	3610	4370	3180	3450	41	17.5	105
Oct	2570	3670	3280	3030	55	10.9	308
Nov	1410	2300	2350	1930	63	6.8	464
Dec	852	1330	1360	983	63	1.0	595
Year	3400	3870	2610	3210	34	11.2	3097

Fig.4. Information about monthly solar Radiation for an interest place-Ștei [16]

The potential of solar energy is highlighted based on the results presented in [12] but also by using the platform PVGIS (SOLAREC) of Joint Research Centre [16] – managed by the IET – Institute for Energy and Transport of European Commission. An example of

using this platform to assess the photovoltaic potential for a point in the area of interest is shown in the Figures 3 and 4.

b) Biomass

From the point of view of the biomass resources with available energy potential, the Bihor County is included in high average values in Romania. For the area of interest of the paper, wood - forestry biomass is predominant and very little agricultural, because the most widespread forms of relief are the hills and mountains [12]. If the forest biomass energy potential is appreciated as well as the Bihor County, it reaches an average value of 95,93 TJ in the area of interest compared to 4,07 TJ as the average value of the agricultural biomass potential[12].

c) Hydro - energy

The hydro-energetic micro-potential (groups below 10 MW) on the territory of Romania is characterized by the power and energy values that can be installed and produced [12]: the power as technical potential is 1100 MW and the economic potential of 400 MW; the electrical energy obtained has a technical potential of 3,6 TWh / year and an economic potential of 1,2 TWh / year. The area analyzed in the paper is included in the Crișuri catchment area with a total area of 13085 km² and a theoretical energy potential of 4,2 TWh / year and technical 2,2 TWh / year[12].

The local hydro-energy potential is given by the upper course of the Crișul Negru River, which is the largest flowing water in the analyzed region. This river springs from the Bihor Mountains and collects several smaller water courses. Thus, from the Bihor Mountains, the main affluents of the Crișul Negru River are the Baita River and the Sighiștel Stream. The affluents of the Crișul Negru River that originate in the Codru-Moma Mountains are mainly collected by the Boiu Basin: the Runlet Cristiorel, the Runlet Izbuc, the Țarinei Valley and the Valley of Briheni. The Figures 5 show an image of a local river near Stei City.



Fig.5. Băița river near Ștei City [10]

d) Wind energy

In some parts of Romania the wind energy potential given by its speed is very high. The evidence consists of the many wind turbines that have appeared in recent years especially in the south-eastern part of the

country and which in terms of dynamics have led Romania among the top 10 in the world – on year 2014- as power installed in wind power plants[19].

A major energy project based on wind energy has also developed in the analyzed region, meaning that there is sufficient potential. A regional section taken from the Romania Wind Map exposed in [12], is presented in the next figure. From Figure 6, the following statements can be made: there are 5 distinct wind potential areas; no location within the area of interest is included in the maximum potential; between these areas the wind speed ranges from 3 to 10 m / s. The highest wind speed is in the peak of the Bihor Mountains at about 1850 m altitude. The largest surface in the area of interest is within the wind speed range of 4-6 m / s.

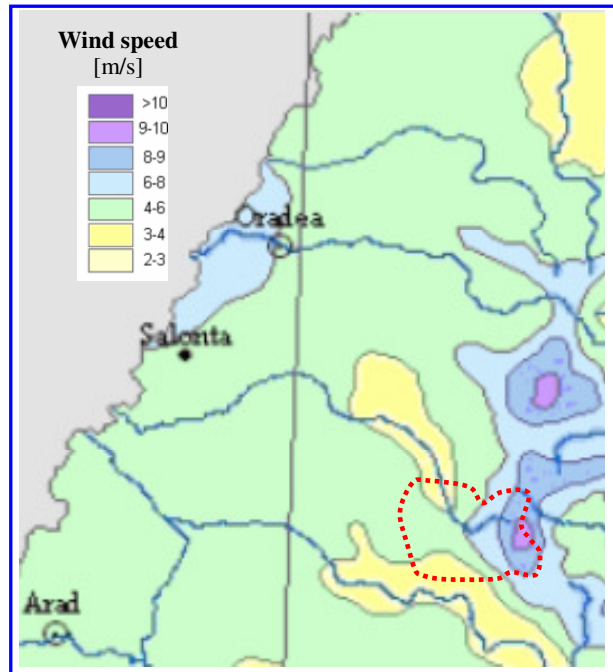

Fig.6. Regional Wind Map [12]



Fig.7. Wind turbines on Curcubăta Mare peak from Apuseni Mountains

2.2. Conducted projects

Not many energy projects in the analysis area are finalized or / and achieved in practice[15]. These are: the wind power farm (11,5 MW) located on the Peak of Bihorul in the Apuseni Mountains, the Poiana 1(0,53

MW) and Poiana 2(0,237 MW) hydroelectric installations on the upper course of the Crișul Negru River(fig.8) and the Lunca photovoltaic site(4.1 MW)[15]. There are possibilities for evacuating the electric power from the existing power plants in the analyzed area due to existing electric substations and power lines which also have a relatively high degree of interconnection. There is the possibility to interconnection with the rest of the PWS through local power objectives as in the case presented in Figure 9.



Fig.8. Hydraulic plants at Poiana/Cărpinet, on river Crișul Negru

There are three electric substations in the area built in localities Nucet (Băița Plai), Ștei and Vașcău. Their construction was justified by the electricity supply of the localities in the area with multiple categories of household or public low-power consumers, but also for the large industrial consumers that existed in the past.

Near these electric substations, but located outside the area of interest, yet interconnected by 110 kV overhead power lines, there are the substations Sudrigiu and Vârfurile. Existing overhead power lines have the

possibility of transporting electricity to the rest of the county.



Fig.9. OPL d.c. 110 kV Oradea – Beiuș - Vașcău

That is why major investments must be made in the installation of new power generation capacities. Careful consideration should be given to the possibilities of connecting to the Power System - PWS connecting points and to the loss of power and energy or its own technological consumption. Even if there are load capacities in new RES - based plants, evacuation installations require serious investment.

2.3. Description of the Wind Farm Curcubăta Mare-Avram Iancu

The largest project and energy objective achieved in the field of wind energy in Transylvania is the wind farm Avram Iancu. That is why we consider it appropriate to give it a special paragraph intended for this work, as an example to follow based on the dictum: "if you want to you can do". An image of the turbines in the analyzed wind farm was presented in Figure 7.

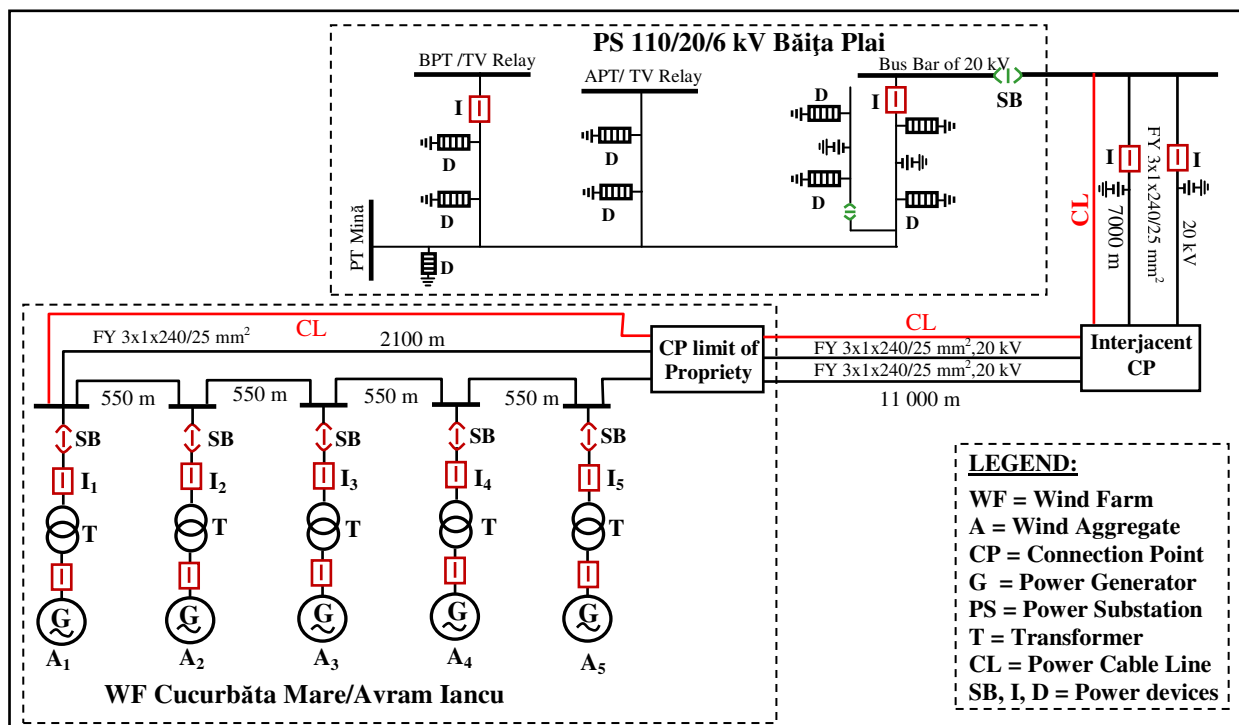

Fig.10. Scheme of Băița Plai PS (adapted from [11])

Scheme of framing in regional PWS of Wind Power Plant is shown in Figure 10. On scheme are noted some technical details of interest. The reference wind farm is located on the tip of Curcubăta Mare (1849 m), from the Bihor Mountains on the territory of Avram Iancu commune in Alba County. The project was co-financed by European funds with a total value of almost 25 million euro. The investment is carried out and carried out through the company Energo Proiect SRL from Cluj-Napoca, which received a partial financing of about 18 million euro through the Sectoral Operational Program "Increasing Economic Competitiveness"[14].

The installed capacity of the plant is 11.5 MW in 5 wind turbines manufactured by VESTAS Denmark with unit power of 2.3 MW operating at a voltage of 0.69 kV. Electricity evacuation is done by underground cable at the medium voltage level and the connection to the regional energy system is made by the electric station (ES) Băița Plai. Monitoring the energy parameters is done by a micro-SCADA system with a controller located at a control point in the vicinity of the wind farm.

3. POSSIBILITIES OF REGIONAL PWS ENLARGEMENT BASED ON THE USE OF RENEWABLE ENERGY SOURCES

For setting up scenarios, account is also taken of existing electrical installations such as PS(Power Substations) and HV-OPL (High Voltage – Overhead Power Lines), as well as the possibility of developing new ones as needed. For local power substations (PS), also the authors consider that they are sufficient to take on possible loads by discharging from power plants or feeding consumers. Regional power substations have been designed to supply more local consumers, but they are no longer functioning for various reasons. One of the existing industrial consumers is Company European

Food SA Ștei, but its main power supply is made from a private PS located in the locality of Sudrigiu.

For the viability of a local power system extension, the authors propose the schemes of Figures 12 and 13 that are compared to the current situation outlined in Figure 11. On the figures for the presentation of the regional PWS variants, the technical details of the networks, including the distances between the OPL connection points. The proposed schemes take into account several technical - economical parameters and including continuity in the power supply consumers and the reliability of the energy system. Possibilities for additional location of extended solar parks on relatively more flat surfaces are: between Câmpani and Ștei; between the localities of Vașcău and Cărpinet; between the localities of Cărpinet and Cristior.

The wind speed in the area of Bihor Mountains allows and requires the installation of additional wind turbines, especially since the available land area allows for this. For each OPL configuration and equipment, the following issues should be considered and resolved optimally[3][4][5][8]: ensuring the electricity supply to consumers; ensure selectivity, sensitivity and coordination of relay protection; identify and implement the most appropriate layout schemes; reducing energy losses; reducing the own technological consumption; increase the reliability of consumer energy schemes; increasing the quality of electricity; choosing and purchasing equipment; training inventory of equipment and work materials; electromagnetic compatibility; reduced operating risks. The location of the power plants based on RES, according to the authors' proposals is shown in Figure 14. We believe that the best solution for the location of a biomass plant to produce both heat and electricity will be near City of Nucet. This is justified by the proximity of the exploited wood resources in the Bihor Mountains.

Table 1. Multi-criterion analysis of wind energy utilization for the region

Criteria	Advantages	Weaknesses	Opportunities	Downsides
Real wind potential	Higher wind speed, which recommends the installation of wind turbines (6-10 m/s).	Limited access to wind potential areas and/ or problems relating to the entry of land for the installation of wind-generating capacities (the opposition of land owners in the area of reference belonging to communes and neighboring cities: Câmpani, Nucet - BH, Arieseni, Avram Iancu - AB)	Vicinity of connection facilities at National PWS (PS Ștei, Vascau, Baita Plai, OPL 110 kV Oradea - Vascau) Possibilities of investment subsidy in the field with multiples funding sources: government, European Union, public-private partnerships, private ones. Possibilities to expropriate the necessary land by buying, renting, living life or shareholding through dividends, tax exemptions, garbage power, compensation with other land in the area of administration of the local council.	Bureaucracy, the lack of regional companies with an object of activity in the field, Opposition by ornithologists and other endemic animals.
Technical arranged potential	The functionality of wind turbines on Bihorul peak of 5 x 2,3 MW / unit.	Inaccessible roads during the winter.	Creation of jobs, electricity supply to the region, existence of the evacuation grid, green and clean energy.	Lack of specialists and possibilities of remediation of incidents and damages in a reasonable time, the impossibility of accessing the operational information due to exploitation monopoly, a high degree of exposure to vandalism.
Delivered energy	Small production price with trading on the stock exchange at an average of 48,65 euro/MWh(2016).	A long route of electricity evacuation (aprox.11+7 = 19 km) that predisposes to voltage drops, frequency fluctuations, difficulties in identifying defects on continuity of evacuation.	Suppliers interested in buying and selling cheap energy from a local wind source, materializing production in green certificates.	Consumers mistrust in unconventional energy, high costs associated with replacing existing system components with repercussions in energy costs.
Regional consumers	Many domestic and industrial applicants.	No connections for isolated or newly established consumers.	The quality of electric energy ecologically produced, the existence of redundancy, the speed in the repair of incidents and damages.	Unclear about the choice of the energy provider

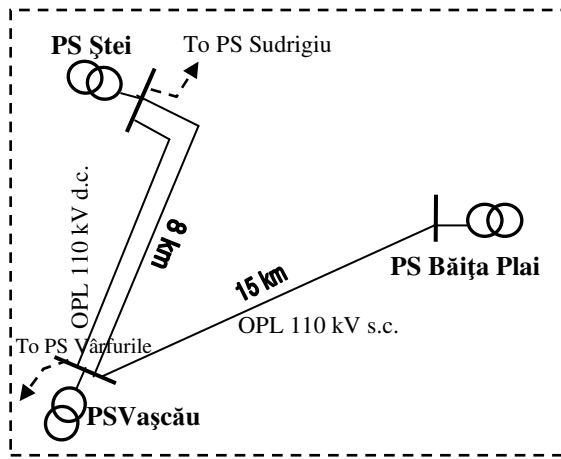

Fig.11. Interconnection of PS Ștei – Băița – Vașcău (Actual status)

Because the wind farm described is currently the one with the largest capacity to produce electricity in the region, Table 1 presents a multi-criterion analysis of the implementation of energy objectives based on the conversion of wind energy. The comparative analysis from the tables is adapted to local conditions.

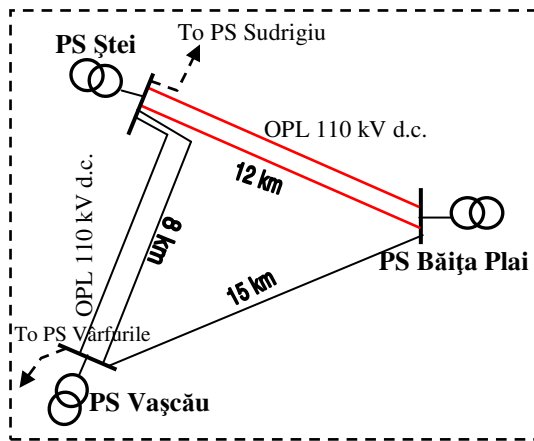

Fig.12. Interconnection of PS Ștei – Băița – Vașcău (Scenario I)

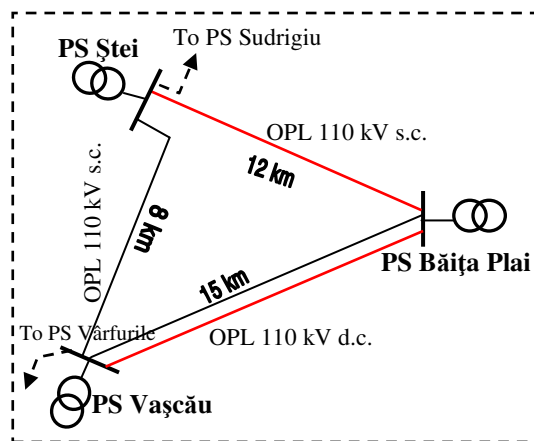

Fig.13. Interconnection of PS Ștei – Băița – Vașcău (Scenario II)

On the figures for the presentation of the constructive variants of the regional electric power system are noted some technical details of them including the cases between the three electrical connection stations.

The thermal energy can be used for centralized heating of buildings in the town and electricity will be injected into the public grid by taking advantage of the proximity to Băița Plai power substation. The installation of photovoltaic farms can be done in the vicinity of each commune or city in the analyzed area because there is the necessary and appropriate land. There will be electricity that can be used for street lighting and public buildings supply. The micro-hydro power stations can be located along the rivers Crișul Negru, Băița and Sighiștel, in addition to the existing ones. We propose their location in the neighbourhood of Fânațe, Sighiștel and Șuștiu. Wind farms can be located in the vicinity of Sighiștel and Călugări, in high hills and mountains.

The evacuation of the electric energy from the power plants on 20 kV voltage level is as follows: at PS Băița Plai → Bihorul peak (wind farm), Poiana 1 and 2 (hydro plants); at PS Ștei → Lunca (PV site).

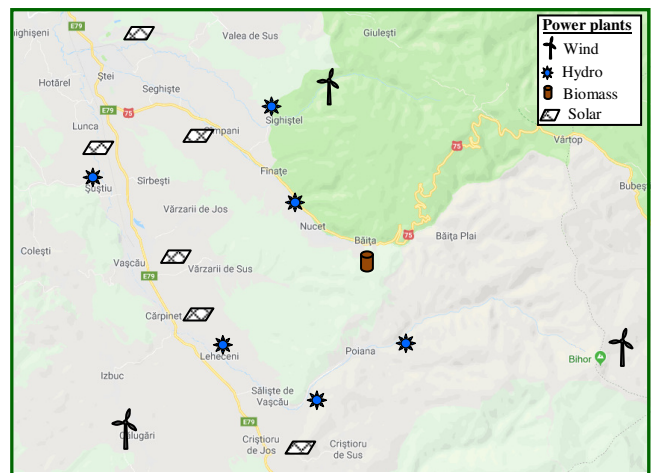

Fig.14. Map of RES Power Plants

The development projects of the regional energy system also involve the realization of a vast network of electricity distribution installations on medium and low voltage levels. In this case, the problem of active power and active energy loss, in particular, begins to become more and more serious [3][4][8][9]. The evaluation of the power and energy losses in the elements of the distribution grids (lines and transformers) can be achieved by repeated mode calculations, considering in the network nodes the active and reactive daily load curves, modeled in the form of time steps (t). Energy losses over the range proposed for analysis are determined by summing up the hourly power loss $\Delta P_{l,j}$. Thus, the daily energy losses ΔW , on any element of the network l_j , can be calculated with the relation [4]:

$$\Delta W_{l,j} = \sum_{t=1}^{24} \Delta P_{l,j}(t) \quad (1)$$

To assess energy losses over a longer period of time, it is necessary to analyze the monthly regimes throughout the years of analysis. A local power system must have the ability to drive through the dispatcher, the possibility of electrical islanding, and a high reservation rate to be ensured by connecting to the neighbouring electrical grids and, implicitly, to the PWS to which it belongs [8].

To highlight the advantages and disadvantages of implementing a regional energy system in the area of interest, a SWOT analysis of RES exploitation will be presented in Table 2. The final validation must take into account the local energy resources and the financial profitability of such objectives. By way of comparison, the RES maximum potential for three territorial levels is presented in Table 3.

Table 2. Regional RES exploitation – a SWOT analysis

Ratings	Capitalization characterization of regional RES
Strengths	Cooperation between local administration, local agencies and traders; Contribution of the University of Oradea to scientific and applied research and creation of specialization in RES; Development projects of the localities in the interest area, in cooperation with neighboring regions.
Weaknesses	Lack of current research into the potential of renewable energy; Failure to implement clear local and regional strategies for the use of renewable energy; Poor interaction between research and the private business sector; Minimum public and private spending on research and development; Poor utilization of renewable energy resources.
Opportunities	Need for pilot projects in the field; Attractive investment climate for foreign and domestic investors; External financing programs for renewable energy business; Financing programs - research and technology transfer centers; Implementation of the national energy strategy with targets in 2020; granting green certificates to encourage the production of electricity to be provided on the public power grid.
Threats	Large and complicated legislation; Excessive bureaucracy; Chronic government sub-financing in research, innovation and technology; The banking system hesitant about the investments in the field; lack of qualified human resources; lack of large industrial energy consumers; Absence of adequate support at county level and concrete measures in RES domain..

Table 3. RES potential levels – a comparative analysis

RES values RES type	Comparison of energy potential		
	Regional level (technical)	County level (technical)	National level (technical)
Wind speed	9-10 m/s	4-6 m/s	>10 m/s
Biomass	35,3 TJ/year	101,9 TJ/year	835,9 TJ/year
Solar rad/m ²	1200 kWh/an	1300 kWh/an	1400 kWh/an
Hydro	0,9 TWh/year	0,9 TWh/year	3,6 TWh/year

The assessment of the feasibility of electricity grid extension projects must take into account the cost - benefit ratio and meet the following financial assessment criteria based on technical aspects of the exploitation [3]:

- Criteria of minimum of Total Updated Expenses - TUE, which implies an estimate of the total up-dated

expenditure on the construction and operation of an investment objective.

$$TUE = \sum_t \frac{E_t}{(1+u)^t} \quad (2)$$

Where: t is duration of study;

E_t – Expense from year t[lei/year]

u – update rate [%/year]

- Criteria of maximum of Net Updated Value(cash income) – NUV. The criterion compares the updated amounts of future income and expense from the operating period to the amount of the initial investment:

$$NUV = \sum_t \frac{V_t - E_t}{(1+u)^t} = \sum_t \frac{M_t}{(1+u)^t} \quad (3)$$

Where: V_t – Value of cash income from year t[lei/year];

E_t – Expense from year t[lei/year];

M_t – money flow from year t;

t – Duration of analysis.

- Criteria of Internal Recovery Rate (profitability) - IRR. Is defined IRR for a proiect as being that update rate for which NUV = 0, resulting from the next equation:

$$NUV = \sum_t \frac{V_t - E_t}{(1+IRR)^t} = 0 \quad (4)$$

A project is promoted if it has $IRR > u_{normalized}$

In E_t are included investment costs too. Value of IRR is equal to the maximum gain rate that can be accepted without losses for the promoted project. Criteria of IRR take into account all relevant information.

In addition to the above mentioned aspects, which support or hinder the development of RES-based projects, there are also those risks that may reduce the predicted economic effect and which are taken into account by the financial institutions that support such projects. These risks are [5]:

- The political risk, generated by the executive and legislative leadership, which periodical changes the norms in the domain;
- Currency risk, stemming from political and economic instability by devaluing the national currency, reducing consumption, increasing inflation and purchasing power;
- Credit risk, arises as a result of the beneficiary's inability to pay for the amount of energy supplied or the reduction in electricity demand;
- The risk of implementation that may occur as a result of external events or causes that may impede project execution, including the causes of majeure force.

4. FINANCING FUNDS FOR ENERGY PROJECTS BASED ON RES

The realization of electric and thermal power plants involves particularly high costs, especially when they do not operate independently and isolated. The evacuation of electricity through the coupling of power plants to the PWS requires work to expand public power grids. For example, the authors of the paper have identified from the experience of some companies in the field that,

depending on the complexity, the estimated costs of achieving an OPL reach today to 170000 RON / km at MT level, respectively 300 000 Euro / km, for HT (case of OPL by 400 kV – single circuit).

As the origin, the capital sources for investment for energy projects are of two categories: national and foreign. National sources include budget allocations, self-financing and the internal capital market. External sources are the Trans-European Cohesion and Trans-European Integration Programs, the international capital market and foreign direct investment [5]. The local communities in the area under consideration do not have the amounts needed to implement large-scale energy projects and should therefore apply to attract additional government or EU funding. The sources of funding for RES domain research & developing projects, active at the time of the study for this paper, include [13] [18]:

- National Program for Rural Development(NPRD) 2014-2020;
- Operational Program for Great Infrastructure(OPGI) 2014-2020,
- Operational Program for Competitively 2014-2020;
- Operational Regional Program(ORP) 2014-2020;
- European Horizon 2020 Program;
- Cross-border Development Program INTERREG Romania - Hungary RO- HU.

As well as supporting investment initiatives on national programs coordinated by the Regional Development Agencies, the area of interest is placed in the North-West Development Region of Romania. The supply of electricity from RES to the public network also complements the obtaining of green certificates by producers that can be used on the market. Following the market for green certificates on the web platform presented in [17], we can see the following: for a transaction day (21.08.2017) a green certificate was valued at 132.0295 RON; on the inside daily market, the electricity obtained from the RES is traded on the same day, for example with a maximum of 198.29 RON / MWh; this means a price increase of 66.58% resulting in 330.3195 RON/ MWh, which is a very beneficial thing for the RES electricity producer.

6. CONCLUSIONS

Investment projects from the energy domain are generally included in the category of large or very large infrastructure objectives. The capital involved has high values and is recovering over a long period of time. When the RES is concerned, energy efficiency is increased and the costs of primary resources and energy production are reduced. The options for achieving RES-based energy objectives are possible in the long term provided the demand for electric and thermal energy in the analyzed region increases. This is possible with the emergence of new industrial consumers, but also with the increasing demands of the population for thermal comfort, ergonomics and quality of life. The mentioned aspects are complemented by evidence of the finishing of fossil fuels and the need to protect the environment in support of sustainable development. In addition to the

direct connection of rural localities to National Energy System, there are also alternative solutions to supply electricity and heat to consumers in this area. It is the case of decentralized energy production through hybrid energy systems. We recommend the introduction of a realistic energy strategy that includes the use of RES in the development plans of the cities and communes in the area, because they are lacking, by consultation and with the assistance of specialists with expertise in the field.

REFERENCES

- [1]. Bălan, M.C.- *Energii regenerabile*, Editura U.T.Press Cluj-Napoca, (2007).
- [2]. Caisin S , Şveţ Aurelia, Halaim Natalia - *Surse de energie regenerabilă*, Suport didactic, Ed. Bons Offices, Chişinău, (2014).
- [3]. Comănescu G s.a.- *Partea electrică a centralelor şi staţiilor*. Noţiuni privind alegerea soluţiilor optime pentru instalaţiile electrice, Ed.Electra, Bucureşti, 2006, <http://cceei.energ.pub.ro>;
- [4]. Iacobescu Ghe., Iordănescu I., Tudose M. – *Reţele şi sisteme electrice*, Ed. Did şi Pedagogică, Bucureşti, 1979;
- [5]. Lecca A s.a - *Managementul energiei*, Ed. AGIR,Bucureşti, 2008.
- [6]. Nagothu K. S., Arroju M , Maheswarapu S - *A novel approach to sustainable Power System Expansion planning with inclusion of Renewable Energy*, IEEE 7th International Power Engineering and Optimization Conference (PEOCO), pp.535-539,(2013).
- [7]. Praşca Mariana Lenuţa - *Dezvoltarea oraşelor monoindustriale mici. Studiu comparativ Nucet -Vaşcău*, Teză de doctorat, Universitatea din Oradea, 2013;
- [8]. Suslov K, Voropai N et.al. – *Expansion planning of active power supply systems*, IEEE PES Innovative Smart Grid Technologies Conference Europe, pp.1-5, (2017).
- [9]. Şotri S. – *Transportul şi distribuţia energiei electrice*. Ed. Domino, Târgovişte, 1996;
- [10]. *** *Strategia de dezvoltare locală a oraşului Ştei*, judeţul Bihor, pentru perioada 2014-2020, Elaborată de primăria oraşului cu suportul Romactiv Bussines Consulting, 2015;
- [11]. *** *Raport final de realizare al Proiectului Amenajare parc eolian Curcubăta – cod SMIS 20684*, Energo Proiect SRL, Cluj Napoca, 2016, web souce: <http://enpr.ro/wp-content/uploads/2016/08/15.-SMIS-20684-Raport-FINAL-al-proiectului.pdf>;
- [12]. *** *Studiu privind evaluarea potenţialului energetic actual al surselor regenerabile de energie în Romania*. www.minind.ro/domenii_sectoare/energie/studii/potential_energetic.pdf, (2006).
- [13]. ***<http://www.greenpeace.org/romania/ro/campanii/schimbari-climatic-energie/publicatii/surse-finantare-2014-2020>;
- [14]. <https://alba24.ro/parc-eolian-de-25-milioane-de-euro-in-muntii-apuseni-la-peste-1800-m-altitudine-investitie-initiata-de-un-asociat-al-lui-silviu-prigoana-445055.html>
- [15]. *** http://indesen.ats.com.ro/baza_date/sre.php;
- [16]. ***<http://re.jrc.ec.europa.eu/pvgis>;
- [17]. ***www.opcom.ro.
- [18]. *** <http://www.inforegio.ro/>
- [19]. ***www.schoenherr.eu/uploads/tx_news/download_wind_energy_report_romania_2014.pdf