

CONTROL METHOD FOR PARAMETERS COORDINATE MATCH OF FLUTED ROLLER FERTILIZER APPARATUS

/

外槽轮施肥参数协调匹配控制方法

Huimin Feng^{1, 2)}, Nana Gao²⁾, You Li²⁾, Weiqiang Fu³⁾, Yuming Guo^{*1)} ¹

¹⁾ College of Engineering, Shanxi Agricultural University, Taigu /China;

²⁾ Beijing Research Centre for Information Technology in Agriculture, Beijing /China;

³⁾ Beijing Research Centre of Intelligent Equipment for Agriculture, Beijing /China

Tel: +86-0354-6286869; E-mail: guoyuming99@sina.com

<https://doi.org/10.35633/inmateh-60-24>

Keywords: Control method, nearly-optimal set, exposure length, rotational speed, fluted roller apparatus

ABSTRACT

To improve the fertilization accuracy and distribution uniformity of nitrogen fertilizer, control method of working parameters coordinate match was proposed in this paper. Take minimum coefficient of variation as criterion, the nearly-optimal set of exposure length and rotational speed was solved based on regression models with known values of target fertilizer amount and operating speed, the interfaces were built to rapidly calculate related parameters. The static and dynamic experiments were conducted to verify the reliability and accuracy of regression models and control method; the results showed that under static conditions, the biggest difference value of fertilizer amount is 0.22g per revolution; under dynamic conditions, the deviation of fertilizer amount is less than 4.01%, the maximum deviation of rotational speed is 2.74%. Those results indicate that the control method is practical and feasible for fertilization operation.

摘要

为提高施肥作业精度和肥料分布均匀性,提出了一种基于目标施肥量和作业速度的排肥器开度和转速协调匹配控制方法。以各行排肥量一致性变异系数最小为优化准则,根据回归模型求解已知目标施肥量和作业速度下近优的排肥器开度和转速组合,并搭建了静态和动态测试界面。通过静态和动态试验对回归模型和控制方法进行了验证,静态条件下,最大排肥器单转排量偏差为0.22g;动态条件下,施肥量偏差均小于4.01%,马达实际平均转速与模型计算转速最大偏差为2.74%。结果表明本控制方法实用可行。

INTRODUCTION

Topdressing fertilizer application of a certain amount of nitrogen is essential for winter wheat. Nitrogen fertilizer plays an important role in nutrient accumulation and yield improvement for winter wheat during growing period (Efretuei A et al, 2016), adequate and uniform distribution of nitrogen topdressing fertilizer is the key to balance nutrients absorption for crops.

As the core implement mechanism of fertilization machinery, fluted roller fertilizer apparatus (Botao Wang et al, 2017; Qingzhen Zhu et al, 2018) is being widely used to achieve variable fertilization by adjusting the rotational speed or exposure length of fluted roller. Extensive variable rate fertilization (VRF) studies on rotational speed control method was reported, electric motor (Rui Zhang et al, 2012), hydraulic motor (Liping Chen et al, 2008) and mechanical continuous variable transmission (Chunying Liang et al, 2013, Ning Su et al, 2015) were studied to replace chain transmission and precisely control the rotational speed. The optimal adjustment of parameters to obtained the minimum coefficient of variation (Gómez-Gil J. et al, 2009; Benjamin E. et al, 2019) is still a major challenge, bivariate real-time adjustment algorithm was carried out based on the fuzzy-PID control technology, to control exposure length and rotational speed simultaneously (Man Chen et al, 2016). Control algorithm based on fuzzy system was conducted to generate nearly-optimal bivariate control parameters of exposure length and rotational speed (Yuxue Gu et al, 2011).

¹ Huimin Feng, Ph.D.; Nana Gao, Ph.D.; You Li, Eng.; Weiqiang Fu, Ph.D.; Yuming Guo, Prof.

Nevertheless, in practical fertilization, with a certain fertilization requirement, the exposure length is normally pre-set, the fertilizer discharge rate is calibrated under fixed rotational speed, which apparently ignores the deviation caused by the difference between the fixed rotational speed and actual rotational speed.

Research on coordinate matching control method of exposure length and rotational speed of fluted roller was proposed in this paper, the relationship of those two factors with target fertilizer amount and operating speed was discussed, the flowchart was embedded in a vehicle terminal to verify the reliability of control method. The static and dynamic experiments based on this method were conducted to evaluate the consistency of fertilizer distribution.

MATERIALS AND METHODS

Precision fertilization system

The topdressing fertilizer applicator (Huimin Feng et al, 2018) for winter wheat was taken as research object. Working principle of precision fertilization system is shown in fig.1, tractor position information is real-time acquired and calculated by high precision Global Navigation Satellite System (GNSS) receiver. Then, the information is sent to vehicle terminal. The target speed of hydraulic motor is calculated by the terminal according to the operating speed and machine parameters, the real-time speed of motor is monitored by hall sensor and then the controller realizes closed-loop control of hydraulic motor speed through Proportional–Integral–Derivative (PID) algorithm, thus precisely controlling the rotational speed of distributing shaft.

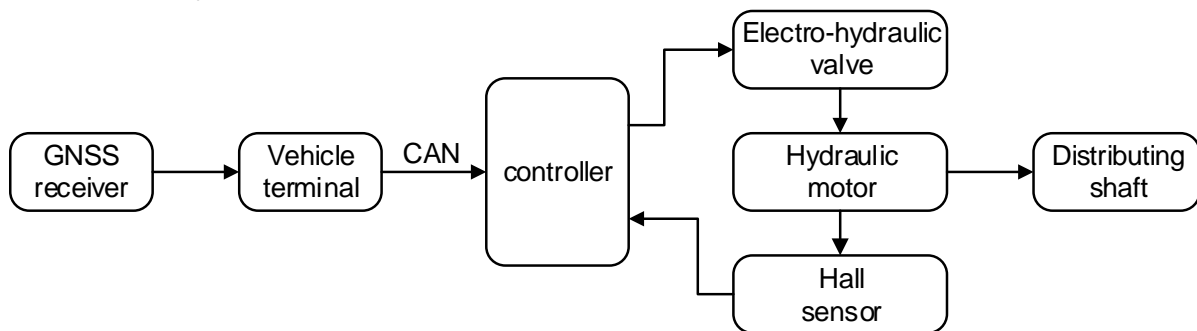

Fig. 1 - Schematic diagram of precision topdressing fertilization system

Structure of fertilizer apparatus

Circular-arc straight fluted roller fertilizer apparatus was taken as search object, as showed in fig.2, the number of grooves is 6, the radius of fluted roller is 25mm, the exposure length is the effective working length which is adjusted by spiral screw and adjustable wheel.

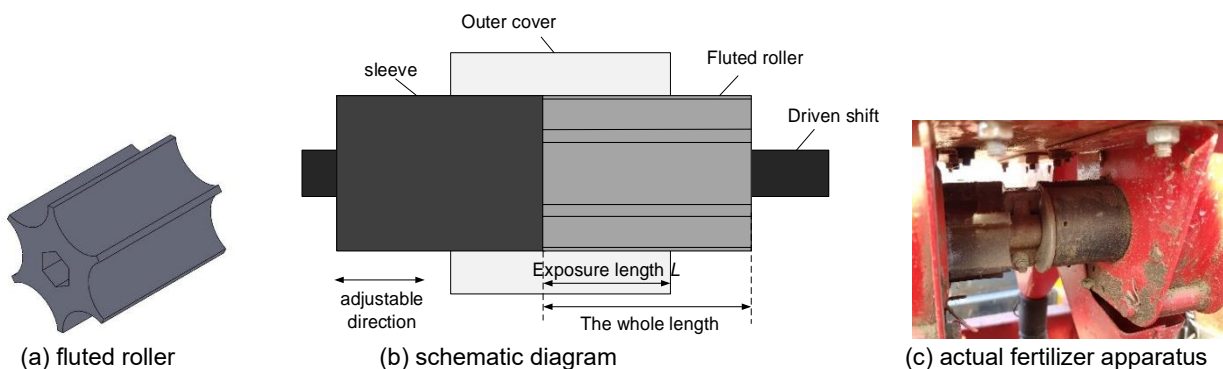

Fig. 2 - structure of fluted roller fertilizer apparatus

Fertilization model

Distributing shaft is connected with the hydraulic motor by a hexagonal shaft, so the speed of fluted roller is equal to the speed of hydraulic motor; the rotational speed of fluted roller was calculated according to formula (1), to realize real-time matching between the theoretical rotational speed R_0 of fluted roller and operating speed V of tractor.

$$R_0 = \frac{10 \cdot V \cdot W \cdot Q_0}{6 \cdot n \cdot q} \quad [\text{r/min}] \quad (1)$$

Where:

- W is operating width of applicator, [m];
- Q_0 is fertilizer amount per unit, [kg/hm²];
- n is number of rows;
- q is fertilizer discharge rate, [g/r].

Calibration of fertilizer discharge rate

The topdressing fertilizer amount of winter wheat is basically within the range of 80~350 kg/hm² (Zhongyang Huo et al, 2004), the settable range of exposure length L is 0~40 mm and 5~120 r/min for rotational speed R . The range of L and R in our study was decided based on previous tests and also the fertilization amount, which were 10~24 mm and 10~40 r/min, respectively.

The fertilizer discharge rate q is one of the key parameters for the fertilization models (Shiqiang Pan et al, 2016), static tests based on uniform fertilization were carried out to test the fertilization performance. Urea was selected as experimental material; the granularity scope of urea particles is 0.85~2.80 mm. The exposure length L was set at 10, 12, 15, 18, 20 and 24 mm with various rotational speed R of 10, 15, 20, 25, 30 and 40 r/min, the fertilizer discharged amount P by 7 synchronous fertilizer apparatus in one min interval was collected and weighed, respectively, and each test was measured with 3 replications.

The fertilizer discharge rate q and the coefficient of variation CV were calculated according to formula (2).

$$\left\{ \begin{aligned} q &= \frac{\sum_{i=1}^n P_i / n}{R} \\ S &= \sqrt{\frac{\sum_{i=1}^n (q_i - q)^2}{n-1}} \\ CV &= \frac{S}{q} \times 100\% \end{aligned} \right. \quad (2)$$

Control method

For fertilizer operating system, the variation of target fertilizer amount Q , fertilizer discharge rate q and coefficient of variation CV are all closely related to the change of exposure length L and rotational speed R . The relationship based on calibration data was analysed, as shown in fig.3; any fertilizer discharge rate q corresponds to infinite sets of exposure length L and rotational speed R along with various coefficients of variation CV , and for the target fertilizer amount Q as well, so the nearly-optimal set with minimum coefficient of variation can improve the fertilization accuracy.

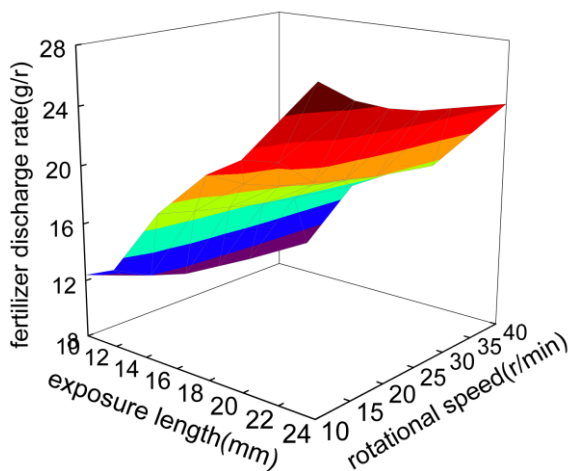

(a) Response surface of fertilizer discharge rate

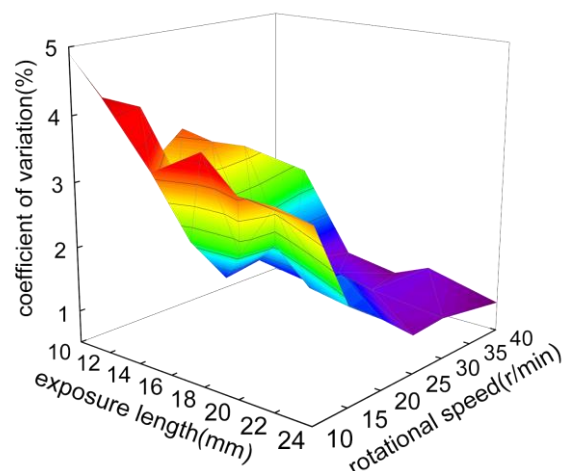

(b) Response surface of coefficient of variation

Fig.3 - Response surface based on calibration data

To find the nearly-optimal set of exposure length L and rotational speed R , the control method based on target fertilizer amount Q and operating speed V was proposed, this method consists of two parts: establish the models of fertilizer discharge rate q , coefficient of variation CV and target fertilizer amount Q with exposure length L and rotational speed R , then obtain the nearly-optimal set of exposure length L and rotational speed R by solving those models.

Method for solving nearly-optimal set

The flowchart of solving nearly-optimal set was shown in fig.4. In fig.4(a), the unique rotational speed was solved based on regression model $Q=F(L, R, V)$ with known values of target fertilizer amount Q , operating speed V and exposure length L ; in fig.4(b), the function of solving root was called as a sub-process to calculate the coefficient of variation CV and fertilizer discharge rate q based on regression models $CV=F(L, R)$ and $q=F(L, R)$. The nearly-optimal set was decided by the loop flowchart when the coefficient of variation CV had the minimum value.

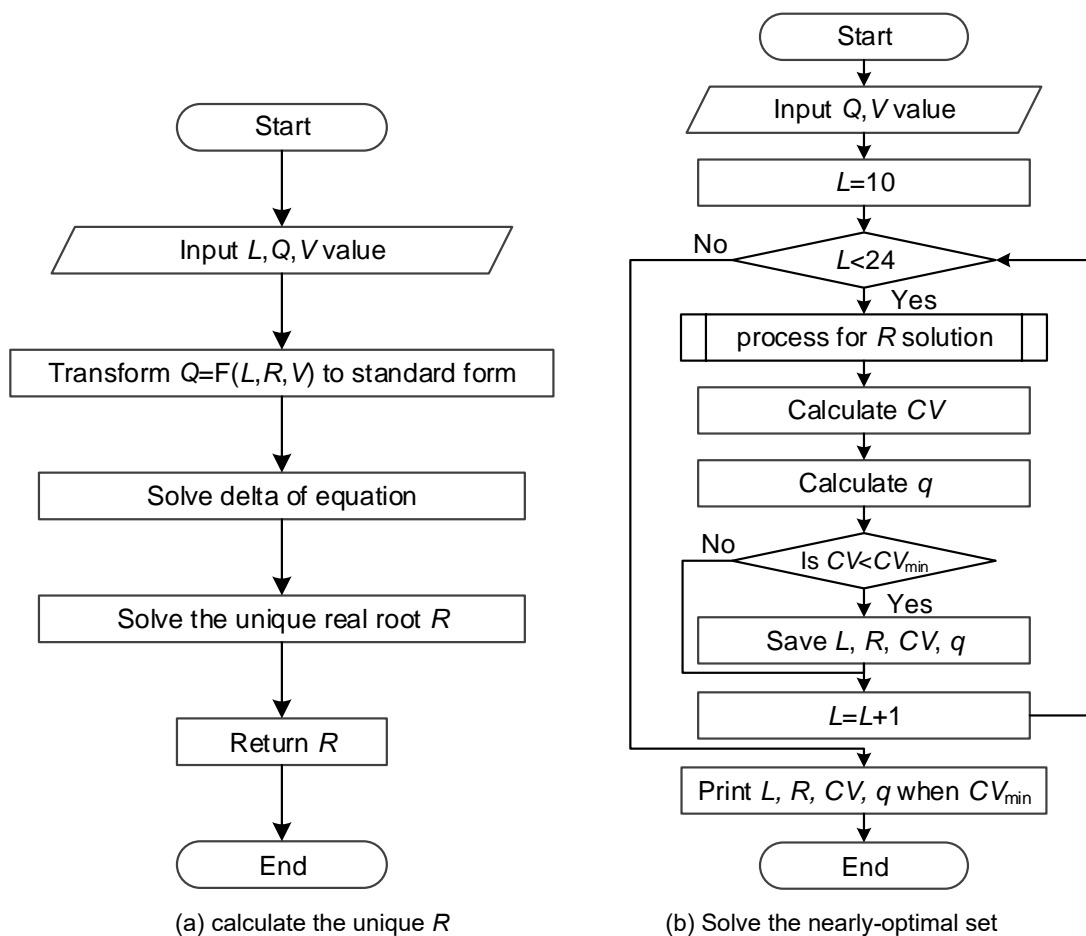

Fig. 4 - Flowchart for nearly-optimal set solution of exposure length and rotational speed

Regression models

Based on the calibration results and formula (1), the fertilizer amount per unit area Q at different operating speed can be calculated. The practical operating speed of topdressing fertilization for wheat is 3 ~ 6 km/h, a part of the related results at the operating speed of 3, 4, 5 and 6 km/h were summarized in table 1.

The range of Q is 40 ~ 600 kg/hm², which completely covers the range of topdressing fertilizer amount for winter wheat.

Table 1

Results of target fertilizer amount at different operating speed

L	R	q	CV	V ₃	Q ₃	V ₄	Q ₄	V ₅	Q ₅	V ₆	Q ₆
[mm]	[r/min]	[g/r]	[%]	[km/h]	[kg/hm ²]	[km/h]	[kg/hm ²]	[km/h]	[kg/hm ²]	[km/h]	[kg/hm ²]
10	20	10.75	2.95	3	143.33	4	107.5	5	86	6	71.67
12	20	11.35	2.84	3	151.33	4	113.5	5	90.8	6	75.67
15	20	17.05	1.49	3	227.33	4	170.5	5	136.4	6	113.67
18	20	19.3	2.21	3	257.33	4	193.0	5	154.4	6	128.67
20	20	20.05	1.71	3	267.33	4	200.5	5	160.4	6	133.67
24	20	25.60	1.55	3	341.33	4	256.0	5	204.8	6	170.67
10	25	10.40	3.42	3	173.33	4	130.0	5	104	6	86.67
12	25	11.04	3.31	3	184.00	4	138.0	5	110.4	6	92.00
15	25	16.52	1.58	3	275.33	4	206.5	5	165.2	6	137.67
18	25	18.64	1.45	3	310.67	4	233.0	5	186.4	6	155.33
20	25	19.56	1.69	3	326.00	4	244.5	5	195.6	6	163.00
24	25	24.92	1.09	3	415.33	4	311.5	5	249.2	6	207.67

Note: V₃ mean operating speed at 3km/h, Q₃ mean target fertilizer amount at 3km/h, and so on.

ANOVA analysis was performed to obtain the functional relationship between the exposure length L and the rotation speed R and their influence on the fertilizer distribution work, by analyzing the data in table 1.

According to fig.3, the response of fertilizer discharge rate q and coefficient of variation CV to exposure length L and rotational speed R showed a quadratic relationship, respectively. The factors which have significant impact on fertilizer discharge rate q will be taken as variables in the model of target fertilizer amount Q based on formula 1.

The factors effect on target fertilizer amount Q is consistent except that the coefficients in the models are inversely proportional to the operating speed; the regression analysis results at the operation speed of 3 km/h are shown in table 2.

Table 2

ANOVA of fertilization regression models

Responses	Sources	DF	SS	F value	Pr>F
q	model	5	974.63	279.31	<.0001**
	L	1	16.54	23.69	<.0001**
	R	1	3.94	5.64	0.0241*
	L*R	1	2.01	2.88	0.1
	L*L	1	0.005	0.01	0.9362
	R*R	1	4.370	6.26	0.018*
CV	model	5	36.00	35.93	<.0001**
	L	1	2.400	11.98	0.0016**
	R	1	5.130	25.59	<.0001**
	L*R	1	0.0034	0.02	0.8968
	L*L	1	1.39	6.92	0.0133*
	R*R	1	3.53	17.62	0.0002**
Q ₃	model	5	585050.6	516.26	<.0001**
	L	1	316.61	1.4	0.2465
	R	1	15.46	0.07	0.7957
	L*R	1	31206.48	137.69	<.0001**
	R*R	1	18.4	0.08	0.7776
	R*R*R	1	12.27	0.05	0.8176

Note: ** is extremely significant, P<0.01; * is significant, P<0.05.

Quadratic term R^2 has a significant effect on q and CV , Quadratic term L^2 has a significant effect on CV . The regression models were obtained based on the ANOVA analysis results, as shown in table 3; the determination coefficient of regression models for q , CV and Q were 0.979, 0.8569 and 0.9885, respectively.

Table 3

Regression models	
Regression models	R^2
$q = 2.2536 + 1.2033L - 0.2143R - 0.0006L^2 - 0.005LR + 0.0037R^2$	0.979
$CV = 10.5153 - 0.4584L - 0.2446R + 0.0098L^2 + 2.0822 \times 10^{-4}LR + 3.3476 \times 10^{-3}R^2$	0.8569
$Q = (-31.6916 + 4.8096L + 5.2035R + 1.885LR - 0.246R^2 + 0.0027R^3) / V$	0.9885

Model solution

As shown in table 3, the model of target fertilizer amount Q can be considered as a cubic equation for rotational speed which involves known variables of exposure length L and operating speed V . The model can be solved by using Shengjin discriminant function and Shengjin equation.

The solving procedure of Shengjin equation is the following: for cubic equation $aX^3 + bX^2 + cX + d = 0$ ($a, b, c, d \in R$, and $a \neq 0$), the multiple root discriminant function is $A = b^2 - 3ac$, $B = bc - 9ad$, $C = c^2 - 3bd$, the final discriminant function is $\Delta = B^2 - 4AC$.

The roots of equation were decided by the positive or negative value of discriminant function.

According to Shengjin equation, the general form of cubic equation for rotational speed is expressed as follows:

$$0.0027R^3 - 0.246R^2 + 5.2035R + 1.885LR + 4.8096L - 31.6916 - QV = 0 \tag{3}$$

The simplified discriminant function is expressed as follows:

$$\Delta = 5.9049 \times 10^{-4} Q^2 V^2 + 0.217L^3 + 1.4909L^2 + 0.0294QV - 0.0733QVL - 0.8847L - 0.0109 \tag{4}$$

The discriminant function is a ternary quartic polynomial, of which is difficult to judge the monotonicity by taking the partial derivatives method. Traversal algorithm was used to calculate the value of discriminant function, the range of target fertilizer amount Q , operating speed V and exposure length L is 80~400kg/hm², 3~6 km/h and 10 ~24 cm, respectively. The step of each variable was 0.1, the flowchart was showed in fig. 5.

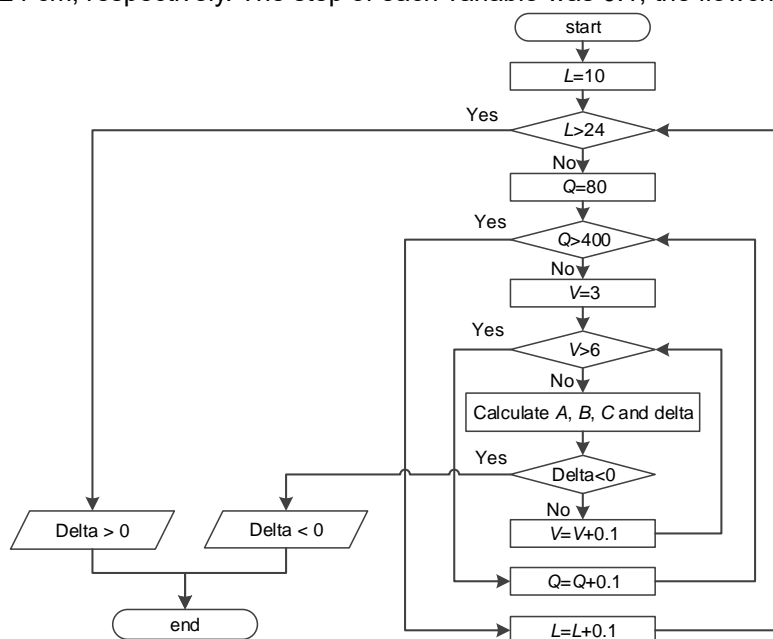

Fig. 5 - Traversal algorithm flowchart for delta discriminant

The results indicated that the value of discriminant is always greater than 0 within the given range, which means there is only one real root for the cubic equation. The root is expressed as follows:

$$X_1 = \frac{-b - (\sqrt[3]{Y_1} + \sqrt[3]{Y_2})}{3a} \tag{5}$$

of which, $Y_{1,2} = Ab + 3a \left(\frac{-B \pm \sqrt{B^2 - 4AC}}{2} \right)$.

The calculation results proved that within the given range, when target fertilizer amount Q and operating speed V is given, the equation has unique solution of rotational speed R at any given exposure length L .

Interfaces for static calibration tests and solving nearly-optimal set

The interfaces based on the flowchart of control method in fig.4 were embedded in the vehicle terminal, which can be used for static calibration tests and dynamic operation tests, as showed in fig.6. for static tests in 6(a), the fertilizer discharge rate q and coefficient of variation CV can be solved with given exposure length L and rotational speed R , for the dynamic operation tests in 6(b), with given operating speed V and target fertilizer amount Q , the nearly-optimal set of exposure length L and rotational speed R was solved, meanwhile, the related fertilizer discharge rate q and coefficient of variation CV was solved.

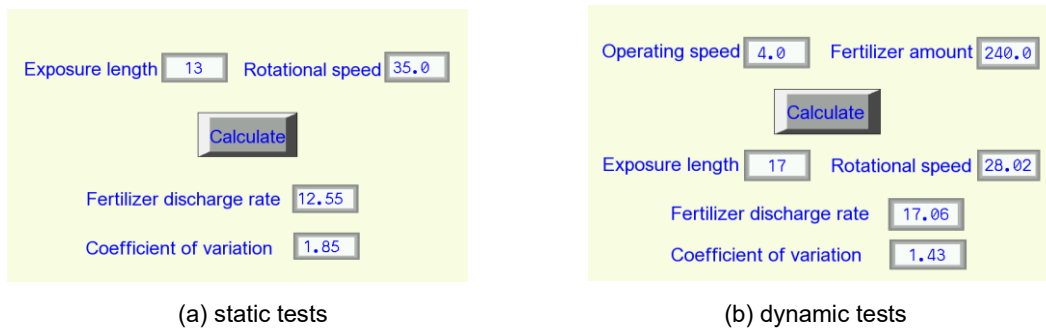

Fig. 4 - Interfaces for control method

Verification experiments design

The experiments under static and dynamic condition were conducted to verify the reliability and accuracy of models and control method.

The regression models of fertilizer discharge rate q and coefficient of variation CV was verified under static condition; 9 groups data were collected when exposure length L set at 14, 18 and 22 mm, rotational speed set at 22, 30 and 35 r/min.

The control method for nearly-optimal set was verified under dynamic condition. The experiment field is 100×3m², 5 groups of selected operating speed [km/h] and target fertilizer amount [kg/hm²] (5, 200), (3, 200), (3, 120), (5, 120) and (4, 200) were conducted with the recommended set of exposure length L and rotational speed R calculated by interface 4(b), the rotational speeds were measured by CAN bus recorder in real time. 2 groups of (5, 200) and (5, 120) were conducted with practical exposure length as control group; the fertilizer applicator and field experiments were shown in fig.5.



Fig. 5 - Experiments under dynamic condition

RESULTS

Regression models verification under static condition

The data of fertilizer discharge rate and coefficient of variation tested under static condition was compared to the data calculated by the interface 4(a), the results were analysed in table 4.

Table 4

Experimental results under static condition

L [mm]	R [r/min]	q [g/r]			CV [%]		
		C-value	T-value	D-value	C-value	T-value	D-value
14	22	14.52	14.32	-0.2	2.32	2.93	0.61
14	30	13.78	13.79	0.01	1.78	2.59	0.81
14	35	13.56	13.48	-0.08	1.66	2.04	0.38
18	22	18.81	18.66	-0.15	1.76	2.23	0.47
18	30	17.92	17.9	-0.02	1.23	1.76	0.53
18	35	17.6	17.55	-0.05	1.11	1.66	0.55
22	22	23.09	23.31	0.22	1.51	3.79	2.28
22	30	22.04	21.99	-0.05	0.99	2.07	1.08
22	35	21.62	21.56	-0.06	0.87	1.83	0.96

Note: C-value is calculated value; T-value is tested value; D-value is difference value.

As shown in table 4, under static condition, the fertilizer discharge rate obtained from experiments are basically uniform compared with the values calculated by regression models. The largest difference value is 0.22g per revolution, the difference values of q were less than 0.1g per revolution in 6 groups. The CV values obtained from experiments has the same trend as the CV values calculated by the models, the CV values decreased with the increase of rotational speed at the same opening length level. The biggest difference value is 2.28% at the opening length of 22mm with the rotational speed of 22r/min. The difference values of CV values in 7 groups are less than 1.

The results showed that regression models have good prediction accuracy for fertilizer discharge rate q and coefficient of variation CV.

Control method of nearly-optimal set verification

Under dynamic condition, the applied fertilizer amount Q_t , deviation of applied fertilizer amount D_t , coefficient of variation CV, average rotational speed R_A and deviation of rotational speed D_R were analysed, the deviation of applied fertilizer amount was compared to the control group and the results were shown in table 5.

Table 5

Experimental results under dynamic condition

groups	V	Q	L	q	Q_t	D_Q	CV[%]		R_A [r/min]		D_R
	[km/h]	[kg/hm ²]	[mm]	[g/r]	[kg/hm ²]	[%]	C-value	T-value	C-value	T-value	%
E-group	5	200	18	18.2	207.67	3.83	1.38	3.89	27.46	27.35	-0.44
	3	200	13	13.44	200	0	2.51	4.17	22.26	21.64	-2.74
	3	120	15	17.64	124.8	4.01	3.76	5.01	10.23	10.11	-1.17
	5	120	13	13.44	118.52	1.23	2.51	3.53	22.26	22.64	1.75
	4	200	16	16.42	193.57	3.21	1.82	5.78	24.37	23.77	-2.46
C-group	5	120	12	12.56	128.42	7.02	-	4.07	-	-	-
	5	200	15	15.02	211.06	5.53	-	4.81	-	-	-

Note: E-group means experimental group; C-group means the control group.

For 5-group experiments conducted by using control method, the deviation of applied fertilizer amount is less than 4.01%, the coefficient of variation is within 3.53 to 5.78%, which could meet the fertilizing accuracy requirements of JB/T7864—2013 *Cultivator-fertilizer*.

The CV values obtained from experiments are larger than the CV values calculated by the control method, which is caused by applicator vibration under dynamic condition. Tested CV values are less than the CV values in control group. The largest deviation of rotational speed is 2.74%, which means the control method has high reliability for rotational speed controlling.

When operating speed is 5 km/h, target fertilizer amount is 120 kg/hm² and 200 kg/hm², the deviations of applied fertilizer amount calculated by the control method are 1.23% and 3.83%, which decreased by 5.79% and 1.71% compared to the control groups, respectively. In control groups, the fertilizer discharge rate q is obtained from static calibration, in which case, there is a difference value because of the uncertain operating rotational speed, which it will cause a larger fertilizer amount deviation. The fertilizer discharge rate q obtained from the control method is calculated based on the practical rotational speed, which highly improved the fertilization accuracy.

CONCLUSIONS

The control method for fertilizer parameters coordinate match was proposed to improve the fertilizer accuracy during topdressing process for winter wheat. Take coefficient of variation as criterion, the nearly-optimal set of exposure length and rotational speed was solved based on target fertilizer amount and operating speed.

The interfaces were built to rapidly calculate the parameters' values, the experiments were carried out to verify the reliability of the regression models and control method. The results showed that the regression models have great prediction for fertilizer discharge rate and coefficient of variation under static conditions, the largest difference value for fertilizer discharge rate being 0.22g per revolution. Under dynamic conditions, fertilization accuracy is highly improved by using the control method, the fertilizer deviations are less than 4.01%, the largest deviation for rotational speed is 2.74%; compared with the control groups at the same experimental condition, the fertilizer deviations are decreased by 5.79% and 1.71%, respectively.

This control method provides nearly-optimal set of exposure length and rotational speed and corresponding fertilizer discharge rate of fluted roller fertilizer apparatus. Meanwhile, it avoids tedious calibration tests before each fertilizing operation. This control method is practical and feasible for fertilizer parameters settings, which can be extended to other types of fertilizer apparatus.

ACKNOWLEDGEMENT

The research is funded by National Key Research and Development Program of China (2016YFD0200600). I would like to express my gratitude to my colleagues from Beijing Research Centre for Information Technology in Agriculture for helping me to conduct the experiments.

REFERENCES

- [1] Benjamin E., Anatha Krishnan D., Kavitha R., (2019), Development of Fertilizer Broadcaster with Electronically Controlled Fluted Roller Metering Mechanism for Paddy Crop. *International Journal of Current Microbiology and Applied Sciences*, Vol.8, Issue.4, pp.2694-2703, Tamil Nadu/India;
- [2] Botao Wang, Lu Bai, Shangpeng Ding et al, (2017), Simulation and experimental study on impact of fluted-roller fertilizer key parameters on fertilizer amount. *Journal of Chinese Agricultural Mechanization*, Vol.38, Issue.10, pp.1-6,23, Beijing/China;
- [3] Chunying Liang, Peng Lv, Jianwei Ji et al, (2013), Application of fuzzy self-tuning PID algorithm in variable rate fertilization system. *Journal of Shenyang Agricultural University*, Vol.44, Issue.4, pp.461-466, Shenyang/China;
- [4] Efreteui A., Gooding M., White E. et al, (2016), Effect of nitrogen fertilizer application timing on nitrogen use efficiency and grain yield of winter wheat in Ireland[J]. *Irish Journal of Agricultural and Food Research*, Vol.55, Issue.1, pp.63-73, Dublin/Ireland;
- [5] Gómez-Gil J., de-Lózar-Escudero A., Navas-Gracia L et al, (2009), Analytical estimation of optimal operation variables of a centrifugal fertilizer distributor, using the gradient method on multiple seeds. *Agrociencia*, Vol.43, Issue.5, pp.497-509, Montecillo/Mexico;
- [6] Huimin Feng, Nana Gao, Zhijun Meng et al, (2018), Design and experiment of deep fertilizer applicator based on autonomous navigation for precise row-following. *Transactions of the Chinese Society for Agricultural Machinery*, Vol.49, Issue.4, pp.60-67, Beijing/China;
- [7] Liping Chen, Wenqian Huang, Zhijun Meng et al, (2008), Design of variable rate fertilization controller based on CAN bus. *Transactions of the Chinese Society for Agricultural Machinery*, Vol.39, Issue.8, pp.101-104, Beijing/China;

- [8] Man Chen, Wei Lu, Xiaochan Wang et al, (2016), Design and experiment of optimization control system for variable fertilization in winter wheat field based on fuzzy PID. *Transactions of the Chinese Society for Agricultural Machinery*, Vol.47, Issue.2, pp.71-76, Beijing/China;
- [9] Ning Su, Taosheng Xu, Liangtu Song et al, (2015), Variable rate fertilization system with adjustable active feed-roll length. *International Journal of Agricultural and Biological Engineering*, Vol.8, Issue.4, pp.19-26, Beijing/China;
- [10] Qingzhen Zhu, Guangwei Wu, Liping Chen et al, (2018), Influences of structure parameters of straight flute wheel on fertilizing performance of fertilizer apparatus. *Transactions of the CSAE*, Vol.34, Issue.18, pp.12-20, Beijing/China.
- [11] Rui Zhang, Chunjiang Zhao, Xiu Wang et al, (2012), A Variable-Rate Fertilizer Control System for Disc Fertilizer Spreaders. *Intelligent Automation & Soft Computing*, Vol.18, Issue.5, pp.461-467, London/U.K.;
- [12] Shiqiang Pan, Yaxiang Zhao, Liang JIN et al, (2016), Design and experimental research of external grooved wheel fertilizer apparatus of 2BFJ-6 type variable rate fertilizer applicator. *Journal of Chinese Agricultural Mechanization*, Vol.37, Issue.1, pp.40-42, Nanjing/China;
- [13] Yuxue Gu, Jin Yuan, Chengliang Liu, (2011), FIS-based method to generate bivariate control parameters regulation sequence for fertilization. *Transactions of the CSAE*, Vol.27, Issue.11, pp.134-139, Beijing/China;
- [14] Zhongyang Huo, Xin Ge, Hongcheng Zhang et al, (2004), Effect of different nitrogen application types on N-absorption and N-utilization rate of specific use cultivars of wheat. *Acta Agronomica Sinica*, Vol.30, Issue.5, pp.449-454, Beijing/China.